

PowerBuilder Native Interface Programmers Guide and Reference

Appeon PowerBuilder® 2017 R2
FOR WINDOWS

DOCUMENT ID: DC37794-01-1700-01

LAST REVISED: January 26, 2018

Copyright © 2018 by Appeon Limited. All rights reserved.

This publication pertains to Appeon software and to any subsequent release until otherwise indicated in new editions or technical notes. Information in this document is subject to change without notice. The software described herein is furnished under a license agreement, and it may be used or copied only in accordance with the terms of that agreement.

Upgrades are provided only at regularly scheduled software release dates. No part of this publication may be reproduced, transmitted, or translated in any form or by any means, electronic, mechanical, manual, optical, or otherwise, without the prior written permission of Appeon Limited.

Appeon and other Appeon products and services mentioned herein as well as their respective logos are trademarks or registered trademarks of Appeon Limited.

SAP and other SAP products and services mentioned herein as well as their respective logos are trademarks or registered trademarks of SAP and SAP affiliate company.

Java and all Java-based marks are trademarks or registered trademarks of Oracle and/or its affiliates in the U.S. and other countries.

Unicode and the Unicode Logo are registered trademarks of Unicode, Inc.

All other company and product names mentioned may be trademarks of the respective companies with which they are associated.

Use, duplication, or disclosure by the government is subject to the restrictions set forth in subparagraph (c)(1)(ii) of DFARS 52.227-7013 for the DOD and as set forth in FAR 52.227-19(a)-(d) for civilian agencies.

Appeon Limited, 1/F, Shell Industrial Building, 12 Lee Chung Street, Chai Wan District, Hong Kong

Contents

I	Programmers Guide	1
1	Introduction to PBNI	2
1.1	About PBNI	2
1.1.1	Understanding PowerBuilder extensions	2
1.1.2	Embedding the PBVM in a C++ application	4
1.2	The elements of PBNI	4
1.3	The PBNI SDK	6
1.4	Comparing PBNI and JNI	7
2	Building PowerBuilder Extensions	8
2.1	Nonvisual extension example	8
2.1.1	Building the pbadd PowerBuilder extension	8
2.1.2	Using the extension in PowerBuilder	11
2.2	Creating a PowerBuilder extension	12
2.2.1	Step 1: Decide on a feature to implement	13
2.2.2	Step 2: Define the classes and functions in the extension	13
2.2.3	Step 3: Declare native classes and global functions	15
2.2.4	Step 4: Implement native classes and global functions	16
2.2.5	Step 5: Export methods to create class instances	17
2.2.6	Step 6: Build a PBX	18
2.3	Adding an extension to a PowerBuilder target	18
2.4	Using the extension	19
2.5	Creating and using a visual extension	20
2.5.1	Step 1: Decide on a feature to implement	20
2.5.2	Step 2: Define the classes and functions in the extension	20
2.5.3	Step 3: Declare visual classes and global functions	21
2.5.4	Step 4: Implement native classes	21
2.5.5	Step 5: Export methods to create class instances	21
2.5.6	Step 6: Build and use a PBX	21
2.5.7	Step 7: Use the visual extension in an application	21
2.6	Creating visual class instances	22
2.7	Event processing in visual extensions	24
2.7.1	Using an event name with return type and arguments	24
2.7.2	Using an event name with a PowerBuilder event ID	26
2.7.3	Processing events sent to the parent of the window	26
2.8	Calling PowerScript from an extension	28
2.8.1	Example: Calling PowerBuilder functions	30
2.9	Exception handling and debugging	30
3	Creating Marshaler Extensions	32
3.1	About marshaler extensions	32
3.2	Developing the PowerBuilder extension	32
3.2.1	Step 1: Describe the extension	33
3.2.2	Step 2: Implement the creator class	34
3.2.3	Step 3: Implement the marshaler class	36
3.3	Generating proxies for Java classes	37
3.4	Calling the Java class from PowerBuilder	38
4	Exchanging Data with PowerBuilder	39

4.1	About exchanging data with PowerBuilder	39
4.2	Passing values between extensions and the PBVM	39
4.2.1	PBColumnInfo structure	39
4.2.2	IPB_Arguments interface	39
4.2.3	IPB_Value interface	40
4.3	Using the IPB_Session interface	41
4.4	Saving data from IPB_Value to a local variable	43
4.5	Using variables throughout a session	45
4.6	Handling enumerated types	45
5	Calling PowerBuilder from C++	47
5.1	About calling PowerScript from C++ applications	47
5.2	Calling PowerBuilder objects from C++	47
5.2.1	Creating a PowerBuilder object to be called from C++	48
5.2.2	Getting the signature of a function	48
5.2.3	Creating the C++ application	49
5.2.3.1	Load the PowerBuilder VM	50
5.2.3.2	Call PB_GetVM to get a pointer to the IPB_VM interface	50
5.2.3.3	Create an IPB_Session object within IPB_VM	50
5.2.3.4	Create an instance of the PowerBuilder object	50
5.2.3.5	Initialize the PColumnInfo structure	51
5.2.3.6	Call the PowerBuilder function	51
5.2.3.7	Write cleanup code	52
5.2.4	Running the C++ application	52
5.3	Accessing result sets	52
5.4	Processing PowerBuilder messages in C++	52
5.4.1	Examples	53
5.5	More PBNI possibilities	56
II	Reference	58
6	PBNI Types and Return Values	59
6.1	PowerBuilder to PBNI datatype mappings	59
6.2	Types for access to PowerBuilder data	59
6.3	PBNI enumerated types	60
6.4	Error return values	61
7	PBNI Interfaces, Structures, and Methods	63
7.1	Header file contents	63
7.2	Class and interface summary	63
7.3	IPB_Arguments interface	66
7.3.1	GetAt	66
7.3.2	GetCount	67
7.4	IPB_ResultSetAccessor interface	67
7.4.1	AddRef	68
7.4.2	GetColumnCount	68
7.4.3	GetColumnMetaData	68
7.4.4	GetItemData	69
7.4.5	GetRowCount	70
7.4.6	Release	71
7.5	IPB_RSItemData interface	71

7.5.1	SetData	71
7.5.2	SetNull	72
7.6	IPB_Session interface	72
7.6.1	AcquireArrayItemValue	80
7.6.2	AcquireValue	81
7.6.3	Add<type>Argument	82
7.6.4	AddGlobalRef	84
7.6.5	AddLocalRef	84
7.6.6	ClearException	85
7.6.7	CreateResultSet	85
7.6.8	FindClass	88
7.6.9	FindClassByClassID	88
7.6.10	FindGroup	89
7.6.11	FindMatchingFunction	89
7.6.12	FreeCallInfo	91
7.6.13	Get<type>ArrayItem	91
7.6.14	Get<type>Field	93
7.6.15	Get<type>GlobalVar	94
7.6.16	Get<type>SharedVar	95
7.6.17	GetArrayInfo	96
7.6.18	GetArrayItemType	97
7.6.19	GetArrayLength	98
7.6.20	GetBlob	99
7.6.21	GetBlobLength	99
7.6.22	GetClass	100
7.6.23	GetClassName	101
7.6.24	GetCurrGroup	101
7.6.25	GetDateString	102
7.6.26	GetDateTimeString	102
7.6.27	GetDecimalString	103
7.6.28	GetEnumItemName	104
7.6.29	GetEnumItemValue	104
7.6.30	GetException	105
7.6.31	GetFieldID	105
7.6.32	GetFieldName	106
7.6.33	GetFieldType	107
7.6.34	GetGlobalVarID	108
7.6.35	GetGlobalVarType	108
7.6.36	GetMarshaler	109
7.6.37	GetMethodID	110
7.6.38	GetMethodIDByEventID	111
7.6.39	GetNativeInterface	112
7.6.40	GetNumOfFields	113
7.6.41	GetPBAnyArrayItem	113
7.6.42	GetPBAnyField	114
7.6.43	GetPBAnyGlobalVar	116
7.6.44	GetPBAnySharedVar	116
7.6.45	GetProp	117

7.6.46	GetResultSetAccessor	117
7.6.47	GetSharedVarID	118
7.6.48	GetSharedVarType	119
7.6.49	GetString	120
7.6.50	GetStringLength	121
7.6.51	GetSuperClass	121
7.6.52	GetSystemClass	122
7.6.53	GetSystemGroup	122
7.6.54	GetTimeString	123
7.6.55	HasExceptionThrown	123
7.6.56	HasPBVisualObject	124
7.6.57	InitCallInfo	125
7.6.58	InvokeClassFunction	126
7.6.59	InvokeObjectFunction	127
7.6.60	IsArrayItemNull	128
7.6.61	IsAutoInstantiate	128
7.6.62	IsFieldArray	129
7.6.63	IsFieldNull	129
7.6.64	IsFieldObject	130
7.6.65	IsGlobalVarArray	131
7.6.66	IsGlobalVarNull	132
7.6.67	IsGlobalVarObject	132
7.6.68	IsNativeObject	133
7.6.69	IsSharedVarArray	134
7.6.70	IsSharedVarNull	135
7.6.71	IsSharedVarObject	135
7.6.72	NewBlob	136
7.6.73	NewBoundedObjectArray	137
7.6.74	NewBoundedSimpleArray	138
7.6.75	NewDate	139
7.6.76	NewDateTime	139
7.6.77	NewDecimal	140
7.6.78	NewObject	141
7.6.79	NewProxyObject	141
7.6.80	NewString	142
7.6.81	NewTime	143
7.6.82	NewUnboundedObjectArray	143
7.6.83	NewUnboundedSimpleArray	144
7.6.84	PopLocalFrame	145
7.6.85	ProcessPBMessage	146
7.6.86	PushLocalFrame	147
7.6.87	Release	147
7.6.88	ReleaseArrayInfo	147
7.6.89	ReleaseDateString	148
7.6.90	ReleaseDateTimeString	149
7.6.91	ReleaseDecimalString	149
7.6.92	ReleaseResultSetAccessor	149
7.6.93	ReleaseString	150

7.6.94	ReleaseTimeString	151
7.6.95	ReleaseValue	151
7.6.96	RemoveGlobalRef	152
7.6.97	RemoveLocalRef	153
7.6.98	RemoveProp	153
7.6.99	RestartRequested	154
7.6.100	Set<type>ArrayItem	155
7.6.101	Set<type>Field	157
7.6.102	Set<type>GlobalVar	158
7.6.103	Set<type>SharedVar	159
7.6.104	SetArrayItemToNull	160
7.6.105	SetArrayItemValue	160
7.6.106	SetBlob	161
7.6.107	SetDate	161
7.6.108	SetDateTime	162
7.6.109	SetDecimal	163
7.6.110	SetFieldToNull	164
7.6.111	SetGlobalVarToNull	164
7.6.112	SetMarshaler	165
7.6.113	SetProp	166
7.6.114	SetSharedVarToNull	167
7.6.115	SetString	168
7.6.116	SetTime	169
7.6.117	SetValue	170
7.6.118	SplitDate	171
7.6.119	SplitDateTime	171
7.6.120	SplitTime	172
7.6.121	ThrowException	173
7.6.122	TriggerEvent	174
7.6.123	UpdateField	175
7.7	IPB_Value interface	175
7.7.1	Get<type>	176
7.7.2	GetClass	177
7.7.3	GetType	177
7.7.4	IsArray	178
7.7.5	IsByRef	179
7.7.6	IsEnum	179
7.7.7	IsNull	179
7.7.8	IsObject	180
7.7.9	Set<type>	181
7.7.10	SetToNull	182
7.8	IPB_VM interface	183
7.8.1	CreateSession	183
7.8.2	RunApplication	184
7.9	IPBX_Marshaler interface	185
7.9.1	Destroy	185
7.9.2	GetModuleHandle	186
7.9.3	InvokeRemoteMethod	187

7.10	IPBX_NonVisualObject interface	188
7.11	IPBX_UserObject interface	189
7.11.1	Destroy	189
7.11.2	Invoke	189
7.12	IPBX_VisualObject interface	190
7.12.1	CreateControl	191
7.12.2	GetEventID	192
7.12.3	GetWindowClassName	194
7.13	PBArrayInfo structure	195
7.14	PBCallInfo structure	195
7.15	PB_DateData structure	196
7.16	PB_DateTimeData structure	196
7.17	PB_TimeData structure	196
7.18	PBX_DrawItemStruct structure	197
7.19	PBArrayAccessor template class	198
7.19.1	GetAt	198
7.19.2	IsNull	199
7.19.3	SetAt	199
7.19.4	SetToNull	200
7.20	PBBoundedArrayCreator template class	201
7.20.1	GetArray	201
7.20.2	SetAt	202
7.21	PBBoundedObjectArrayCreator class	203
7.21.1	GetArray	204
7.21.2	SetAt	204
7.22	PBObjectArrayAccessor class	205
7.22.1	GetAt	205
7.22.2	SetAt	206
7.23	PBUnboundedArrayCreator template class	206
7.23.1	GetArray	207
7.23.2	SetAt	207
7.24	PBUnboundedObjectArrayCreator class	208
7.24.1	GetArray	208
7.24.2	SetAt	208
7.25	Exported methods	209
7.25.1	PBX_CreateNonVisualObject	209
7.25.2	PBX_CreateVisualObject	211
7.25.3	PBX_DrawVisualObject	212
7.25.4	PBX_GetDescription	213
7.25.5	PBX_InvokeGlobalFunction	215
7.25.6	PBX_Notify	217
7.26	Method exported by PowerBuilder VM	217
7.26.1	PB_GetVM	218
8	PBNI Tool Reference	220
8.1	pbsig170	220
8.2	pbx2pbd170	222
III	Appendix	224
9	APPENDIX A Using the Visual Studio Wizards	225

9.1 Where the wizards are installed	225
9.1.1 Generating a PBNI project	226
9.1.2 Setting project options	226
9.1.3 Building and using the PBX	227
Index	228

Part I. Programmers Guide

This part provides an introduction to the PowerBuilder Native Interface and a guide to creating PowerBuilder extensions and interacting with PowerBuilder.

1 Introduction to PBNI

About this chapter

This chapter provides a brief introduction to the PowerBuilder Native Interface.

1.1 About PBNI

PBNI is a standard programming interface that enables developers to extend the functionality of PowerBuilder. Using PBNI, you can create extensions to PowerBuilder -- nonvisual, visual, and marshaler extensions -- and embed the PowerBuilder virtual machine (PBVM) into C++ applications. Through the Java Native Interface (JNI) and PBNI, Java applications can also communicate with the PBVM.

Code samples

This documentation contains two complete but very simple examples that illustrate some basic principles of using the PowerBuilder Native Interface (PBNI): [Nonvisual extension example](#) and [Creating a PowerBuilder object to be called from C++](#). For more real-world examples, see the PBNI section of the PowerBuilder Code Samples Web site at <https://www.appeon.com/developers/library/code-samples-for-pb>.

The following diagram illustrates the two-way communication, with both PowerBuilder extensions and external applications, that PBNI provides for the PBVM. As the diagram shows, a PowerBuilder extension communicates with the PBVM through the IPB_Session interface, and the PBVM communicates with the extension through an interface derived from IPBX_UserObject.

C++ and Java extensions communicate with the PBVM through the IPB_VM and IPB_Session interfaces.

Figure: Interaction between the PBVM and external applications and extensions

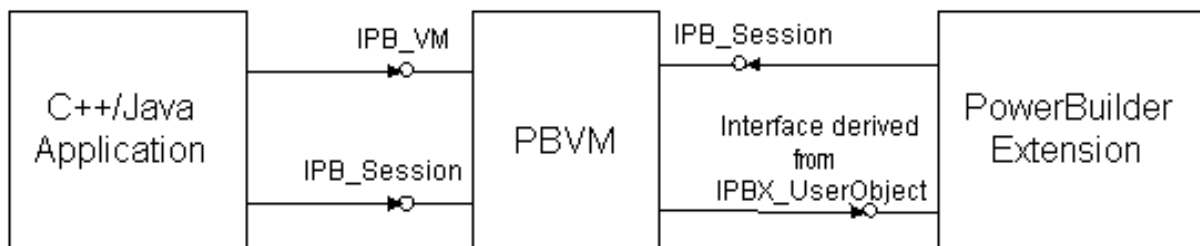

1.1.1 Understanding PowerBuilder extensions

A PowerBuilder extension is just what its name suggests: an extension to PowerBuilder functionality provided by you, by a third party, or by Apeon. All PowerBuilder extensions communicate with the PBVM through an interface called IPB_Session. This interface and other PBNI objects and interfaces are described in [The elements of PBNI](#).

PowerBuilder provides its own extensions, including a PBDOM XML parser and classes that support SOAP clients for Web services. In future releases, Apeon might develop more new features as PBNI extensions instead of embedding them in the PowerBuilder VM (PBVM), so that the size of the PBVM can be minimized. Extensions are also available from third party contributors; for the latest samples and utilities, see the PBNI section of the

PowerBuilder Code Samples Web site at <https://www.appeon.com/developers/library/code-samples-for-pb>.

Nonvisual extensions

The most frequently used type of PowerBuilder extension is a nonvisual extension. Nonvisual extensions provide a way to call C and C++ functions from PowerBuilder with more flexibility than the previous solution of declaring a function in a script. They also allow you to use object-oriented techniques when working with external objects.

A nonvisual extension is a DLL, written in C++, that exposes one or more native classes and/or global functions. Classes are used in a PowerBuilder application as though they were class user objects created in PowerBuilder -- a native class is simply a PowerScript class that is implemented in C++. Global functions in an extension are used like global functions declared in the Function painter.

Nonvisual extensions allow you to use datatypes in C++ that map to standard PowerBuilder datatypes. PBNI provides predefined datatypes that map to PowerBuilder datatypes, so that you can use PowerBuilder datatypes when you invoke the methods of the native class, and the native class can use predefined types to call back into PowerBuilder. For more information about predefined types, see [PBNI Types and Return Values](#)

You can use native classes to call back into the PBVM from the C++ code and trigger PowerBuilder events and invoke functions. You can also call external functions that require callback functions. For example, if your PowerBuilder application uses an extension that is a SAX XML parser, the SAX parser can send information back to the PowerBuilder application about the items it has encountered in the XML document that it is parsing. In response, the PowerBuilder application can send back instructions on how to handle those items.

Possible uses for a nonvisual extension include:

- A wrapper for a Component Object Model (COM) component that references a user-defined COM interface that cannot be mapped to a PowerBuilder datatype
- A PowerBuilder interface for database backups and administration using the SQL Anywhere dbtools (which require callback functions)
- Wrappers for any open source C++ libraries that provide standard utilities

PowerBuilder extensions run faster than standard PowerBuilder user objects because they are compiled in native machine code instead of PowerBuilder pseudocode (Pcode). PBNI complies with the C++ specification, so well-programmed code is portable at the source code level.

Visual extensions

Visual extensions can be used as if they were PowerBuilder visual user objects -- you can place them in windows or on other visual controls. Visual extensions allow you to create a subclass of the Windows procedure (winproc) of a visual component so that you can use the latest "look and feel" for your applications.

Marshaler extensions

Marshaler extensions act as bridges between PowerBuilder and other components, such as Enterprise JavaBeans (EJB) components, Java classes, Web services, and CORBA

components. PowerBuilder provides a marshaler extension for creating clients for EJB components running in any J2EE-compliant application server. Other techniques for calling EJBs from PowerBuilder do not provide a standard way to marshal PowerBuilder requests to other components and unmarshal the result back to PowerBuilder.

1.1.2 Embedding the PBVM in a C++ application

Many PowerBuilder users have developed sophisticated custom class user objects that handle intensive database operations or other functionality. Such objects can already be used in external applications. However, limitations on the use of some datatypes and of overloaded functions, as well as other coding restrictions, diminishes the value of this technique.

To have direct access to a custom class user object running in the PBVM, and to take advantage of PBNI functions for data access and exchange, you can load the PBVM in the C++ application, create a session, and invoke the custom class user object's functions from the external application.

Communication between the PBVM and a C++ application is based primarily on two interfaces: `IPB_VM` and `IPB_Session`.

Interacting with Java

To call Java classes from PowerBuilder, you can build a marshaler extension that invokes Java methods through JNI, as described in [Creating Marshaler Extensions](#). You can also use JNI to allow Java to call into PowerBuilder through C or C++. For an example, see the PowerBuilder Code Samples Web site at <https://www.appeon.com/developers/library/code-samples-for-pb>.

1.2 The elements of PBNI

To enable the features described in the previous section, PBNI provides interfaces, structures, global functions, and helper classes. These elements are described in more detail in the reference section of this guide. See [PBNI Interfaces, Structures, and Methods](#). This section provides an overview.

Interfaces

The `IPB_VM` interface is used to load PowerBuilder applications in third-party applications and interoperate with the PowerBuilder virtual machine (PBVM).

`IPB_Session` is an abstract interface that defines methods for performing various actions such as accessing PowerScript data, creating PowerBuilder objects, and calling PowerScript functions.

The `IPB_Value` and `IPB_Arguments` interfaces enable you to pass values between the PowerBuilder VM and PowerBuilder extension modules.

The `IPB_Value` interface represents a PowerBuilder value, which could be one of the PowerBuilder standard datatypes such as integer, long, string, and so forth. It provides information about each variable, including its type, null flag, access privileges, array or simple type, and reference type.

The `IPB_Arguments` interface represents the arguments passed to a PowerScript function and is used to access the data.

The `IPB_ResultSetAccessor` and `IPB_RSItemData` interfaces enable you to access data in a `DataWindow` or `DataStore`.

All PowerBuilder native classes inherit from the `IPBX_NonVisualObject` interface or the `IPBX_VisualObject` interface, which in turn inherit from the `IPBX_UserObject` interface. You must implement the `Invoke` method in the inherited class to enable PowerBuilder to invoke methods in the native class.

Marshaler extensions contain a class that inherits from the `IPBX_Marshaler` interface. You must implement the `InvokeRemoteMethod` method in the inherited class to enable PowerBuilder to invoke methods on remote objects represented by a proxy.

Structures

The `PBCallInfo` structure holds arguments and return type information for function calls between PBNI and PowerBuilder. To access the information in `PBCallInfo`, use the `IPB_Arguments` interface.

The `PBArrayInfo` structure stores information about arrays.

The `PB_DateData`, `PB_TimeData`, and `PB_DateTimeData` structures are used to pass `DataWindow` and `DataStore` data.

Global functions

Every PowerBuilder extension object must export global functions that enable the PowerBuilder VM to create instances of the object and use its methods. The `PBX_GetDescription` function describes the classes and functions in the extension. The `PBX_CreateNonVisualObject` function enables the PBVM to create instances of the nonvisual classes in an extension, and the `PBX_CreateVisualObject` function does the same for visual classes.

Helper classes

Several helper classes, such as `PBObjectCreator`, `PBArrayAccessor`, and `PBEventTrigger`, make it easier to program with PBNI.

Interaction between an extension and the PBVM

The following diagram summarizes how an extension interacts with the PBVM.

Figure: Interaction between an extension and the PowerBuilder VM

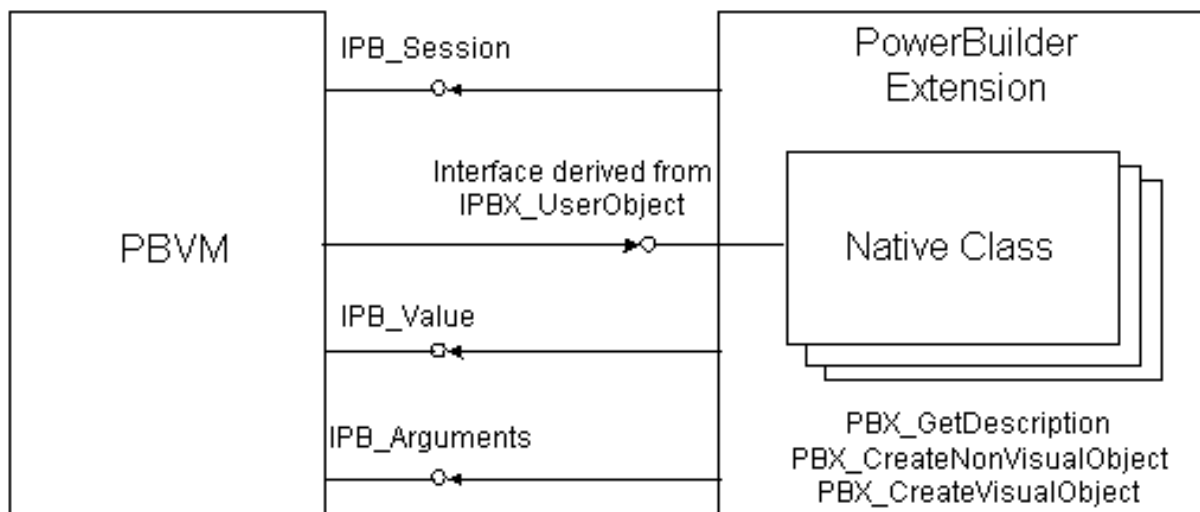

1.3 The PBNI SDK

When you install PowerBuilder, the Software Development Kit (SDK) for PBNI is installed in the PowerBuilder 17.0\SDK\PBNI directory. The SDK tools, pbsig170 and pbx2pbd170, are also installed in the Shared\PowerBuilder directory so that they are available in your path.

The SDK contains the components shown in the following table.

Table 1.1: Contents of the PBNI SDK

Component	Description
pbx2pbd170.exe	A tool that generates a PBD file from a PowerBuilder extension file. The extension file is a DLL file that must export a set of PBNI functions. The DLL is usually called a PBX and can be given the suffix .pbx.
pbsig170.exe	A tool that generates a set of strings representing the return type and arguments of each function in a PBL. Use these strings to call PowerBuilder functions from external modules.
include\pbni.h	A header file that defines the structures and interfaces used to build PowerBuilder extensions.
include\pbarray.h	A header file that contains helper classes that make it easier to create arrays and access data in them.
include\pbfield.h	A header file that contains helper classes that make it easier to access data in fields.
include\pbtraits.h	A header file used by pbarray.h and pbfield.h that provides specializations for the pbvalue_type enumerated types.
include\pbext.h	A header file that defines the functions that PowerBuilder extension functions must export.
include\pbeventid.h	A header file that maps the PowerBuilder event IDs to event names for use in visual extensions.
include\pbnimd.h	A header file that defines machine-dependent datatypes used in pbni.h.
include\pbrsa.h	A header file that defines interfaces and structures used to access DataWindow and DataStore data.
src\pbarray.cpp	A source file that must be added to your project if you want to use the following helper classes defined in pbarray.h: PBAccessor PBAccessorArray PBArrayCreator PBArrayObjectCreator PBArrayObjectCreator PBArrayObjectCreator
src\pbfuninv.cpp	A source file that must be added to your project if you want to use the following helper classes defined in pbni.h: PBGlobalFunctionInvoker

Component	Description
	PBObjectFunctionInvoker PBEventTrigger
src\pbobject.cpp	A source file that must be added to your project if you want to use the following helper class defined in pbni.h: PBObjectCreator.
wizards \VCProjects 8.0	A Microsoft Visual Studio 2005 wizard that makes it easier for you to create PBNI projects.
wizards \VCProjects 7.1	A Microsoft Visual Studio .NET 2003 wizard that makes it easier for you to create PBNI projects.
wizards \VCProjects 7.0	A Microsoft Visual Studio .NET 2002 wizard that makes it easier for you to create PBNI projects.
wizards \VCWizards	Files required by the Visual Studio wizards.
pbni170.chm	Help file for PBNI.

1.4 Comparing PBNI and JNI

If you have used the Java Native Interface (JNI), which allows Java applications and C and C++ modules to interoperate, you might find it helpful to be aware of the similarities in the two interfaces and the differences between them.

The IPB_VM interface in PBNI is analogous to the JavaVM type, and the IPB_Session interface in PBNI is analogous to JNIEnv. For JNI, you use the javap command to obtain a string that encodes the signature of each method in a native class. For PBNI, the pbsig170 tool performs the same function.

The major difference between the two interfaces is in how a native function or class is declared.

In JNI, you must use the native keyword to declare that a function is native, but you cannot simply declare a class as native. You must define your classes in Java source code, use the javah tool to generate a C header file that defines a C prototype for each native method, then implement the individual C or C++ functions, using #include to include the generated header file.

PBNI provides an object-oriented approach -- you declare a class as native in the C++ code by inheriting from the IPBX_NonVisualObject or IPBX_VisualObject struct.

2 Building PowerBuilder Extensions

About this chapter

This chapter describes how to build a PowerBuilder extension. It begins with a sample application that uses a simple nonvisual extension.

2.1 Nonvisual extension example

To illustrate the principles involved in building and using an extension, this chapter starts with a sample application that uses a PowerBuilder extension to perform a simple arithmetic operation. Ordinarily, this is not a task that needs PBNI, but it is used here to make the basic process clear. The rest of this chapter describes building extensions in more detail.

PBX file suffix

PowerBuilder extensions are DLL files but typically use the file extension .pbx instead of .dll. Your extension is compiled into a PBX file by default if you use the wizard described in [Using the Visual Studio Wizards](#)

For more realistic examples, see the PowerBuilder Code Samples Web site at <https://www.appeon.com/developers/library/code-samples-for-pb>.

The following sample application has two main steps:

- [Building the pbadd PowerBuilder extension](#)
- [Using the extension in PowerBuilder](#)

2.1.1 Building the pbadd PowerBuilder extension

In this example, the C++ code is in three files:

- The class declaration is in a header file, pbadd.h
- The standard functions that every PowerBuilder extension must expose are in main.cpp
- The implementation of the class is in pbadd.cpp.

To implement the pbadd extension:

1. Create the pbadd.h header file.

The pbadd.h header file declares the pbadd class. The file includes pbext.h, which must be included in all PowerBuilder extensions because it declares the ancestor classes for native classes and the standard functions that the extension must expose. Here is the code for pbadd.h:

```
#include "pbext.h"
class pbadd: public IPBX_NonVisualObject
{
public:
    pbadd();
    virtual ~pbadd();
    PBXRESULT Invoke(
```

```

    IPB_Session    *session,
    pbobject       obj,
    pbmethodID    mid,
    PBCallInfo    *ci);

    int f_add(IPB_Session*, pbint, pbint);
// Enum used to provide entry points for each
// method in the class - the only one in this case
// is mAdd    enum MethodIDs
    {
        mAdd = 0
    };

private:
    virtual void Destroy();
};

```

2. Create the main.cpp file, which includes pbadd.h and implements the standard functions, PBX_GetDescription and PBX_CreateNonvisualObject:

- PBX_GetDescription is used to pass the descriptions of classes in the extension to PowerBuilder.
- The PBX_CreateNonVisualObject method creates the object instance. The PowerScript CREATE statement maps to this PBNI method.

The following is the code for main.cpp:

```

#include "pbadd.h"
// initialize the PBX
BOOL APIENTRY DllMain(HANDLE hModule,
                    DWORD ul_reason_for_all,
                    LPVOID lpReserved
                    )
{
    switch(ul_reason_for_all)
    {
        case DLL_PROCESS_ATTACH:
        case DLL_THREAD_ATTACH:
        case DLL_THREAD_DETACH:
        case DLL_PROCESS_DETACH:
            break;
    }
    return TRUE;
}

// describe the pbadd class
PBXEXPORT LPCTSTR PBXCALL PBX_GetDescription()
{
    static const TCHAR desc[]={
        "class pbadd from nonvisualobject \n" \
        "function int f_add(int a,int b)\n" \
        "end class \n"
    };
    return desc;
}

// export the required PBX_CreateNonVisualObject
// function so that the PBVM can
// create an instance of the class

```

```

PBXEXPORT PBXRESULT PBXCALL PBX_CreateNonVisualObject
(
    IPB_Session*    pbSession,
    pbobject        pbobj,
    LPCSTR          xtraName,
    IPBX_NonVisualObject **obj
)
{
    // if the calling function requests the pbadd
    // class, create an instance
    if (strcmp(xtraName,"pbadd")==0)
    {
        *obj=new pbadd;
    }
    return 0;
};

```

3. Create the pbadd.cpp file, which includes pbadd.h and contains the implementation of the pbadd class and its single method, f_add.

```

#include "pbadd.h"

// Implement the required Invoke method
PBXRESULT pbadd:: Invoke(IPB_Session *Session,
    pbobject obj, pbmethodID mid, PBCallInfo *ci)
{
    // if the method to call is f_add
    if (mid == mAdd)
    {
        int sum = f_add(Session, ci->pArgs->GetAt(0)->
            GetInt(), ci->pArgs->GetAt(1)->GetInt());
        ci->returnValue->SetInt(sum);
    }
    return PBX_OK;
}

// constructor and destructor
pbadd:: pbadd()
{
}
pbadd::~ ~pbadd()
{
}

// implement the class's f_add method
int pbadd:: f_add(IPB_Session* session, pbint arg1,
    pbint arg2)
{
    return arg1+arg2;
}

// Implement the required Destroy method
void pbadd::Destroy()
{
    delete this;
}

```

To compile and link the PBX:

- In your C++ development tool or on the command line, compile and link the PBX. Make sure the include directory in PowerBuilder 17.0\SDK\PBNI is in your include path. For this example, the generated DLL is called pbadd.pbx.

2.1.2 Using the extension in PowerBuilder

To use the PowerBuilder native class in a PowerBuilder application, import the object descriptions in the PBX file into a library in your application.

To import the extension into an application:

1. Copy the PBX (or DLL) file to a directory on your application's path.
2. In PowerBuilder, create a new workspace.
3. On the Target page of the New dialog box, select the Application icon to create a new target, library, and application object.
4. In the System Tree, expand the new target, right-click the library, and select Import PB Extension from the pop-up menu.

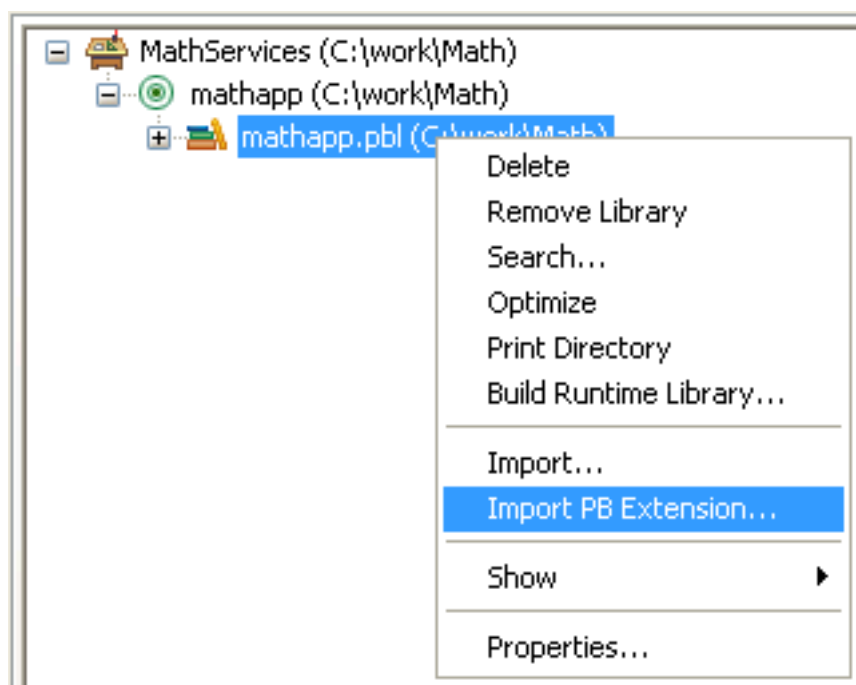

5. Navigate to the location of the pbadd.pbx file and click Open.

To invoke the f_add function in PowerBuilder:

1. Create a new window called w_add, and add three single-line edit boxes and a command button to it.
2. Declare an instance variable called mypbadd for the pbadd native class, and then add this script to the button's Clicked event:

```
TRY
    mypbadd = CREATE pbadd
    sle_3.text = string (mypbadd.f_add( &
        integer(sle_1.text), integer(sle_2.text)))
CATCH (runtimeerror re)
    MessageBox("Error", &
        "pbadd native class could not be created: " + &
```

```
re.getmessage() )  
END TRY
```

The pbadd class displays in the System Tree. As shown in the following screen shot, you can expand its function list:

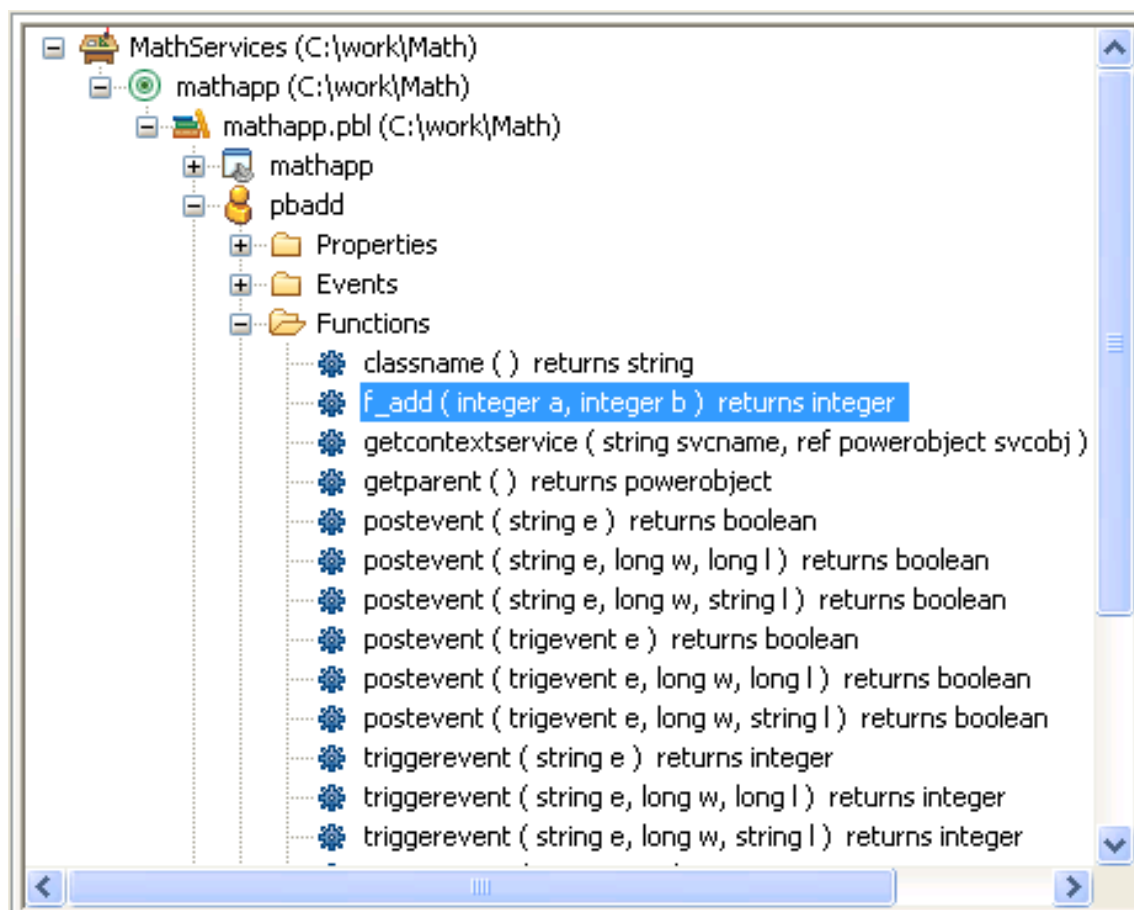

3. Add open(w_add) to the application's Open event.
4. Run the application.

The application runs just as it would if you had created a custom class user object in PowerBuilder with an f_add function. If PowerBuilder cannot find pbadd.pbx, the runtime error in the Clicked event script will be triggered and caught. Put pbadd.pbx in the same directory as the executable or the PowerBuilder runtime DLLs to make sure it can be found.

2.2 Creating a PowerBuilder extension

To build a PowerBuilder extension, follow these steps:

[Step 1: Decide on a feature to implement.](#)

[Step 2: Define the classes and functions in the extension .](#)

[Step 3: Declare native classes and global functions.](#)

[Step 4: Implement native classes and global functions.](#)

[Step 5: Export methods to create class instances.](#)

[Step 6: Build a PBX.](#)

These steps apply whether you are building a nonvisual or a visual extension. The differences between building nonvisual and visual extensions are described in [Creating and using a visual extension](#). This section focuses primarily on nonvisual extensions.

Required methods

All PowerBuilder nonvisual extensions must export two methods: `PBX_GetDescription` and `PBX_CreateNonVisualObject`. The use of these methods is described in [Step 2: Define the classes and functions in the extension](#) and [Step 5: Export methods to create class instances](#).

PowerBuilder visual extensions must export `PBX_GetDescription` and `PBX_CreateVisualObject`. See [Creating and using a visual extension](#).

If the extension declares global functions, it must also export the `PBX_InvokeGlobalFunction` method.

For every native class, you must implement two PBNI methods, `Invoke` and `Destroy`, in addition to the methods the class will provide. The use of these PBNI methods is described in [Step 4: Implement native classes and global functions](#).

2.2.1 Step 1: Decide on a feature to implement

The first step in building a PowerBuilder extension is to identify a problem that an extension can solve. This might be a feature that can be coded more efficiently and easily in C++ than in PowerScript, or that requires the use of callback functions or nonstandard datatypes. You might also have access to existing C++ classes that perform the tasks you want to add to a PowerBuilder application, or you might want to create a wrapper for existing standard utilities written in C++.

For possible uses of PowerBuilder extensions, see [Understanding PowerBuilder extensions](#).

For examples of PowerBuilder extensions, see the PowerBuilder Code Samples Web site at <https://www.appeon.com/developers/library/code-samples-for-pb>.

2.2.2 Step 2: Define the classes and functions in the extension

Your C++ code must expose two standard methods that enable PowerBuilder to recognize each native class and create instances of the class. One of these methods is `PBX_GetDescription`.

Use `PBX_GetDescription` to pass the descriptions of classes and global functions in the PowerBuilder extension to PowerBuilder. Every extension must export this method. Importing the PBX or DLL file into a PBL converts the description of the extension into PowerScript and adds it to the PBL as source code. The keyword `native` in the source code indicates that the PowerBuilder type was defined in an extension.

All the classes or global functions in an extension module are passed in a single description. The examples that follow illustrate how you define classes and functions in a description. For the full syntax, see [PBX_GetDescription](#).

Describing nonvisual classes

Nonvisual classes can inherit from the `NonVisualObject` PowerBuilder system class or any of its descendants. While a native class can inherit from a user-defined user object,

Appeon recommends that you use only system classes. Each native class can provide several functions, subroutines, and events.

The following example shows how you use the `PBX_GetDescription` method in the C++ code for an extension that includes three nonvisual classes. `ClassName1` inherits from `NonVisualObject`, `ClassName2` inherits from `Exception`, and `ClassName3` inherits from `Transaction`. All three classes must be in a single description passed by `PBX_GetDescription`:

```
PBXEXPORT LPCTSTR PBXCALL PBX_GetDescription()
{
    static const TCHAR desc[] = {
        // Description begins here
        "class ClassName1 from NonVisualObject\n"
        "function integer objectFunction(integer a[])\n"
        "subroutine objectSubroutine(integer ai_ref)\n"
        "event integer eventName(integer b)\n"
        "end class\n"

        "class ClassName2 from Exception\n"
        "function integer objectFunction(readonly
            integer ai)\n"
        "subroutine objectSubroutine(integer arg)\n"
        "event integer eventName(integer arg)\n"
        "end class\n"

        "class ClassName3 from Transaction\n"
        "function integer objectFunction(integer arg)\n"
        "subroutine objectSubroutine(integer arg)\n"
        "event integer eventName(integer arg)\n"
        "end class\n"
        // Description ends here
    };
    return desc;
}
```

Describing visual classes

Visual native classes can inherit only from the `UserObject` PowerBuilder system class. The PowerBuilder VM considers any class that inherits from `UserObject` to be a visual class. All other native classes are considered to be nonvisual classes. For more information about how to describe visual classes, see [Creating and using a visual extension](#).

Describing global functions

An extension can include global functions as well as classes. This example shows a description for two global functions:

```
"globalfunctions \n" \
"function int g_1(int a, int b)\n" \
"function long g_2(long a, long b)\n" \
"end globalfunctions\n"
```

The syntax and usage of global functions defined in an extension are the same as for global functions defined in the Function painter in PowerBuilder.

Global functions cannot be overloaded

Like global functions in PowerScript, global functions in a PowerBuilder extension cannot be overloaded.

Using forward declarations

PowerBuilder extensions can provide multiple classes. A class can reference any class that is defined earlier in the description, but if it references a class defined later in the description, you must provide a forward declaration. This example shows a description that includes forward declarations for two classes, `nativeclass_1` and `nativeclass_2`, that reference each other. This example also demonstrates that a single description can include global functions as well as classes:

```
"forward\n" \
"class nativeclass_1 from nonvisualobject\n"\
"class nativeclass_2 from nonvisualobject\n"\
"end forward\n" \

"class nativeclass_1 from nonvisualobject\n" \
"function int add(nativeclass_2 a, int b)\n" \
"function int sub(int a, int b)\n" \
"end class\n" \

"class nativeclass_2 from nonvisualobject\n" \
"function int add(nativeclass_1 a, int b)\n" \
"function int sub(int a, int b)\n" \
"end class\n"

"globalfunctions\n" \
"function int g_1(int a, int b)\n" \
"function long g_2(long a, long b)\n" \
"end globalfunctions\n"
```

2.2.3 Step 3: Declare native classes and global functions

For each native class that the nonvisual extension supports, declare an ANSI C++ class that inherits from `IPBX_NonVisualObject`, which is the ancestor class for all nonvisual PowerBuilder native classes.

The declaration of the class can be placed in a header file, and it must include `Invoke` and `Destroy` methods. This is a simple prototype for a nonvisual class:

```
#include "pbext.h"

class CMyClass : public IPBX_NonVisualObject
{
enum MethodIDs
{
    mFunca = 0,
    mFuncb = 1
};
public:
    // constructor, destructor
    CMyClass()
    virtual ~CMyClass()
    // member methods    PBXRESULT Invoke(
        IPB_Session    *session,
        pbobject    obj,
        pbmethodID    mid,
        PBCallInfo    *ci
    );
    void Destroy();

private:
    void funcA(IPB_Session* session, pbobject obj,
```

```

    PBCallInfo* ci);
void funcB(IPB_Session* session, pobject obj,
    PBCallInfo* ci);
};

```

If you declare global functions in your extension, the extension must export the `PBX_InvokeGlobalFunction` method. The following `PBX_GetDescription` call declares three global functions: `bitAnd`, `bitOr`, and `bitXor`:

```

PBXEXPORT LPCTSTR PBXCALL PBX_GetDescription()
{
    static const TCHAR desc[] = {
        "globalfunctions\n"
        "function int bitAnd(int a, int b)\n"
        "function int bitOr(int a, int b)\n"
        "function int bitXor(int a, int b)\n"
        "end globalfunctions\n"
    };

    return desc;
}

```

2.2.4 Step 4: Implement native classes and global functions

The implementation of each class must include the implementation of the `Invoke` and `Destroy` methods, as well as all the methods declared for the class. `Invoke` and `Destroy` are methods of the `IPBX_UserObject` interface.

When the PowerBuilder application calls a method on the native class, the PBVM calls the `Invoke` method, which dispatches the call based on the method ID or method name. The method name is used when the method is called dynamically.

The `Invoke` method must be coded to invoke each method in the class. The example that follows shows a switch-case statement that invokes either `funcA` or `funcB`, depending on the value of the method ID. When the PowerBuilder application has finished using an instance of a native class, the PBVM calls the `Destroy` method.

This example does not show the implementation of the methods of the class itself:

```

PBXRESULT MyClass::Invoke(IPB_Session *session, pobject obj, pbmethodID mid,
    PBCallInfo *ci)
{
    PBXRESULT result = PBX_OK;

    switch (mid)
    {
        case mFuncA:
            result = funcA(session, obj, ci);
            break;

        case mFuncB:
            result = funcB(session, obj, ci);
            break;

        default:
            result = PBX_E_INVOKE_FAILURE;
            break;
    }

    return result;
}

```

```
// Implementation of funcA and funcB not shown
void Destroy()
{
    delete this;
}
```

The following PBX_InvokeGlobalFunction contains the implementation of the three global functions included in the description shown in [Step 3: Declare native classes and global functions](#):

```
PBXEXPORT PBXRESULT PBXCALL PBX_InvokeGlobalFunction
(
    IPB_Session*    pbsession,
    LPCTSTR         functionName,
    PBCallInfo*    ci    )
{
    PBXRESULT pbrResult = PBX_OK;

    int arg1 = ci->pArgs->GetAt(0)->GetInt();
    int arg2 = ci->pArgs->GetAt(1)->GetInt();

    if (strcmp(functionName, "bitand") == 0)
    {
        ci->returnValue->SetInt(arg1 & arg2);
    }else if (strcmp(functionName, "bitor") == 0)
    {
        ci->returnValue->SetInt(arg1 | arg2);
    }else if (strcmp(functionName, "bitxor") == 0)
    {
        ci->returnValue->SetInt(arg1 ^ arg2);
    }else
    {
        return PBX_FAIL;
    }

    return pbrResult;
}
```

2.2.5 Step 5: Export methods to create class instances

PowerBuilder creates nonvisual and visual class instances differently:

- For visual classes, the instance is created when the window or visual control in which the class is used is opened. See [Creating visual class instances](#).
- For nonvisual classes, the instance is created when the PowerBuilder CREATE statement is used. This is described next.

When the PowerBuilder application creates an instance of a nonvisual class using the PowerScript CREATE statement, the PBVM calls the PBX_CreateNonVisualObject method in the extension. Every extension that contains nonvisual native classes must export this method.

In the same way that multiple classes are included in a single description passed by PBX_GetDescription, PBX_CreateNonVisualObject can be used to create multiple classes.

In this example, the extension has three classes. An IF statement compares the name of the class passed in from the PowerBuilder CREATE statement to the name of each of the classes

in the extension in turn and creates an instance of the first class with a matching name. You could also use a CASE statement. The class name in the string comparison must be all lowercase:

```
PBXEXPORT PBXRESULT PBXCALL PBX_CreateNonVisualObject(
    IPB_Session * session,
    pbject obj,
    LPCSTR className,
    IPBX_NonVisualObject **nvobj
)
{
    PBXRESULT result = PBX_OK;
    // The class name must not contain uppercase
    if ( strcmp( className, "classone" ) == 0 )
        *nvobj = new ClassOne;
    else if ( strcmp( className, "classtwo" ) == 0 )
        *nvobj = new ClassTwo( session );
    else if ( strcmp( className, "classthree" ) == 0 )
        *nvobj = new ClassThree;
    else {
        *nvobj = NULL;
        result = PBX_E_NO_SUCH_CLASS;
    }
    return PBX_OK;
};
```

2.2.6 Step 6: Build a PBX

Using your C++ development tool or the command line, build a PBX from your C++ classes.

When you compile and link the C++ code, verify the following:

- The include directory for the PBNI SDK, typically PowerBuilder 17.0\SDK\PBNI\include, must be in your include path.
- If you use any helper classes, make sure the source file that contains them is added to your project. For a list of classes, see the table in [The PBNI SDK](#).

Now you are ready to use the extension in a PowerBuilder application.

2.3 Adding an extension to a PowerBuilder target

The simplest way to add a PowerBuilder native class to a PowerBuilder target is to import the object descriptions in the PBX file into a library in the PowerBuilder System Tree. You can also use a command-line tool to create a PBD file from a PBX file and add it to the target's library search path. See [pbx2pbd170](#).

To import the descriptions in an extension into a library:

1. Copy the PBX file into a directory on the application's path.
2. In the System Tree, expand the target in which you want to use the extension, right-click a library, and select Import PB Extension from the pop-up menu.

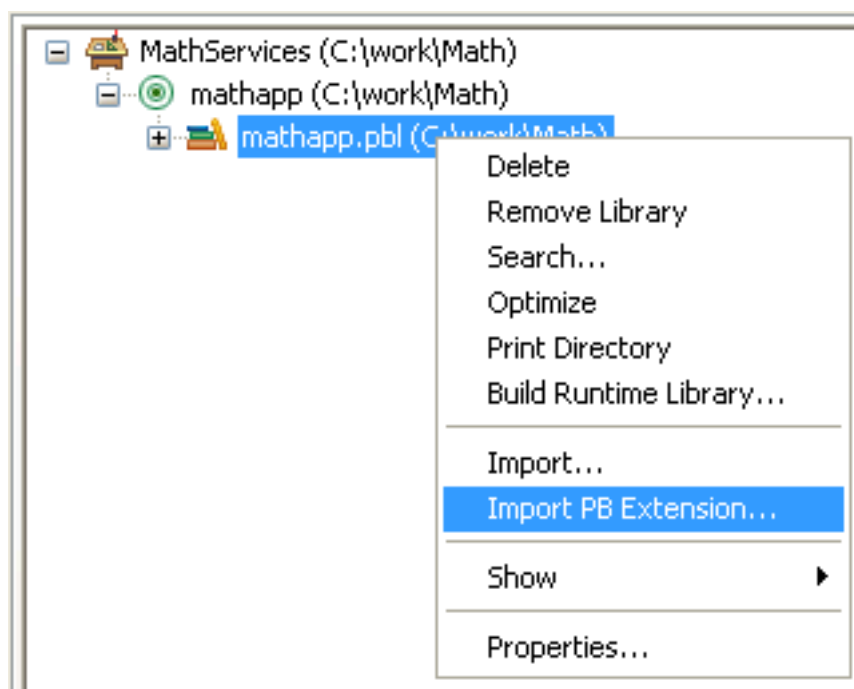

3. Navigate to the location of the PBX file and click Open.

Each class in the PBX displays in the System Tree so that you can expand it, view its properties, events, and methods, and drag and drop to add them to your scripts.

2.4 Using the extension

Using nonvisual classes

In PowerScript, use the classes in a nonvisual extension just as you would a custom class user object: Declare an instance of the object, use the CREATE statement to create the instance, invoke the object's functions, and destroy the instance when you have finished with it. You can inherit from the native classes if you want to add functions or events to the class.

At runtime, instances of the native class are created as normal PowerBuilder objects.

In this example, the extension module contains two nonvisual native classes: fontcallback and fontenumerator. A PowerBuilder custom class user object, nvo_font, inherits from the fontcallback class. These statements create instances of both classes:

```
fontenumerator fe
nvo_font uf
fe = create fontenumerator
uf = create nvo_font
```

After an instance of a native class has been created, the PowerBuilder application can call methods on the object. Each native class must implement an Invoke method that the PowerBuilder VM calls when the PowerBuilder application calls one of the native class's methods. Then, the Invoke method dispatches the method call based on the method ID or method name. The method name is used when a native method is called dynamically.

Using the previous example, this statement invokes the enumprinterfonts method of the instance of the fontenumerator class:

```
fe.enumprinterfonts(uf)
```

Destroying the PBNI object instance

When the PowerBuilder application no longer needs an instance of a nonvisual class and a DESTROY statement is issued, by either the user or the garbage collector, or when the window or visual control that contains a visual class is closed, the PowerBuilder VM destroys the instance by calling the native class's Destroy method.

2.5 Creating and using a visual extension

In general, you follow the same steps to create and use a visual extension that you do to create a nonvisual extension:

[Step 1: Decide on a feature to implement.](#)

[Step 2: Define the classes and functions in the extension.](#)

[Step 3: Declare visual classes and global functions.](#)

[Step 4: Implement native classes.](#)

[Step 5: Export methods to create class instances.](#)

[Step 6: Build and use a PBX.](#)

[Step 7: Use the visual extension in an application.](#)

Using PowerBuilder visual objects in C++

For information about using PowerBuilder visual objects from a C++ application, see [Processing PowerBuilder messages in C++](#).

2.5.1 Step 1: Decide on a feature to implement

You can choose to use visual extensions to implement controls with a specific purpose or that use a custom look and feel. For some examples of visual extensions, see the PowerBuilder Code Samples Web site at <https://www.appeon.com/developers/library/code-samples-for-pb>.

2.5.2 Step 2: Define the classes and functions in the extension

The description for a visual class follows the same rules as for a nonvisual class, but it must inherit from the UserObject system class:

```
PBXEXPORT LPCTSTR PBXCALL PBX_GetDescription()
{
    static const TCHAR desc[] = {
        "class myvisualext from userobject\n"
        "subroutine func_1(int arg1, int arg2)\n"
        "subroutine func_2(string arga)\n"
        "end class\n"
    };
    return desc;
}
```

There are no events in the preceding example, but a typical visual extension makes use of events such as mouse clicks. There are two ways to declare and handle events. See [Event processing in visual extensions](#).

2.5.3 Step 3: Declare visual classes and global functions

You declare native visual classes in the same way as nonvisual classes, except that you declare an ANSI C++ class that inherits from `IPBX_VisualObject`, which is the ancestor class for all nonvisual PowerBuilder native classes, instead of from `IPBX_NonVisualObject`. You can also declare global functions in a visual extension. See [Step 3: Declare native classes and global functions](#) in the section on nonvisual extensions.

2.5.4 Step 4: Implement native classes

You implement `Invoke` and `Destroy` methods and any class or global functions the same way for visual extensions as for nonvisual extensions. See [Step 4: Implement native classes and global functions](#).

2.5.5 Step 5: Export methods to create class instances

The major difference between visual and nonvisual extensions is in how instances of the class are created. See [Creating visual class instances](#).

2.5.6 Step 6: Build and use a PBX

As for nonvisual extensions, you must build a PBX, import it into the application, and put the PBX in the execution path. See [Step 6: Build a PBX](#) and [Adding an extension to a PowerBuilder target](#) in the section on nonvisual extensions.

2.5.7 Step 7: Use the visual extension in an application

You do not need to declare an instance of a visual class or use the `CREATE` statement to create an instance. The PBVM creates an instance when the window or visual control in which the visual class resides is opened, as described in [Creating visual class instances](#). You can invoke the object's functions the same way that you invoke a nonvisual object's functions.

To use a visual extension:

1. Select `File>Inherit` from the PowerBuilder menu and select the PBD in the Libraries list in the `Inherit from Object` dialog box.
2. Select the visual class and click `OK`.
3. In the User Object painter, size the visual object and make any other changes you need.
4. Save the object.

You can now drag the new user object from the System Tree directly onto a window or onto another visual control, such as a tab control, and use it like any other visual user object.

Code samples

The code fragments in the rest of this section are based on complete sample applications that you can find on the PowerBuilder Code Samples Web site at <https://www.appeon.com/developers/library/code-samples-for-pb>.

2.6 Creating visual class instances

When the window or other visual control in which a visual native class resides is created in a PowerBuilder application, the PBVM calls the PBX_CreateVisualObject method in the extension automatically -- the PowerBuilder application developer does not need to write a CREATE statement in a script. The PBVM also calls the IPBX_VisualObject's CreateControl method. Every extension that contains visual native classes must export PBX_CreateVisualObject and implement CreateControl.

The following is sample code for PBX_CreateVisualObject:

```
PBXEXPORT PBXRESULT PBXCALL PBX_CreateVisualObject
(
    IPB_Session*      pbsession,
    pbobject          pbobj,
    LPCTSTR           className,
    IPBX_VisualObject **obj
)
{
    PBXRESULT result = PBX_OK;

    string cn(className);
    if (cn.compare("visualext") == 0)
    {
        *obj = new CVisualExt(pbsession, pbobj);
    }
    else
    {
        *obj = NULL;
        result = PBX_FAIL;
    }

    return PBX_OK;
};
```

Registering the window class

Before CreateControl can be called, the window class must be registered. This code uses the Windows RegisterClass method to register the window class with the class name s_className:

```
void CVisualExt::RegisterClass()
{
    WNDCLASS wndclass;

    wndclass.style = CS_GLOBALCLASS | CS_DBLCLKS;
    wndclass.lpfWndProc = WindowProc;
    wndclass.cbClsExtra = 0;
    wndclass.cbWndExtra = 0;
    wndclass.hInstance = g_dll_hModule;
    wndclass.hIcon = NULL;
    wndclass.hCursor = LoadCursor (NULL, IDC_ARROW);
    wndclass.hbrBackground = (HBRUSH) (COLOR_WINDOW + 1);
    wndclass.lpszMenuName = NULL;
    wndclass.lpszClassName = s_className;

    ::RegisterClass (&wndclass);
}
```

You must also implement the Windows UnregisterClass method to unregister the class when the window is closed:

```
void CVisualExt::UnregisterClass()
{
    ::UnregisterClass(s_className, g_dll_hModule);
}
```

The RegisterClass and UnregisterClass methods are called in the initialization code for the PBX. This is the Visual C++ DllMain method:

```
BOOL APIENTRY DllMain( HANDLE hModule,
                      DWORD  reasonForCall,
                      LPVOID lpReserved
                      )
{
    g_dll_hModule = (HMODULE)hModule;

    switch (reasonForCall)
    {
        case DLL_PROCESS_ATTACH:
            CVisualExt::RegisterClass();
            break;

        case DLL_THREAD_ATTACH:
        case DLL_THREAD_DETACH:
            break;

        case DLL_PROCESS_DETACH:
            CVisualExt::UnregisterClass();
            break;
    }
    return TRUE;
}
```

Implementing CreateControl

Every visual native class must implement the IPBX_VisualObject CreateControl method. After getting the class name with the IPBX_VisualObject GetClassName method, CreateControl passes the class name to the Windows CreateWindowEx method to create the window, then returns the window handle to the PBVM:

```
TCHAR CVisualExt::s_className[] = "PBVisualExt";

LPCTSTR CVisualExt::GetWindowClassName()
{
    return s_className;
}

HWND CVisualExt::CreateControl
(
    DWORD dwExStyle,          // extended window style
    LPCTSTR lpWindowName,    // window name
    DWORD dwStyle,           // window style
    int x,                   // horizontal position of window
    int y,                   // vertical position of window
    int nWidth,              // window width
    int nHeight,             // window height
    HWND hWndParent,         // handle to parent or
                            // owner window
    HINSTANCE hInstance      // handle to application
                            // instance
)
{
    d_hwnd = CreateWindowEx(dwExStyle, s_className,
        lpWindowName, dwStyle, x, y, nWidth, nHeight,
```

```

    hWndParent, NULL, hInstance, NULL);

    ::SetWindowLong(d_hwnd, GWL_USERDATA, (LONG)this);
    return d_hwnd;
}

```

2.7 Event processing in visual extensions

A visual extension can have a window procedure that can process any Windows message or user-defined message. The PBVM passes all such messages to the visual extension, which can intercept messages and either process or ignore them.

WindowProc is an application-defined callback function that processes messages sent to a window. In the example in this section, a WM_PAINT message is sent to the extension when an action in the PowerBuilder application causes the window to be redrawn. When the extension receives the message, it repaints an area in the window using the current values for text and color set by the user of the application.

The following example also captures mouse clicks and double clicks, and triggers the Onclick and Ondoubleclick event scripts in the PowerBuilder application. You can use two different syntaxes for describing events:

```

event returnType eventName(args_desc) newline
event eventName pbevent_token newline

```

2.7.1 Using an event name with return type and arguments

The following description uses the first syntax. The class has two events, onclick and ondoubleclick:

```

PBXEXPORT LPCTSTR PBXCALL PBX_GetDescription()
{
    static const TCHAR desc[] = {
        "class visualext from userobject\n"
        "event int onclick()\n"
        "event int ondoubleclick()\n"
        "subroutine setcolor(int r, int g, int b)\n"
        "subroutine setttext(string txt)\n"
        "end class\n"
    };
    return desc;
}

```

Capturing messages and mouse clicks

The code in the extension captures the Windows messages that cause the window to be drawn, as well as mouse clicks and double clicks:

```

LRESULT CALLBACK CVisualExt::WindowProc(
    HWND hwnd,
    UINT uMsg,
    WPARAM wParam,
    LPARAM lParam
)
{
    CVisualExt* ext = (CVisualExt*)::GetWindowLong(hwnd,
        GWL_USERDATA);
    switch(uMsg) {

```

```

case WM_CREATE:
    return 0;

case WM_SIZE:
    return 0;

case WM_COMMAND:
    return 0;

case WM_PAINT: {
    PAINTSTRUCT ps;
    HDC hdc = BeginPaint(hwnd, &ps);
    RECT rc;
    GetClientRect(hwnd, &rc);
    LOGBRUSH lb;
    lb.lbStyle = BS_SOLID;

// Get color using the visual class's GetColor method
    lb.lbColor = ext->GetColor();
    HBRUSH hbrush = CreateBrushIndirect(&lb);
    HBRUSH hbrOld = (HBRUSH)SelectObject(hdc,
        hbrush);
    Rectangle(hdc, rc.left, rc.top, rc.right-rc.left,
        rc.bottom-rc.top);
    SelectObject(hdc, hbrOld);
    DeleteObject(hbrush);

// Get text using the visual class's GetText method
    DrawText(hdc, ext->GetText(),
        ext->GetTextLength(), &rc,
        DT_CENTER|DT_VCENTER|DT_SINGLELINE);
    EndPaint(hwnd, &ps);
}
return 0;

// Trigger event scripts in the PowerBuilder application
case WM_LBUTTONDOWN:
    ext->TriggerEvent("onclick");
    break;

case WM_LBUTTONDBLCLK:
    ext->TriggerEvent("ondoubleclick");
    break;
}
return DefWindowProc(hwnd, uMsg, wParam, lParam);
}

```

Triggering click events

The following is the TriggerEvent method that triggers the Onclick and Ondoubleclick events:

```

void CVisualExt::TriggerEvent(LPCTSTR eventName)
{
    pbclass clz = d_session->GetClass(d_pboobj);
    pbmethodID mid = d_session->GetMethodID(clz,
        eventName, PBRT_EVENT, "I");

    PBCallInfo ci;
    d_session->InitCallInfo(clz, mid, &ci);
    d_session->TriggerEvent(d_pboobj, mid, &ci);
    d_session->FreeCallInfo(&ci);
}

```

2.7.2 Using an event name with a PowerBuilder event ID

A simpler way to trigger events in a visual extension uses direct mapping of Windows messages to PowerBuilder events. The following class description contains the same two events, but in this case they use the alternative syntax that maps the event name to a PowerBuilder token name:

```
PBXEXPORT LPCTSTR PBXCALL PBX_GetDescription()
{
    static const TCHAR desc[] = {
        "class visualext from userobject\n"
        "event onclick pbm_lbuttonup\n"
        "event ondoubleclick pbm_lbuttondblclk\n"
        "subroutine setcolor(int r, int g, int b)\n"
        "subroutine settext(string txt)\n"
        "end class\n"
    };
    return desc;
}
```

Generating event syntax automatically

Importing the extension generates the `OnClick` and `Ondoubleclick` events with the appropriate arguments automatically, and at runtime, the PBVM fires the events. You do not need to capture the Windows messages `WM_LBUTTONDOWN` and `WM_LBUTTONDBLCLK` in the extension.

In the following description, `onclick` is the event name and `pbm_lbuttonup` is the event token name. Notice that the event name is not followed by empty parentheses as it is when you use the return type and arguments technique for describing the event:

```
"event onclick pbm_lbuttonup\n"
```

About the token name

The token name is a string that maps to an internal PowerBuilder event ID defined in the header file `pbevtid.h`. The first ID in this file is `PB_NULL`. For all other IDs in the file, there is a fixed relationship between the name that you use in the description and the event ID in `pbevtid.h`. The name is the same as the ID with the letter `m` appended to the `pb` prefix. You must use lowercase in the description.

For example, the event ID `PB_ACTIVATE` in `pbevtid.h` maps to the token name `pbm_activate`. In the description provided with `PBX_GetDescription`, you must use the name `pbm_activate`. If the event name you provide does not exist, importing the extension generates an error message. See the `pbevtid.h` file for a complete list of mapped IDs.

2.7.3 Processing events sent to the parent of the window

Some Windows messages, such as `WM_COMMAND` and `WM_NOTIFY`, are sent to the parent of an object and not to the object itself. Such messages cannot be caught in the visual extension's window procedure. The PBVM calls the `GetEventID` method to process these messages, as follows:

- If the message is mapped to a PowerBuilder event, `GetEventID` returns the event's identifier, for example `PB_BNCLICKED`, and the event is fired automatically.
- If the message is not mapped to an event, `GetEventID` returns the value `PB_NULL` and the message is discarded.

In the following example, the `GetEventID` function returns the identifier `PB_BNCLICKED` if a `WM_COMMAND` message with the notification code `BN_CLICKED` was sent. It returns the identifier `PB_ENCHANGE` if a `WM_NOTIFY` message was sent. Otherwise, it returns `PB_NULL`.

```
TCHAR CVisualExt::s_className[] = "PBVisualExt";

LPCTSTR CVisualExt::GetWindowClassName()
{
    return s_className;
}

HWND CVisualExt::CreateControl
(
    DWORD dwExStyle,          // extended window style
    LPCTSTR lpWindowName,    // window name
    DWORD dwStyle,           // window style
    int x,                    // horizontal position of window
    int y,                    // vertical position of window
    int nWidth,              // window width
    int nHeight,             // window height
    HWND hWndParent,         // handle of parent or owner window
    HINSTANCE hInstance      // handle of application instance
)
{
    d_hwnd = CreateWindowEx(dwExStyle, s_className,
        lpWindowName, dwStyle, x, y, nWidth, nHeight,
        hWndParent, NULL, hInstance, NULL);

    ::SetWindowLong(d_hwnd, GWL_USERDATA, (LONG)this);

    return d_hwnd;
}

int CVisualExt::GetEventID(
    HWND hWnd,               /* Handle of parent window */
    UINT iMsg,               /* Message sent to parent window*/
    WPARAM wParam,           /* Word parameter of message*/
    LPARAM lParam            /* Long parameter of message*/
)
{
    if (iMsg == WM_COMMAND)
    {
        if ((HWND)lParam == d_hwnd)
        {
            switch(HIWORD(wParam))
            {
                case BN_CLICKED:
                    return PB_BNCLICKED;
                    break;
            }
        }
    }

    if (iMsg == WM_NOTIFY)
    {
        return PB_ENCHANGE;
    }

    return PB_NULL;
}
```

2.8 Calling PowerScript from an extension

You can call PowerBuilder system functions through `IPB_Session`. The `InitCallInfo` method simplifies the process of setting up the call information. You need to provide the arguments to the `InitCallInfo` method, including an identifier for the PowerBuilder function you want to call.

The identifier can be returned from the `GetMethodID` or `FindMatchingFunction` method.

Using `GetMethodID`

To get the function's ID using the `GetMethodID` method, you need the function's signature:

```
PbmethodID GetMethodID(pbclass cls, LPCTSTR  
    methodName, PBRoutineType rt, LPCTSTR signature);
```

The signature argument in this method call is a string representing the method's return type and arguments. You can obtain this string in the Browser.

For example, to obtain the signature of a system function, select systemfunctions from the left pane of the System page, right-click the function in the right pane, and select Properties from its pop-up menu:

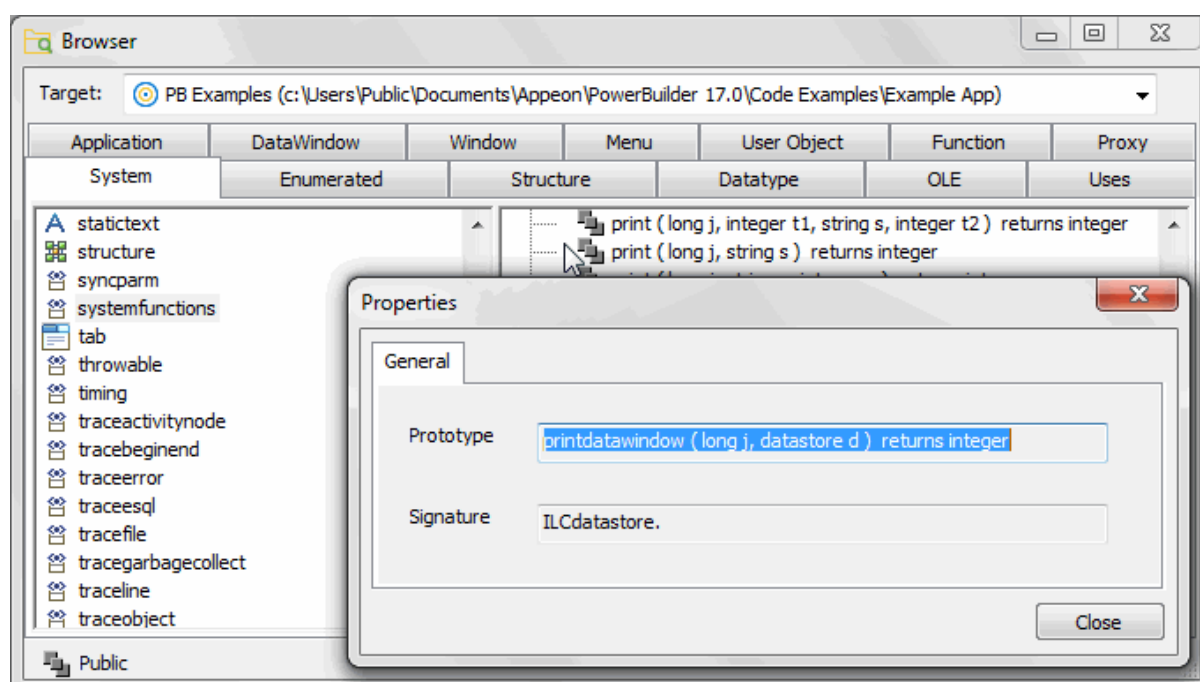

For methods in your application, you can expand the object that contains it in the System Tree, select the function or event, and select Properties from its pop-up menu:

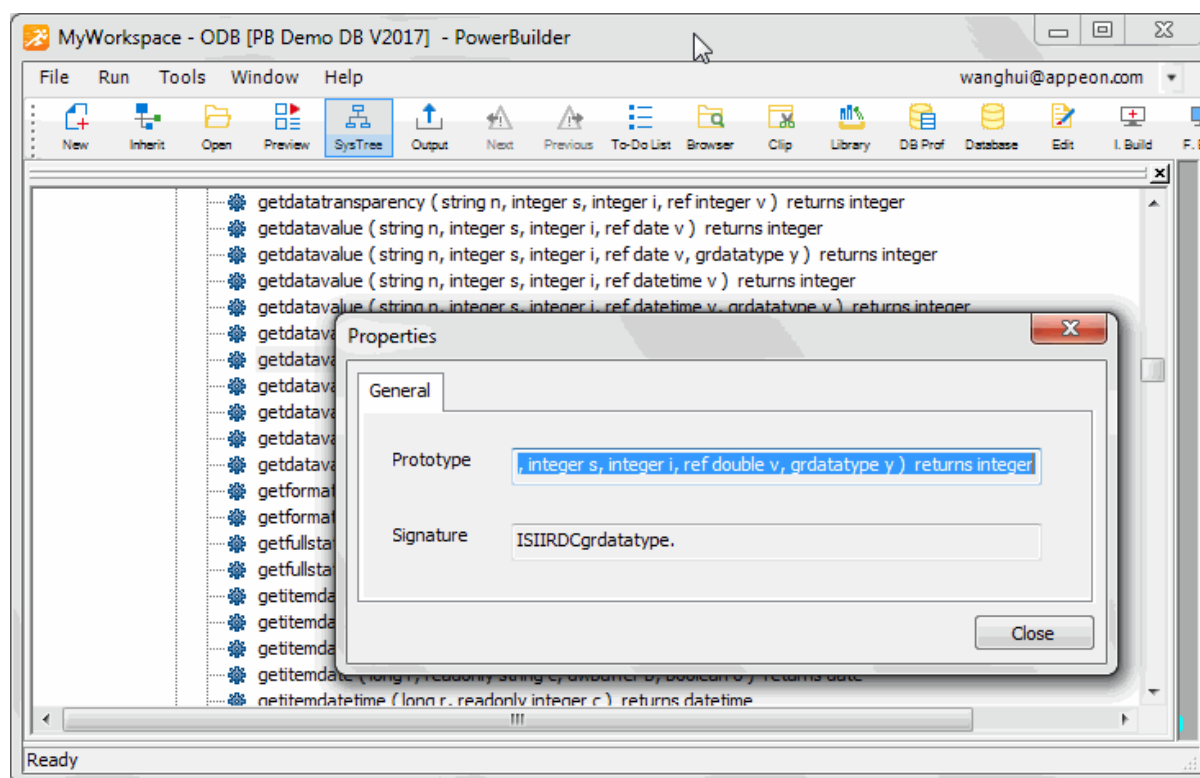

Consider this function:

```
of_get_trans ( ref transaction atr_trans ) returns (none)
```

The signature for this function is QRCtransaction. Q indicates that the function does not return a value, R that the argument is passed by reference, and Ctransaction that the argument is a PowerBuilder system object of type transaction.

You can use the pbsig170 command-line tool to obtain a function's signature. However, the pbsig170 tool does not report the signature of functions that are inherited from an ancestor object unless they are extended in the descendant, and it does not report event signatures.

For more information about using pbsig170, and an explanation of all the formats used in the signature, see [pbsig170](#).

Using FindMatchingFunction

Instead of the string that GetMethodID uses, the FindMatchingFunction function provides another way to get the method ID. Some short signatures can be difficult to parse, and signatures that include PowerBuilder system objects or Java classes can be much longer.

FindMatchingFunction uses a "readable signature" instead of the string used by GetMethodID:

```
FindMatchingFunction(pbclass cls, LPCTSTR methodName, PBRoutineType rt, LPCTSTR readableSignature)
```

The readableSignature argument is a comma-separated list of the arguments of the function. Unlike the string used by GetMethodID, it does not include the return type. For example, for a function called uf_test that takes two arguments, an int by value and a double by reference, the call to FindMatchingFunction looks like this:

```
mid = Session -> FindMatchingFunction(cls, "uf_test",
```

```
PBRT_FUNCTION, "int, double");
```

Invoking PowerBuilder functions

The following methods are those you use most frequently to invoke PowerBuilder functions. For descriptions of each method, see [IPB_Session interface](#).

```
PbmethodID GetMethodID(pbclass cls, LPCTSTR methodName,
    PBRoutineType rt, LPCTSTR signature, pbboolean publiconly)
PBXRESULT InitCallInfo(pbclass cls, pbmethodID mid, PBCallInfo *ci)
void FreeCallInfo(PBCallInfo *ci)
PBXRESULT Add<Type>Argument(PBCallInfo *ci, PBType v);
PBXRESULT InvokeClassFunction(pbclass cls, pbmethodID mid, PBCallInfo *ci)
PBXRESULT InvokeObjectFunction(pbobject obj, pbmethodID mid, PBCallInfo *ci)
PBXRESULT TriggerEvent(pbobject obj, pbmethodID mid, PBCallInfo *ci)
```

2.8.1 Example: Calling PowerBuilder functions

In this code fragment, the class and method ID returned by calls to the `IPB_Session` `GetClass` and `GetMethodID` methods are used to initialize a `PBCallInfo` structure, called `ci`, using the `IPB_Session` `InitCallInfo` method.

After a new `pbstring` variable is created, the value of that string is set to the value of the first argument in the `PBCallInfo` structure.

```
BOOL CALLBACK CFontEnumerator::EnumFontProc
(
    LPLOGFONT lplf,
    LPNEWTEXTMETRIC lpntm,
    DWORD FontType,
    LPVOID userData
)
{
    UserData* ud = (UserData*)userData;
    pbclass clz = ud->session->GetClass(ud->object);
    pbmethodID mid = ud->session->GetMethodID
        (clz, "onnewfont", PBRT_EVENT, "IS");

    PBCallInfo ci;
    ud->session->InitCallInfo(clz, mid, &ci);

    // create a new string variable and set its value
    // to the value in the first argument in the
    // PBCallInfo structure
    pbstring str = ud->session->NewString
        (lplf->lfFaceName);
    ci.pArgs->GetAt(0)->SetString(str);

    ud->session->TriggerEvent(ud->object, mid, &ci);
    pbint ret = ci.returnValue->GetInt();

    ud->session->FreeCallInfo(&ci);
    return ret == 1 ? TRUE : FALSE;
}
```

2.9 Exception handling and debugging

To handle errors, you use the error codes returned from PBNI methods. Some functions of the `IPB_Session` interface return detailed error codes that make debugging easier.

Native methods, such as the `IPBX_UserObject` `Invoke` method, return either `PBX_OK` or `PBX_FAIL` if the extension encounters a serious problem from which it cannot recover.

Whenever the PowerBuilder VM gets PBX_FAIL from a native method, it throws a PBXRuntimeError in the PowerBuilder application. PBXRuntimeError inherits from the PowerBuilder RuntimeError system object and can be caught and handled in a script in the same way as any exception in PowerBuilder.

To catch these errors, wrap your PowerScript call in a try-catch block as follows:

```
TRY
  n_cpp_pbniobj  obj
  obj = CREATE n_cpp_pbniobj
  obj.of_test( arg1 )
CATCH ( PBXRuntimeError re )
  MessageBox( "Caught error", re.getMessage() )
END TRY
```

The IPB_Session interface provides a set of methods to handle exceptions that occur in native code. Use [HasExceptionThrown](#) to determine whether an exception occurred. If it did, use [GetException](#) to get the current exception object so that it can be handled. If necessary, you can throw exceptions to PowerBuilder with [ThrowException](#). When an exception has been handled, use [ClearException](#) to clear it.

Debugging

You cannot edit a native class in the PowerBuilder development environment, and you cannot enter native methods in the PowerBuilder debugger because the methods are C++ methods. You must use a C/C++ debugger to debug an extension module.

3 Creating Marshaler Extensions

About this chapter

This chapter describes how to create marshaler extensions.

3.1 About marshaler extensions

Marshaler extensions can act as bridges between PowerBuilder and other components, such as EJB components, Java classes, and Web services, as long as those components can be called from C++.

To create a marshaler extension, build a PBX that contains at least one class that implements the `IPBX_Marshaler` interface, as well as one or more native classes. The extension must contain code that associates the marshaler with a proxy for the component you want to call.

If you build a marshaler extension, you should also provide a tool that generates proxies so the components can be called from PowerBuilder. For example, PowerBuilder provides a marshaler extension for calling EJB components from PowerBuilder, and it provides a tool for generating proxies for EJB components.

This chapter provides an overview based on the Java Marshaler sample application, which can be downloaded from the PowerBuilder Code Samples Web site at <https://www.appeon.com/developers/library/code-samples-for-pb>, and shows some extracts from the sample.

This chapter describes the major tasks involved in:

- [Developing the PowerBuilder extension](#)
- [Generating proxies for Java classes](#)
- [Calling the Java class from PowerBuilder](#)

This chapter does not show detailed code samples, and the fragments shown simplify the coding involved. For a more complete understanding of the process of building a marshaler extension, download the sample available on the Web site.

3.2 Developing the PowerBuilder extension

A PowerBuilder marshaler extension usually provides a native class that acts as a creator. This class defines a function that creates an instance of the foreign component that is specified in the parameters passed into the function (1). If it succeeds in creating an instance of the foreign component (2), it creates a proxy for it using the PBVM (3, 4), creates a marshaler object (5), and associates the marshaler with the proxy (6).

Figure: Creating a foreign component, proxy, and marshaler

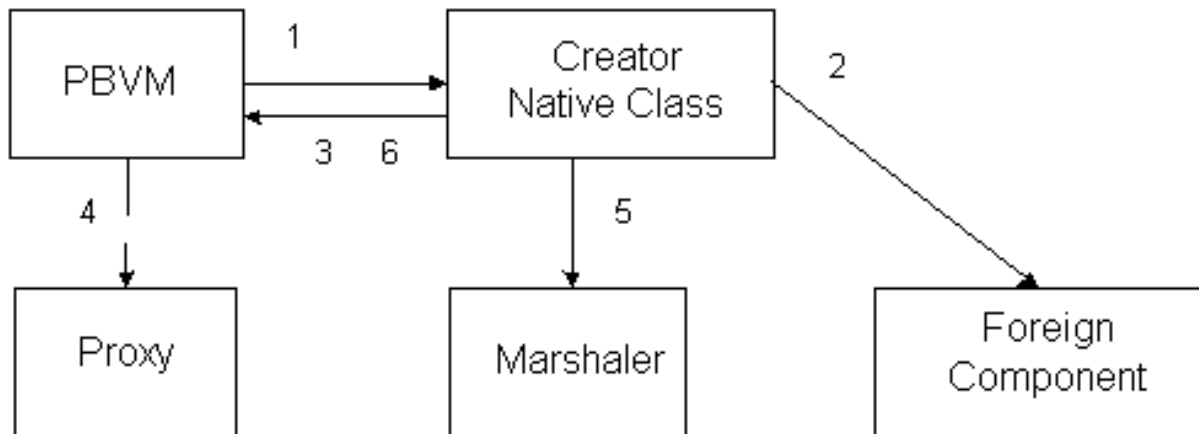

When a function of the proxy object is called in PowerScript, the PBVM calls the InvokeRemoteMethod function on the marshaler object through the proxy (1, 2). The marshaler object translates PowerBuilder function calls into requests that the foreign component understands, sends the requests (3), waits for a response, and send the results back to PowerBuilder (4).

Figure: Invoking a remote method

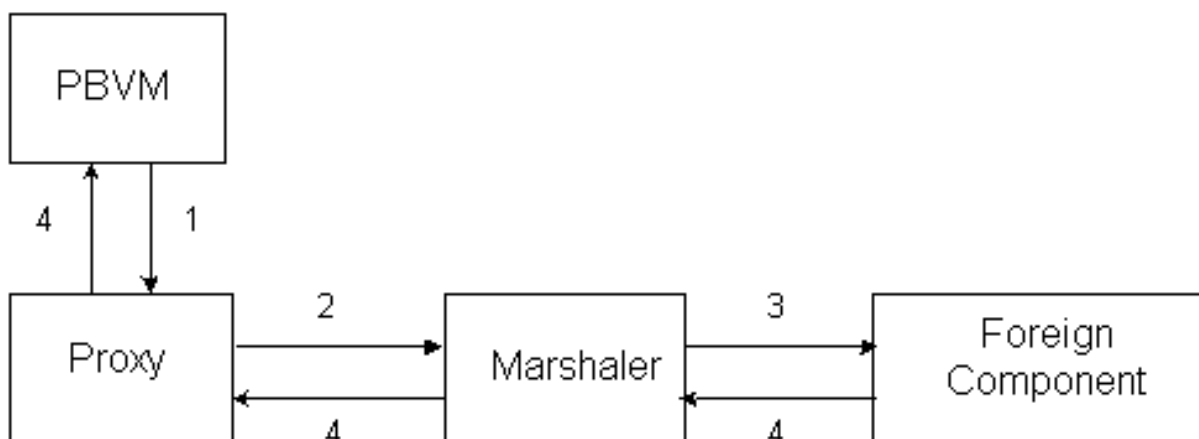

To develop the extension, you need to:

[Step 1: Describe the extension](#)

[Step 2: Implement the creator class](#)

[Step 3: Implement the marshaler class](#)

3.2.1 Step 1: Describe the extension

The class that implements the creator, called CJavaVM in the following example, must export the PBX_GetDescription function. It inherits from NonVisualObject and has two functions, CreateJavaObject and CreateJavaVM:

```
PBXEXPORT LPCTSTR PBXCALL PBX_GetDescription()
{
    static const TCHAR desc[] = {
        "class javavm from nonvisualobject\n"
        "function long createjavavm(string classpath,
            string properties[])\n"
        "function long createjavaobject(ref powerobject
```

```

        proxyobject, readonly string javaclassname,
        readonly string proxyname)\n"
    "end class\n"
};
return desc;
}

```

3.2.2 Step 2: Implement the creator class

Like any nonvisual native class, the CJavaVM class must implement the Invoke and Destroy functions in addition to the class functions CreateJavaObject and CreateJavaVM.

The CreateJavaVm function of CjavaVM gets the classpath and properties from the PBCallInfo structure. Then it loads the Java VM by calling the loadJavaVM function of a wrapper class called JavaVMWrapper. The JavaVMWrapper class encapsulates the JavaVM interface provided by JNI.

The CreateJavaObject function creates an instance of a Java class based on the given class name, creates a PowerBuilder proxy object for the Java object, creates a JavaMarshaler object, and associates the marshaler object with the proxy object.

The following is the CreateJavaObject function:

```

PBXRESULT CJavaVM::CreateJavaObject (
    IPB_Session *session,
    pbobject obj,
    PBCallInfo *ci )
{
    enum {
        kSuccessful = 0,
        kInvalidJavaClassName = -1,
        kFailedToCreateJavaClass = -2,
        kInvalidProxyName = -3,
        kFailToCreateProxy = -4 };

    // Get java class name.
    string jclassName;

    {
        pbstring jcn = ci->pArgs->GetAt(1)->GetPBString();
        if (jcn == NULL)
        {
            ci->returnValue->SetLong(kInvalidJavaClassName);
            return PBX_OK;
        }

        else {
            jclassName = session->GetString(jcn);
        }
    }

    // Create java object
    JavaVMWrapper* jvm = JavaVMWrapper::instance();
    JNIEnv* env = jvm->getEnv();

    jclass jcls = env->FindClass(jclassName.c_str());
    jobject jobj = NULL;

    if (jcls != NULL)
    {
        JLocalRef lrClz(env, jcls);
    }
}

```

```
jmethodID mid = env->GetMethodID(jcls, "<init>",
    "()V");
if (mid != NULL)
{
    jobj = env->NewObject(jcls, mid);
}
}

// Get PowerBuilder proxy name
string proxyName;

{
    pbstring pn = ci->pArgs->GetAt(2)->GetPBString();

    if (pn == NULL)
    {
        ci->returnValue->SetLong(kInvalidProxyName);
        return PBX_OK;
    }
    else
    {
        proxyName = session->GetString(pn);
    }
}

// Find proxy class
pbgroup group = session->FindGroup(proxyName.c_str(),
    pbgroup_proxy);
if (group == NULL)
{
    ci->returnValue->SetLong(kInvalidProxyName);
    return PBX_OK;
}

pbclass cls = session->FindClass(group, proxyName.c_str());
if (cls == NULL)
{
    ci->returnValue->SetLong(kInvalidProxyName);
    return PBX_OK;
}

// Create PowerBuilder proxy object.
pbproxyObject proxy = session->NewProxyObject(cls);
if (proxy == NULL)
{
    ci->returnValue->SetLong(kFailToCreateProxy);
    return PBX_OK;
}

// Create JavaMarshaler
JavaMarshaler* marshaler = new JavaMarshaler(env,
    proxy, jobj);

// Associate the JavaMarshaler with the proxy
session->SetMarshaler(proxy, marshaler);
ci->pArgs->GetAt(0)->SetObject(proxy);

ci->returnValue->SetLong(kSuccessful);
return PBX_OK;
}
```

3.2.3 Step 3: Implement the marshaler class

The marshaler class must implement the `InvokeRemoteMethod` function. It also needs to provide a `Destroy` function and get the handle of the module. This is the declaration:

```
#include <jni.h>
#include <pbext.h>

class JavaMarshaler : public IPBX_Marshaler
{
    jobject      d_jobject;
    pbproxyObject d_pbobject;

public:
    JavaMarshaler(JNIEnv* env, pbproxyObject pbobj, jobject ejbobj);
    ~JavaMarshaler();

    virtual PBXRESULT InvokeRemoteMethod (
        IPB_Session* session,
        pbproxyObject obj,
        LPCSTR      method_name,
        PBCallInfo* ci    );

    virtual pbulong GetModuleHandle();

    virtual void Destroy();
};
```

The `InvokeRemoteMethod` function calls Java functions through JNI. This is the implementation in `JavaMarshaler.cpp`:

```
#include "JavaMarshaler.h"
#include "JMethod.h"
#include "JavaVMWrapper.h"

extern pbulong g_dll_hModule;

pbulong JavaMarshaler::GetModuleHandle()
{
    return g_dll_hModule;
}

//*****
//  JavaMarshaler
//*****
JavaMarshaler::JavaMarshaler
(
    JNIEnv*      env,
    pbproxyObject pbobj,
    jobject      ejbobj
)
:   d_jobject(env->NewGlobalRef(ejbobj)),
    d_pbobject(pbobj)
{
}

JavaMarshaler::~JavaMarshaler()
{
    JNIEnv* env = JavaVMWrapper::instance()->getEnv();

    if (d_jobject != NULL && env != NULL)
        env->DeleteGlobalRef(d_jobject);
}
```

```

PBXRESULT JavaMarshaler::InvokeRemoteMethod
(
    IPB_Session*    session,
    pbproxyObject  obj,
    LPCSTR         szMethodDesc,
    PBCallInfo*    ci
)
{
    static char* eFailedToInvokeJavaMethod =
        "Failed to invoke the Java method.";

    JNIEnv* env = JavaVMWrapper::instance()->getEnv();
    JMethod method(this, szMethodDesc);

    try {
        if (d_jobject != NULL)
        {
            method.invoke(session, env, d_jobject, ci);
            if (env->ExceptionCheck() == JNI_TRUE)
            {
                string error(eFailedToInvokeJavaMethod);
                error += "\n";
                // Throw exception here

                return PBX_E_INVALID_ARGUMENT;
            }
        }
    }
    catch(...)
    {
    }

    return PBX_OK;
}

void JavaMarshaler::Destroy()
{
    delete this;
}

```

3.3 Generating proxies for Java classes

You need to develop PowerBuilder proxies for the Java classes you want to invoke from PowerBuilder. You can develop proxies using Java reflection, from Java source code directly, or using the javap tool. For example, suppose you want to invoke this Java class:

```

public class Converter
{
    public double dollarToYen(double dollar);
    public double yenToEuro(double yen);
}

```

The PowerBuilder proxy for this Java class could be stored in a file called converter.srx that looks like this:

```

$PBExportHeader$converter.srx
$PBExportComments$Proxy generated for Java class

global type Converter from nonvisualobject
end type
global Converter Converter

forward prototypes

```

```
public:
function double dollarToYen(double ad_1) alias
    for "dollarToYen,(D)D"
function double yenToEuro(double ad_1) alias
    for "yenToEuro,(D)D"
end prototypes
```

Notice that both PowerBuilder proxy methods have an alias containing the Java method name and method signature. This is necessary because Java is case sensitive, but PowerBuilder is not. The extension uses the alias information is used by the extension to find the corresponding Java methods.

To add the proxy to a PowerScript target, select the library where the proxy will be stored in the System Tree, select Import from the pop-up menu, and browse to select converter.srx.

3.4 Calling the Java class from PowerBuilder

In the open event of a window, create a Java VM:

```
// instance variable: javavm i_jvm
string properties[]
i_jvm = create javavm
string classpath
i_jvm.createjavavm(classpath, properties)
```

In the clicked event of a button on the window, create an instance of the Converter class using the CreateJavaObject method of the JavaVM instance, and call the conv method on the Converter class:

```
converter conv
double yen
i_jvm.createjavaobject(conv, "Converter", "converter")
yen = conv.dollarToYen(100.0)
messagebox("Yen", string(yen))
```

When the CreateJavaObject method is called in PowerScript, the PBVM calls the corresponding C++ method in the extension. The C++ method creates a Java Converter object through JNI. If it is successful, the method creates an instance of the PowerBuilder Converter proxy and a JavaMarshaler object, and associates the JavaMarshaler object with the PowerBuilder proxy.

When conv.dollarToYen(100.0) is called in PowerScript, the PowerBuilder VM calls the InvokeRemoteMethod method on the JavaMarshaler object, which delegates the call to the Java Converter object though JNI and returns the result to PowerBuilder.

4 Exchanging Data with PowerBuilder

About this chapter

This chapter describes how PBNI extensions exchange data with PowerBuilder.

4.1 About exchanging data with PowerBuilder

You can use the `IPB_Session` interface or the `IPB_Value` and `IPB_Arguments` interfaces to exchange data between PowerBuilder and PBNI. The `IPB_Session` interface contains many virtual functions that enable the C++ code in an extension to interact with the PBVM. The `IPB_Value` and `IPB_Arguments` interfaces contain methods that you can use to pass values between PowerBuilder and extensions.

4.2 Passing values between extensions and the PBVM

PBNI uses two interfaces, `IPB_Value` and `IPB_Arguments`, to pass PowerBuilder values between the PBVM and extension PBXs. The `PBNIInfo` structure holds the data.

4.2.1 PBCallInfo structure

The `PBCallInfo` structure is used to hold data and return type information for calls between extensions and the PBVM. It has three public members:

```
IPB_Arguments*  pArgs;
IPB_Value*      returnValue;
pbclass         returnClass;
```

The following code initializes a `PBCallInfo` structure using the `IPB_Session` `InitCallInfo` method. After allocating a `PBCallInfo` structure called `ci`, the `IPB_Session` `GetClass` and `GetMethodID` methods are used to get the class and method ID of the current method. Then, these parameters are used to initialize the `ci` structure:

```
pbclass cls;
pbmethodID mid;
PBCallInfo* ci = new PBCallInfo;

cls = Session -> GetClass(myobj);
mid = Session -> GetMethodID(cls, "myfunc",
    PBRT_FUNCTION, "II");

Session -> InitCallInfo(cls, mid, ci);
```

When you have finished using a `PBCallInfo` structure, you must call `FreeCallInfo` to release the allocated memory:

```
Session -> FreeCallInfo(ci);
delete ci;
```

The `IPB_Arguments` and `IPB_Value` interfaces have methods that enable you to pass values between the PBVM and PowerBuilder extension modules using `PBCallInfo` to hold the data.

4.2.2 IPB_Arguments interface

The `IPB_Arguments` interface has two methods:

- `GetCount` obtains the number of arguments in a method call.
- `GetAt` obtains the value at a specific index of the `pArgs` member of the `PBCallInfo` structure. For each argument, `GetAt` returns a pointer to the `IPB_Value` interface.

The following code fragment uses `GetCount` and `GetAt` in a FOR loop to process different argument types. The `ci->pArgs->GetCount()` statement gets the number of arguments, and `ci->pArgs->GetAt(i)` gets the value at the index `i`. This value is a pointer to the `IPB_Value` interface on which `IPB_Value` methods, such as `IsArray` and `GetArray`, can be called (see [IPB_Value interface](#)):

```
int i;
for (i=0; i < ci->pArgs->GetCount();i++)
{
    pbuint ArgsType;
    if( ci->pArgs->GetAt(i)->IsArray()
        pArguments[i].array_val =
        ci->pArgs->GetAt(i)->GetArray();
        continue;
    }

    if( ci->pArgs->GetAt(i)->IsObject()
    {
        if (ci->pArgs->GetAt(i)->IsNull())
            pArguments[i].obj_val=0;
        else
            pArguments[i].obj_val =
            ci->pArgs->GetAt(i)->GetObject();
        continue;
    }
    ...
}
```

4.2.3 IPB_Value interface

`IPB_Value` has three sets of methods: helper methods, set methods, and get methods.

Helper methods

The `IPB_Value` interface helper methods provide access to information about variables and arguments, including the value's class and type, whether it is an array or simple type, whether it is set by reference, and whether the null flag is set. There is also a method that sets the value to null:

```
virtual pbclass      GetClass() const = 0;
virtual pbint       GetType() const = 0;
virtual pbboolean   IsArray() const = 0;
virtual pbboolean   IsObject() const = 0;
virtual pbboolean   IsByRef() const = 0;
virtual pbboolean   IsNull() const = 0;
virtual PBXRESULT   SetToNull() = 0;
```

The example shown in the previous section, [IPB_Arguments interface](#), shows how you can use three of these methods: `IsArray`, `IsObject`, and `IsNull`.

This example shows how you can use the `SetToNull` method to set the `returnValue` member of the `PBCallInfo` structure to null:

```
if ( ci->pArgs->GetAt(0)->IsNull() ||
    ci->pArgs->GetAt(1)->IsNull() )
{
    ...
}
```

```
// if either of the passed arguments is null,
// return the null value
ci->returnValue->SetToNull();
```

Set methods

The IPB_Value set methods set values in the PBCallInfo structure. There is a set method for each PowerBuilder datatype: SetInt, SetUInt, SetLong, SetUlong, and so on. These methods automatically set the value represented by IPB_Value to not null. The syntax is:

```
virtual PBXRESULT Set<type>(<pdtype> arg);
```

For example, the SetLong method takes an argument of type pblong.

In this example, the method has two integer arguments, set to int_val1 and int_val2:

```
ci-> pArgs -> GetAt(0) -> SetInt(int_val1);
ci-> pArgs -> GetAt(1) -> SetInt(int_val2);
```

The IPB_Value set methods set the datatype of the value represented by IPB_Value to a specific type. If the original type of the value is any, you can set it to any other type. Then, because the value now has a specific type, setting it to another type later returns the error PBX_E_MISMATCHED_DATA_TYPE. If the argument is readonly, the error PBX_E_READONLY_ARGS is returned.

Get methods

The IPB_Value get methods obtain values from the PBCallInfo structure. There is a get method for each PowerBuilder datatype: GetInt, GetUInt, GetLong, GetUlong, and so on. The syntax is:

```
virtual <pdtype> Get<type>( );
```

For example, the GetString method returns a value of type pbstring.

The following example uses the IPB_Value GetAt method to assign the value at the first index of the pArgs member of the PBCallInfo structure to a variable of type IPB_Value* called pArg. If pArg is not null, the GetLong method sets the variable longval to the value in pArg:

```
PBCallInfo *ci
...
pblong longval = NULL;
IPB_Value* pArg = ci-> pArgs-> GetAt(0);
if (!pArg->IsNull())
    longval = pArg -> GetLong();
```

If the value is null, or if you use a get method that is expected to return one datatype when the value is a different datatype (such as using GetLong when the datatype is parray), the result returned is undetermined.

The get methods can also be used with the returnValue member of PBCallInfo:

```
ret_val = ci.returnValue->GetInt();
return ret_val;
```

4.3 Using the IPB_Session interface

The IPB_Session interface is an abstract interface that enables the PBVM to interact with PowerBuilder extensions and with external applications. It defines hundreds of methods

for accessing PowerScript variables, calling PowerScript methods, handling exceptions, and setting a marshaler to convert PowerBuilder data formats to the user's communication protocol.

The IPB_Session interface includes several categories of methods:

- Class accessor methods are used to find PowerBuilder classes, call PowerBuilder methods and events, and get and set instance variables of PowerBuilder objects.
- Exception-handling methods communicate with the PowerBuilder exception handling mechanism.
- Array accessor methods create and access PowerBuilder bounded and unbounded arrays.
- Result set accessor methods work with result sets in DataStores and DataWindow controls.
- Typed data access methods create and access data of the PowerBuilder types string, double, decimal, blob, date, time, datetime, and so forth.
- Proxy access methods provide an interface for the implementation of new protocols.
- The Release method releases the IPB_Session object itself.

For a complete list of methods, see [IPB_Session interface](#).

You use IPB_Session methods in conjunction with IPB_Value and IPB_Arguments methods.

The following code fragment shows the body of a method that tests whether a date passed to a PBNI function is handled correctly by a PowerBuilder function. It uses the IPB_Value SetToNull, SetDate, and IsNull methods to set and test the date values in the PBCallInfo structure, as well as the IPB_Session SplitDate, SetDate, and NewDate methods.

```
// boolean isNull[], pbject myobj,
// and pdate* d_date arguments passed in
pbclass cls;
pbmethodID mid;
PBCallInfo* ci = new PBCallInfo;
pdate ret_date;
pbint yy,mm,dd;

cls = Session-> GetClass(myobj);
mid = Session-> GetMethodID(cls,"uf_getdate_byref",
    PBRT_FUNCTION,"YR");
Session-> InitCallInfo(cls, mid, ci);

if (isNull[0])
    ci -> pArgs -> GetAt(0)->SetToNull();
else
    ci-> pArgs -> GetAt(0) ->SetDate(*d_date);

Session->InvokeObjectFunction(myobj, mid, ci);

Session->SplitDate(ci->pArgs->GetAt(0)->GetDate(),
    &yy,&mm,&dd);
Session->SetDate(*d_date, yy, mm, dd);

if (ci-> returnValue ->IsNull())
{
```

```
ret_date = Session-> NewDate();
Session-> SetDate(ret_val, 1900, 1, 1);
}
else
{
ret_date = Session-> NewDate();
Session -> SplitDate(ci-> returnValue -> GetDate(),
    &yy, &mm, &dd);
Session -> SetDate(ret_val, yy, mm, dd);
}
Session -> FreeCallInfo(ci);
delete ci;
return ret_date;
```

4.4 Saving data from IPB_Value to a local variable

To avoid memory leaks, you must call `FreeCallInfo` to free the values stored in the `PBCallInfo` structure after using the structure. However, after making a function call, you might want to save the return value or a by reference argument value into a local variable you can use later.

There are techniques for saving values so they are still available after the call to `FreeCallInfo`. How you save your result into a local variable depends on whether you want to save a simple value, a pointer value, or an object value.

Saving simple values

Saving simple values is straightforward. When you call one of the `IPB_Value` `Get<type>` methods for a simple value, such as `GetInt` or `GetReal`, the actual data is returned. As a result, you can simply save the values of any of the following datatypes:

`pbvalue_byte`

`pbvalue_int`

`pbvalue_uint`

`pbvalue_long`

`pbvalue_ulong`

`pbvalue_real`

`pbvalue_double`

`pbvalue_longlong`

`pbvalue_boolean`

`pbvalue_char`

Saving pointer values

A pointer value does not contain data. It contains a pointer to a memory location where the data is stored. When you call one of the `IPB_Value` `Get<type>` methods for a pointer value, such as `GetBlob` or `GetTime`, it returns a pointer to memory that is also pointed to by `IPB_Value`.

When you call `FreeCallInfo`, the memory to which `IPB_Value` points is released and the data is deleted. Because this is the same data pointed to by the pointer returned by the `Get<type>` method, that pointer can no longer be used to represent the data.

This applies to the following pointer value datatypes, as well as to the pbarray datatype:

pbvalue_dec

pbvalue_string

pbvalue_blob

pbvalue_date

pbvalue_time

pbvalue_datetime

If you want to save the data in a pointer value, you can use the `AcquireValue`, `AcquireArrayItemValue`, and `ReleaseValue` methods to acquire and release the data. These methods clone a new `IPB_Value` that is not freed until you call `ReleaseValue` and reset the existing `IPB_Value` pointer.

Can be used for other datatypes

You can use `AcquireValue` and `AcquireArrayItemValue` to acquire values of any datatype.

Like the `Get<type>` methods, `AcquireValue` and `AcquireArrayItemValue` return a pointer to the memory where the data is stored, but they also reset the `IPB_Value` pointer so that `IPB_Value` no longer points to the actual data. When you call `FreeCallInfo`, the data pointed to by the value acquired using `AcquireValue` and `AcquireArrayItemValue` is unaffected.

The original value is reset to zero or null, so it can no longer be used. Attempts to get or acquire the original value return zero or null until another `IPB_Value` is set to the value.

If the `IPB_Value` acquired using `AcquireValue` is an array, the entire array is acquired. To acquire only an element of the array, use `AcquireArrayItemValue`. When you have finished using the data, you must free the memory using the `ReleaseValue` method.

The processing that the `AcquireArrayItemValue` and `ReleaseValue` methods perform results in poor performance when handling large arrays. It is more efficient to get the type of the array and handle each type with appropriate type-specific functions.

Caution

You must call the `ReleaseValue` method to free the data. If you do not do so, a memory leak will occur. You must not call `ReleaseValue` to release a pointer that was not acquired using `AcquireValue` and `AcquireArrayItemValue`. Doing so might cause the PBVM to crash.

Saving object values

Strictly speaking, object values are also pointer values, but the PBVM handles them differently. You use the `IPB_Session` `AddLocalRef` and `AddGlobalRef` methods to add a reference to the object. If there is a reference to an object, it is not deleted when `FreeCallInfo` is called.

When you no longer need the object, call `RemoveLocalRef` or `RemoveGlobalRef` to decrease the reference count for the object. If the reference count is decreased to zero, the object is deleted automatically.

There is an important difference between `AddLocalRef` and `AddGlobalRef`. A reference added by `AddLocalRef` can be deleted automatically when the local frame is popped up. The local frame can be popped by calling `PopLocalFrame` or when the current function returns. However, a reference added by `AddGlobalRef` is deleted only when `RemoveGlobalRef` is called or the session ends.

You must use these methods in pairs; that is, use `RemoveLocalRef` to remove references created with `AddLocalRef`, and use `RemoveGlobalRef` to remove references created with `AddGlobalRef`.

4.5 Using variables throughout a session

The `SetProp` function enables you to use a variable value throughout an IPB session without using a global variable, which is susceptible to namespace conflicts with other sessions. `SetProp` is one of a set of three functions:

- Use `SetProp` to register a new variable with the session or to change the value of an existing variable.
- Use `GetProp` to access the variable.
- Use `RemoveProp` to remove the variable from the list of variables associated with the session when it is no longer needed.

Suppose you want to throw an exception from within a PBNI extension and the exception itself is also defined by the PBNI extension. You call the `IPB_Session NewObject` function to create an instance of the exception, causing the `PBX_CreateNonVisualObject` function to be called.

One way to set the value of the fields of the exception before the function returns in a thread-safe manner is to create a new object or structure to hold the exception information before calling `NewObject`. You can call `SetProp` to store the structure or the object in the current `IPB_Session`. When `PBX_CreateNonVisualObject` is called, you can call `GetProp` to get the structure or object to obtain the exception information, then call `RemoveProp` to remove the data you stored in the current session.

You can also use these functions when initializing and uninitializing a session. If the extension exports the `PBX_NOTIFY` function, the PBVM calls `PBX_Notify` immediately after an extension PBX is loaded and just before the PBX is unloaded. You can use this function to initialize and uninitialize a session. For example, you could create a session manager object, and store it in the IPB session using the `SetProp` function. Later, you could use `GetProp` to obtain the session object.

4.6 Handling enumerated types

The `GetEnumItemValue` and `GetEnumItemName` functions allow you to convert the name of an enumerated value to an integer value, and to convert an integer value to the name of an enumerated value.

This example gets the numeric value for the `boolean!` enumerated value, then uses it to return the string value:

```
pblong lType = session->GetEnumItemValue("object",
```

```
boolean" ); // returns 138
LPCTSTR szEnum = session->GetEnumItemName( "object",
lType ); // returns "boolean"
```

Notice that the second argument in the `GetEnumItemValue` call, the enumerated value, must not have an appended exclamation mark (!).

To return an enumerated value from an extension to PowerScript, use the `SetLong` function to set the value of the enumerated variable into `IPB_Value` (you cannot use `SetInt` or `SetShort`).

To obtain an enumerated variable's value, you can use `GetInt` or `GetShort` as well as `GetLong`, as long as the value is in the appropriate range. For example, if you attempt to use `GetInt` to obtain a value that is more than 32767, the returned value is truncated.

5 Calling PowerBuilder from C++

About this chapter

A third-party application or server written in C++ can load the PowerBuilder VM, use PowerBuilder nonvisual objects, and use PowerBuilder visual controls. This chapter uses some simple examples to illustrate the process.

5.1 About calling PowerScript from C++ applications

If you have a PowerBuilder custom class user object that performs intensive programming that would be useful to an application that you need to write in C++, you can access the object directly from the C++ application using PBNI. You do not need to make the user object into a COM component or automation server.

To call functions on a PowerBuilder object, you can embed the PBVM in the C++ application. The C++ application must load the PBVM by loading pbvm170.dll with the Windows LoadLibrary function, get a pointer to the IPB_VM interface by calling the PB_GetVM function exported by pbvm170.dll, and create a session by calling the IPB_VM CreateSession function.

The application can then create an instance of the PowerBuilder class and invoke its functions through the IPB_Session interface.

The following figure illustrates the relationship between the C++ application and the interfaces provided by the PBVM.

Figure: Embedding the PBVM in a C++ application

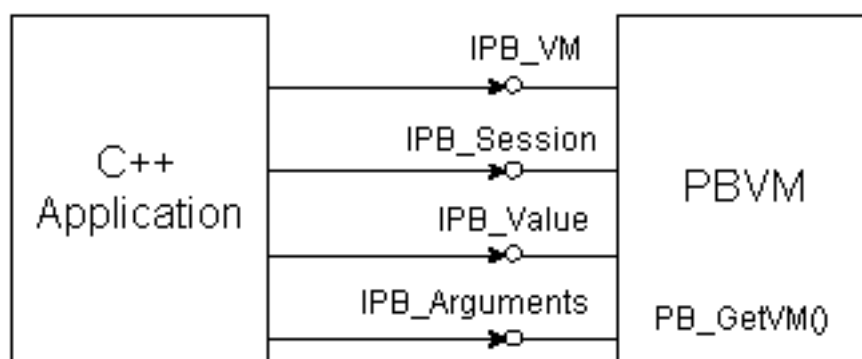

5.2 Calling PowerBuilder objects from C++

This section presents a simple example that illustrates how to call a function on a PowerBuilder custom class user object from a C++ application:

- [Creating a PowerBuilder object to be called from C++](#)
- [Getting the signature of a function](#)
- [Creating the C++ application](#)
- [Running the C++ application](#)

5.2.1 Creating a PowerBuilder object to be called from C++

To keep the code for this example simple, create an application with one custom class user object that has one function. The function returns the product of two integers:

1. In PowerBuilder, create a new workspace.
2. Select the Application icon from the Target page of the New dialog box and name the application loadpbvm.
3. Select the Custom Class icon from the PB Object page of the New dialog box.
4. In the Function prototype window, create a function with this signature:

```
f_mult ( integer arg1, integer arg2 ) returns integer
```

5. Save the user object as nvo_mult and close the User Object painter.

5.2.2 Getting the signature of a function

To write the C++ code that invokes the `f_mult` function, you need to obtain its method ID. The method ID is used to initialize the `PBMethodInfo` structure and to invoke the function. There are two `IPB_Session` functions that return a method ID: `GetMethodID`, which takes a signature, and `FindMatchingFunction`, which takes a comma-separated list of arguments. You use the same functions when you call PowerScript from the code in your extension; see [Calling PowerScript from an extension](#).

If you want to use `GetMethodID`, you need a signature. This function is simple enough that you do not need a tool to obtain a signature -- the signature is the string `III`, which indicates that the function returns an integer and takes two integers as arguments.

For more complicated functions, you can get the signature from the System Tree or with the `pbsig170` tool.

Getting a signature from the System Tree

To get the signature of `f_mult` in the System Tree, expand `nvo_mult`, right-click on the `f_mult` function, and select Properties from the pop-up menu. The signature displays in the Properties dialog box in the Signature text box:

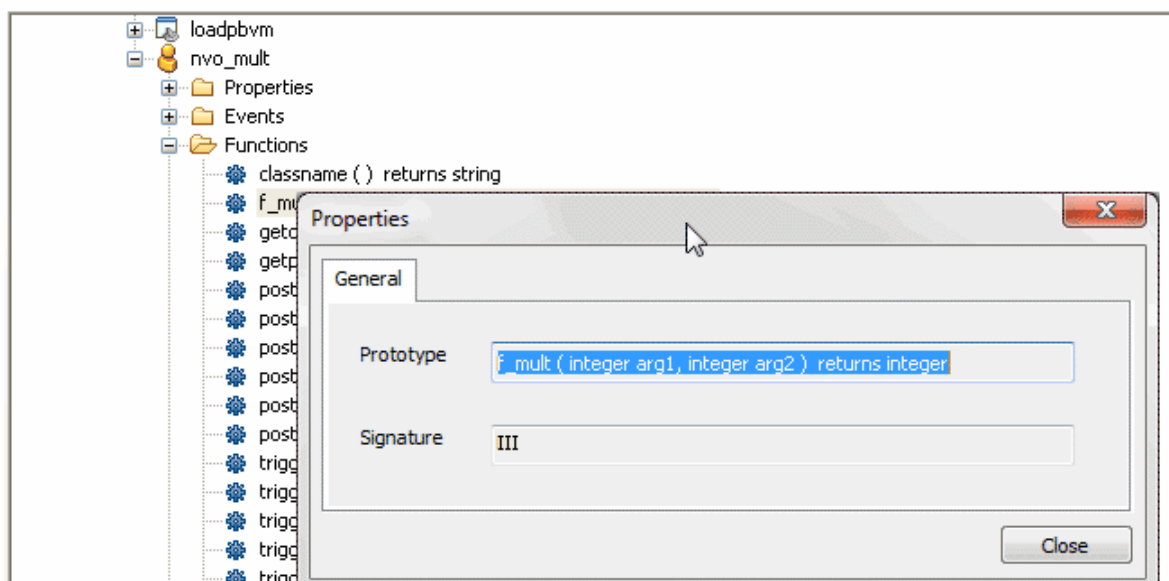

Getting a signature using pbsig170

To get the signature of `f_mult` with `pbsig170`, type the following at a command prompt:

```
pbsig170 d:\pbls\loadpbvm.pbl
```

In the output of `pbsig170`, the comment on the last line contains the signature to be passed as the method ID argument to `GetMethodID`:

```
PB Object Name: loadpbvm
PB Object Name: nvo_mult    public function integer f_mult (integer arg1,
                           integer arg2)
                           /* III */
```

For more information about the `pbsig170` tool and the format of method signatures, see [pbsig170](#).

5.2.3 Creating the C++ application

To create the C++ application, follow these steps:

1. [Load the PowerBuilder VM](#)
2. [Call PB_GetVM to get a pointer to the IPB_VM interface](#)
3. [Create an IPB_Session object within IPB_VM](#)
4. [Create an instance of the PowerBuilder object](#)
5. [Initialize the PBCallInfo structure](#)
6. [Call the PowerBuilder function](#)
7. [Write cleanup code](#)

5.2.3.1 Load the PowerBuilder VM

In your C++ development tool, create a new console application project. The include directory for the PBNI SDK, typically PowerBuilder 2017\SDK\PBNI\include, must be in your include path. If you use any helper classes, the source file that contains them must be added to your project. For a list of files and helper classes, see the table in [The PBNI SDK](#).

The code for the C++ application creates an IPB_VM object using the PB_GetVM function and loads the PowerBuilder VM:

```
#include "pbext.h"
#include "stdio.h"

typedef PBXEXPORT PBXRESULT (*P_PB_GetVM)(IPB_VM** vm);

int main(int argc, char *argv[])
{
    IPB_Session* session;
    IPB_VM* pbvm = NULL;

    //Load the PowerBuilder VM module
    HINSTANCE hinst = LoadLibrary("pbvm170.dll");
    if ( hinst== NULL) return 0;
    fprintf(stderr, "Loaded PBVM successfully\n");
```

5.2.3.2 Call PB_GetVM to get a pointer to the IPB_VM interface

The next step is to call the PB_GetVM function to get a pointer to the IPB_VM interface:

```
P_PB_GetVM getvm = (P_PB_GetVM)GetProcAddress
    (hinst,"PB_GetVM");
if (getvm == NULL) return 0;

getvm(&pbvm);
if (pbvm == NULL) return 0;
```

5.2.3.3 Create an IPB_Session object within IPB_VM

Next create an IPB_Session object within IPB_VM, using the PowerBuilder application's name and library list as arguments:

```
// loadpbvm.pbl must contain an application object
// named loadpbvm and it must be on the search path
// for the executable file
LPCTSTR LibList[] = {"loadpbvm.pbl"};
if ( pbvm->CreateSession("loadpbvm", LibList, 1,
    &session) != PBX_OK )
{
    fprintf(stderr, "Error in CreateSession\n");
    return 1;
}
fprintf(stderr, "Created session successfully\n");
```

5.2.3.4 Create an instance of the PowerBuilder object

After the session has been created, the C++ application can create PowerBuilder objects and call PowerBuilder functions in that session.

You use the FindGroup function to locate the group that contains the user object you want to use. FindGroup takes the name of the object as its first argument, and an enumerated

type as its second argument. You are looking for a user object, so the second argument is `pbgroup_userobject`.

You pass the group returned from `FindGroup` to the `FindClass` function to get a class that you can pass to the `NewObject` function:

```
// Create the PowerBuilder object contained
// in loadpbvm.pbl.
// First find the group that contains the
// user object nvo_mult
pbgroup group = session->FindGroup("nvo_mult",
    pbgroup_userobject);
if (group == NULL) return 0;
    // Now find the class nvo_mult in the group
pbclass cls = session->FindClass(group,"nvo_mult");
if (cls == NULL) return 0;
    // Create an instance of the PowerBuilder object
pbobject pboobj = session->NewObject(cls);
```

5.2.3.5 Initialize the PBCallInfo structure

Next, get the method ID for the function you want to call and initialize a `PBCallInfo` structure. You pass the signature obtained in [Getting the signature of a function](#) to the `GetMethodID` function:

```
// PBCallInfo contains arguments and return value
PBCallInfo ci;

// To call the class member function f_mult,
// pass its signature as the last argument
// to GetMethodID
pbmethodID mid = session->GetMethodID(cls, "f_mult",
    PBRT_FUNCTION, "III");

// Initialize call info structure based on method ID
session->InitCallInfo(cls, mid, &ci);
```

You could use `FindMatchingFunction` instead of `GetMethodID` to get the method ID. The call would look like this, because `f_mult` takes two integer arguments:

```
pbmethodID mid = session->FindMatchingFunction(cls,
    "f_mult", PBRT_FUNCTION, "int, int");
```

5.2.3.6 Call the PowerBuilder function

Before you call the function, you must supply the integers to be multiplied. For the sake of simplicity, the following code sets them directly in the `PBCallInfo` structure.

```
// Set IN arguments. The prototype of the function is
// integer f_mult(integer arg1, integer arg2)
ci.pArgs-> GetAt(0)->SetInt(123);
ci.pArgs-> GetAt(1)->SetInt(45);
```

Finally call the function, wrapping it in a try-catch statement to handle any runtime errors:

```
// Call the function
try
{
    session->InvokeObjectFunction(pboobj, mid, &ci);

    // Was PB exception thrown?
    if (session->HasExceptionThrown())
```

```

    {
        // Handle PB exception
        session->ClearException();
    }
}
catch (...)
{
    // Handle C++ exception
}

// Get the return value and print it to the console
pbint ret = ci.returnValue->GetInt();
fprintf(stderr, "The product of 123 and 45 is %i\n",
    ret);

```

5.2.3.7 Write cleanup code

When you have finished with the PBCallInfo structure, call FreeCallInfo to release the memory allocated to it, then delete the structure, release the session, and free the library:

```

// Release Call Info
session->FreeCallInfo(&ci);
delete &ci;

// Release session
session->Release();
return 0;
FreeLibrary(hinst);
}

```

5.2.4 Running the C++ application

When you run the compiled executable file at the command prompt, if the PowerBuilder VM is loaded and the session is created successfully, the following output displays in the command window:

```

Loaded PBVM successfully
Created session successfully
The product of 123 and 45 is 5535

```

5.3 Accessing result sets

You can use the IPB_ResultSetAccessor interface to access result sets in PowerBuilder. Use the IPB_Session GetResultSetAccessor method to create an instance of the interface using a result set returned from PowerBuilder as the method's argument. You can then use the IPB_ResultSetAccessor's getColumnCount, GetRowCount, GetItemData, and GetColumnMetaData methods to obtain information from the result set.

GetItemData uses the IPB_RSItemData interface to handle the data in each cell in the result set. If the data has a date, time, or datetime datatype, it is stored in a PB_DateData, PB_TimeData, or PB_DateTimeData structure.

To create a result set that can be passed to PowerBuilder, use the IPB_Session CreateResultSet method. See [CreateResultSet](#) for an example.

5.4 Processing PowerBuilder messages in C++

You can open a PowerBuilder window from a C++ application or from an extension, but to make sure that events triggered in the window or control are processed, you need to

make sure that the C++ application processes PowerBuilder messages. The `IPB_Session ProcessPBMessage` function lets you do this.

Each time the `ProcessPBMessage` function is called, it attempts to retrieve a message from the PowerBuilder message queue and process it. The function is similar to the PowerBuilder `Yield` function, which yields control to other graphic objects and pulls messages from PowerBuilder objects and other graphic objects from the queue. However, `ProcessPBMessage` processes only one message at a time, and it processes only PowerBuilder messages.

Messages are added to the PowerBuilder message queue when you call the `PostEvent` function.

ProcessPBMessage must be called repeatedly

You need to make sure that the `ProcessPBMessage` function is called repeatedly. For most C++ applications, you can provide a message loop in the main function and insert the `IPB_Session ProcessPBMessage` function in the message loop. This is shown in the example that follows.

If you use Microsoft Foundation Classes (MFC), you cannot modify the built-in message loop. To ensure that the `ProcessPBMessage` function is called repeatedly, you can overload the `CWnd::WindowProc` function and insert `ProcessPBMessage` into the overloaded function:

```
LRESULT CCallPBVCtrl::WindowProc(UINT message,
    WPARAM wParam, LPARAM lParam)
{
    d_session->ProcessPBMessage();
    return CDialog::WindowProc(message, wParam, lParam);
}
```

5.4.1 Examples

The following code fragments are from a C++ program that opens a window. The window has a menu item that invokes the `Open` event of a PowerBuilder application.

Calling ProcessPBMessage

The call to `ProcessPBMessage` is in a loop in the `WinMain` function:

```
int __stdcall WinMain(HINSTANCE hInstance,
    HINSTANCE hPrevInstance,
    LPSTR lpCmdLine,
    int nCmdShow)
{
    MSG msg;

    WNDCLASSEX wcex;

    // initialization code omitted
    ...
    RegisterClassEx(&wcex);

    HWND hWnd = CreateWindow(szWndClsName,
        "OpenPBWindow", WS_OVERLAPPEDWINDOW,
        CW_USEDEFAULT, 0, CW_USEDEFAULT, 0, NULL, NULL,
        hInstance, NULL);

    if (!hWnd)
    {
```

```

    return FALSE;
}

ShowWindow(hWnd, nCmdShow);
UpdateWindow(hWnd);

try
{
    while (GetMessage(&msg, NULL, 0, 0))
    {
        TranslateMessage(&msg);
        DispatchMessage(&msg);

        // Call to ProcessPBMessage
        if (session)
            session->ProcessPBMessage();
    }
}
catch(...)
{
    MessageBox(NULL, "Exception occurs",
               "Exception", MB_OK);
}
return msg.wParam;
}

```

Loading the PBVM and triggering an event

In the WndProc function, when the WM_CREATE message is passed, the PBVM is loaded and the library list, containing openwin.pbl, is passed to CreateSession. When the user selects the menu item that opens the PowerBuilder window, the FindGroup, FindClass, and GetMethodID functions obtain the information needed to create a new application object, initialize the PBCallInfo structure, and trigger the application object's Open event:

```

LRESULT CALLBACK WndProc(HWND hWnd, UINT message,
    WPARAM wParam, LPARAM lParam)
{
    int wmId, wmEvent;
    PAINTSTRUCT ps;
    HDC hdc;

    switch (message)
    {
        case WM_CREATE:
        {
            // Load the PBVM
            hPBVMInst = ::LoadLibrary("pbvm170.dll");
            P_PB_GetVM getvm = (P_PB_GetVM)
                GetProcAddress(hPBVMInst, "PB_GetVM");
            IPB_VM* vm = NULL;
            getvm(&vm);

            // Define the library list and create the session
            static const char *liblist[] = {"openwin.pbl"};
            vm->CreateSession("openwin", liblist, 1,
                &session);
            break;
        }

        case WM_COMMAND:
            wmId    = LOWORD(wParam);
            wmEvent = HIWORD(wParam);
            // Parse the menu selections:
    }
}

```



```

switch (wmId)
{
case ID_PB_VISUAL:
{
// Initialize PBCallInfo and trigger the
// application open event
try
{
pbgroup group = session->FindGroup
("openwin", pbgroup_application);
pbclass cls = session->FindClass(group,
"openwin");
pbmethodID mid = session->GetMethodID
(cls, "open", PBRT_EVENT, "QS");
pbobject obj = session->NewObject(cls);

PBCallInfo ci;
session->InitCallInfo(cls, mid, &ci);
session->TriggerEvent(obj, mid, &ci);
session->FreeCallInfo(&ci);
}
catch(...)
{
MessageBox(NULL, "Exception occurs",
"Exception", MB_OK);
}
break;
}
default:
return DefWindowProc(hWnd, message, wParam,
lParam);
}
break;
case WM_PAINT:
hdc = BeginPaint(hWnd, &ps);
RECT rt;
GetClientRect(hWnd, &rt);
EndPaint(hWnd, &ps);
break;
case WM_DESTROY:
session->Release();
session = NULL;
FreeLibrary(hPBVMInst);
PostQuitMessage(0);
break;
default:
return DefWindowProc(hWnd, message, wParam,
lParam);
}
return 0;
}

```

Testing ProcessPBMessage

You can test the ProcessPBMessage function with a simple PowerBuilder application like this one:

1. Create a PowerBuilder application called openwin in openwin.pbl.
2. Create a main window, w_main, with three buttons.
3. Insert a window-level function, of_setcolor, that takes three integers as arguments and has this script:

```
this.backcolor = rgb(red,green,blue)
```

4. Insert a window-level user event, ue_test, with this script:

```
MessageBox("ue_test", "This is a user event")
```

5. Provide the following scripts for the clicked events of the buttons:

```
//cb_1:
MessageBox("Button 1", "Clicked")
parent.of_setcolor(255, 255, 0)

//cb_2:
MessageBox("Button 2", "Clicked")
parent.PostEvent("ue_event")
// not fired
parent.of_setcolor(255, 0, 0)

//cb_3:
MessageBox("Button 3", "Clicked")
cb_1.PostEvent(Clicked!) // not fired
```

6. Script the application's Open event:

```
open (w_main)
```

When the ProcessPBMessage function is included in the C++ application, the application runs from C++ as it does in PowerBuilder. The posted events in cb_2 and cb_3 are processed.

Now try commenting out these lines in the C++ application, recompiling, and running the application again:

```
if (session)
session->ProcessPBMessage();
```

The message boxes still display (response windows have their own message loop) and the of_setcolor function is called, but the posted events do not fire.

5.5 More PBNI possibilities

The ability to create visual, nonvisual, and marshaler extensions, and to call PowerBuilder objects from external C++ applications, opens up numerous opportunities to combine these capabilities to develop more complex applications.

Writing an extension that loads the PBVM

Most of the examples in this book and on the PowerBuilder Code Samples Web site at <https://www.appeon.com/developers/library/code-samples-for-pb> show you how to create an extension in C++ and use it in PowerBuilder, or how to write a C++ application that loads the PowerBuilder VM.

You could also write an extension that loads the PowerBuilder VM and uses a custom class user object, using the techniques described in this chapter. The following figure depicts the interaction between the PBVM and an external application that uses an extension.

Figure: Interaction between PBNI, the PBVM, and external applications

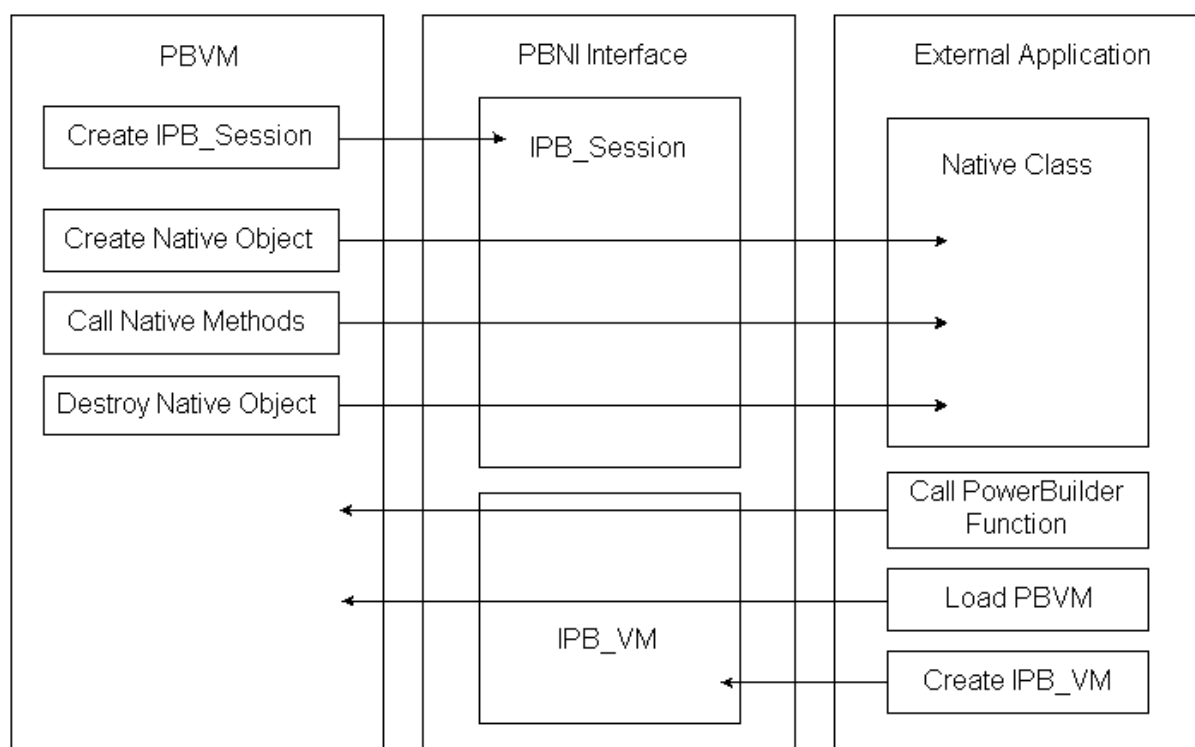

Calling PowerBuilder from Java

You can combine the ability to call PowerBuilder classes from C++, as described in this chapter, with the ability to create marshaler extensions, as described in [Creating Marshaler Extensions](#) to call PowerBuilder from Java.

One way to do this is to create a Java proxy class that declares static native methods that can be called to load the PBVM, create PowerBuilder sessions, create PowerBuilder objects, and invoke PowerScript functions. These native methods can call into the PBVM through PBNI. Additional Java classes that represent the PBVM, PowerBuilder sessions, and PowerBuilder objects can be based on the proxy class.

The Java classes call the Java native methods through JNI, whereas the Java native methods call PowerBuilder through PBNI.

There is a sample that illustrates these techniques on the PowerBuilder Code Samples Web site at <https://www.appeon.com/developers/library/code-samples-for-pb>.

Part II. Reference

This part contains reference information for PBNI datatypes, interfaces, and tools.

6 PBNI Types and Return Values

About this chapter

This chapter contains information about the datatypes, enumerated types, and error return values used by the PowerBuilder Native Interface.

6.1 PowerBuilder to PBNI datatype mappings

The following table maps PowerBuilder datatypes to predefined datatypes used in PBNI C++ modules.

Table 6.1: Predefined datatype mappings

PowerBuilder datatype	Predefined datatype
Int	pbint
UInt	pbuint
Byte	pbbyte
Long	pblong
Longlong	pblonglong
Ulong	pbulong
Boolean	pbboolean
Real	pbreal
Double	pbdouble
Decimal	pbdec
Date	pbdate
Time	pbtime
DateTime	pbdatetime
Char	pbchar
Blob	pbblob
String	pbstring
Powerobject	pbobject

6.2 Types for access to PowerBuilder data

The types in the following table enable access to PowerBuilder data.

Table 6.2: Types for access to PowerBuilder data

Datatype	Description
pbgroup	Used to access PowerBuilder group information. A group is a container of PowerBuilder classes.
pbclass	Used to access PowerBuilder class definition information.

Datatype	Description
pbmethodID	Used to access the method ID of a PowerBuilder global or member function.
pbfieldID	Used to access an instance variable.
pbarray	Used to access array information and data items.

6.3 PBNI enumerated types

Enumerated types for PowerBuilder groups

The pbgroup_type enumerated types are used in IPB_Session FindGroup calls to identify the type of group required.

Table 6.3: Enumerated types for PowerBuilder groups

Value	PowerBuilder object
pbgroup_application	Application
pbgroup_datawindow	DataWindow definition
pbgroup_function	Global function
pbgroup_menu	Menu
pbgroup_proxy	Proxy definition for a remote object
pbgroup_structure	PowerBuilder structure type
pbgroup_userobject	PowerBuilder user object
pbgroup_window	Window
pbgroup_unknown	Unknown group

Enumerated types for PowerBuilder values

The pbvalue_type enumerated types are used in methods such as the IPB_Value GetType method and the IPB_Session NewUnboundedSimpleArray method to identify the type of PowerBuilder data.

Table 6.4: Enumerated types for PowerBuilder values

Value	PowerBuilder datatype
pbvalue_notype	Undetermined datatype.
pbvalue_int	Int
pbvalue_uint	UInt
pbvalue_byte	Byte
pbvalue_long	Long
pbvalue_longlong	Longlong
pbvalue_ulong	Ulong
pbvalue_real	Real
pbvalue_double	Double

Value	PowerBuilder datatype
pbvalue_dec	Decimal
pbvalue_string	String
pbvalue_boolean	Boolean
pbvalue_any	Any (changed to another datatype when set explicitly)
pbvalue_blob	Blob
pbvalue_date	Date
pbvalue_time	Time
pbvalue_datetime	DateTime
pbvalue_char	Char

Enumerated types for PowerBuilder routines

The `pbrt_type` enumerated types are used in `IPB_Session GetMethodID` calls to identify the type of routine required.

Table 6.5: Enumerated types for PowerBuilder routines

Value	Routine type
PBRT_FUNCTION	Function
PBRT_EVENT	Event

6.4 Error return values

The following table shows the `PBXRESULT` return values and error codes returned from PBNI methods.

Table 6.6: PBXResult return values

Value of PBXResult	Error code
PBX_OK	0
PBX_SUCCESS	0
PBX_FAIL	-1
PBX_E_NO_REGISTER_FUNCTION	-1
PBX_E_REGISTRATION_FAILED	-2
PBX_E_BUILD_GROUP_FAILED	-3
PBX_E_INVALID_ARGUMENT	-4
PBX_E_INVOKE_METHOD_INACCESSIBLE	-5
PBX_E_INVOKE_WRONG_NUM_ARGS	-6
PBX_E_INVOKE_REFARG_ERROR	-7
PBX_E_INVOKE_METHOD_AMBIGUOUS	-8
PBX_E_INVOKE_FAILURE	-9

Value of PBXResult	Error code
PBX_E_MISMATCHED_DATA_TYPE	-10
PBX_E_OUTOF_MEMORY	-11
PBX_E_GET_PBVM_FAILED	-12
PBX_E_NO_SUCH_CLASS	-13
PBX_E_CAN_NOT_LOCATE_APPLICATION	-14
PBX_E_INVALID_METHOD_ID	-15
PBX_E_READONLY_ARGS	-16
PBX_E_ARRAY_INDEX_OUTOF_BOUNDS	\$100

7 PBNI Interfaces, Structures, and Methods

About this chapter

This chapter contains reference information about the classes, structures, and methods of the PowerBuilder Native Interface.

7.1 Header file contents

PBNI classes and interfaces are defined in a set of header files.

pbni.h

The classes, structures, and methods defined in the header file `pbni.h` allow PowerBuilder extension modules to interact with PowerBuilder. This file also includes the `pbarray.h`, `pbfield.h`, and `pbnimd.h` header files.

pbarray.h, pbfield.h, pbtraits.h, and pbnimd.h

`pbarray.h` contains helper classes that make it easier to create arrays and access data in them. `pbfield.h` contains a helper class that makes it easier to access fields. Both header files rely on `pbtraits.h`, which provides specializations for the Value enumerated types. `pbnimd.h` contains machine-specific datatype definitions. These files should not be included directly in your code.

pbext.h

The classes, structures, and methods defined in the header file `pbext.h` must be implemented in PowerBuilder extension modules to allow PowerBuilder applications to use the extension modules. `pbext.h` includes `pbni.h` and `pbevtid.h`.

pbevtid.h

`pbevtid.h` contains mappings from PowerBuilder event strings to internal event identifiers. These mappings allow the PBVM to automatically fire events that you include in the description of an extension. For more information, see [Event processing in visual extensions](#).

pbrsa.h

`pbrsa.h` contains structures and interfaces used to access data in DataStores and DataWindow controls.

7.2 Class and interface summary

This table lists the classes and interfaces that make up PBNI. After the table, the classes and interfaces are listed in alphabetical order. The methods for each class are listed in alphabetical order after the class description.

Several additional helper classes that are defined in `pbni.h` are not listed in the table. These helper classes include:

- `PBArrayInfoHolder` and `PBCallInfoHolder` -- used to hold a `PBArrayInfo` or `PBCallInfo` variable and release it when it is out of scope
- `PBEventTrigger`, `PBObjectFunctionInvoker`, and `PBGlobalFunctionInvoker` -- used to trigger events and call object and global functions

Table 7.1: PBNI class and interface summary

Object	Description	Defined in
IPB_Arguments interface	Used to access the arguments of the PBCallInfo structure.	pbni.h
IPB_ResultSetAccessor interface	Used to access data in a DataWindow or DataStore.	pbrsa.h
IPB_RSItemData interface	Used to set data values in a result set from a DataWindow or DataStore.	pbrsa.h
IPB_Session interface	Used to interoperate with PowerBuilder. An abstract interface, it defines methods for accessing PowerScript data, calling PowerScript functions, catching and throwing PowerScript exceptions, and setting a marshaler to convert PowerBuilder data formats to the user's communication protocol.	pbni.h
IPB_Value interface	Used to hold PowerBuilder data, IPB_Value contains information about each variable, including its type, null flag, access privileges, array or simple type, and reference type.	pbni.h
IPB_VM interface	Used to load PowerBuilder applications in third-party applications and interoperate with the PowerBuilder virtual machine (PBVM).	pbni.h
PBArrayInfo structure	Used to hold information about arrays.	pbni.h
PBCallInfo structure	Used to hold arguments and return type information in function calls between PBNI and PowerBuilder.	pbni.h
PB_DateData structure	Used to pass data of type Date in the SetData function in the IPB_RSItemData interface.	pbrsa.h
PB_DateTimeData structure	Used to pass data of type DateTime in the	pbrsa.h

Object	Description	Defined in
	SetData function in the IPB_RSItemData interface.	
PB_TimeData structure	Used to pass data of type Time in the SetData function in the IPB_RSItemData interface.	pbrsa.h
PBX_DrawItemStruct structure	Used to hold the properties of an external visual control that you want to draw using the PBX_DrawVisualObject function.	pbext.h
PBArrayAccessor template class	Used to access items in an array.	pbarray.h
PBObjectArrayAccessor class	Used to access items in an object array.	pbarray.h
PBBoundedArrayCreator template class	Used to create bounded arrays.	pbarray.h
PBBoundedObjectArrayCreator class	Used to create bounded object arrays.	pbarray.h
PBUnboundedArrayCreator template class	Used to create unbounded arrays.	pbarray.h
PBUnboundedObjectArrayCreator class	Used to create unbounded object arrays.	pbarray.h
IPBX_Marshaler interface	Used to invoke remote methods and convert PowerBuilder data formats to the user's communication protocol. A marshaler extension is a PowerBuilder extension that acts as the bridge between PowerBuilder and other components, such as EJBs, Java classes, CORBA objects, Web services, and so on.	pbext.h
IPBX_NonVisualObject interface	Inherits from IPBX_UserObject and is the direct ancestor class of nonvisual PowerBuilder native classes.	pbext.h
IPBX_UserObject interface	The ancestor class of PowerBuilder native	pbext.h

Object	Description	Defined in
	classes. It has two functions, Destroy and Invoke.	
IPBX_VisualObject interface	Inherits from IPBX_UserObject and is the direct ancestor class of visual PowerBuilder native classes.	pbext.h
Exported methods	Some exported methods must be implemented in PowerBuilder extension modules.	pbext.h
Method exported by PowerBuilder VM	The PB_GetVM method is exported by the PowerBuilder VM and is used to pass the IPB_VM interface to the user.	pbni.h

7.3 IPB_Arguments interface

Description

The IPB_Arguments and IPB_Value interfaces are used to pass values between the PowerBuilder VM and PowerBuilder extension modules. Each argument is represented by a pointer to the IPB_Value interface.

Methods

The IPB_Arguments interface has two methods, [GetAt](#) and [GetCount](#).

7.3.1 GetAt

Description

Returns a pointer to the IPB_Value interface representing an argument whose order in the list of arguments is indicated by a specified index.

Syntax

```
GetAt ( pbint index )
```

Table 7.2:

Argument	Description
index	A valid index into the PBCallInfo structure

Return value

IPB_Value*

Examples

In the following code fragment, GetAt obtains the first value in the PBCallInfo structure. The value has been passed in from the calling function.

```
PBCallInfo ci;
LPCSTR myPBNIObj = NULL;
```

```
IPB_Value* pArg0 = ci->pArgs->GetAt(0);
if (!pArg0->IsNull())
{
    pbstring t = pArg0->GetString();
    if (t != NULL)
        myPBNIObj = session->GetString(t);
}
```

See also[GetCount](#)**7.3.2 GetCount****Description**

Obtains the number of arguments in an instance of PBCallInfo.

Syntax

```
GetCount ( )
```

Return value

pbint.

Examples

This example uses GetCount in a FOR loop used to process different argument types:

```
int i;
for (i=0; i < ci-> pArgs -> GetCount();i++)
{
    pbuint ArgsType;

    if( ci -> pArgs -> GetAt(i) -> IsArray())
        pArguments[i].array_val =
            ci -> pArgs -> GetAt(i) -> GetArray();
        continue;
    }

    if( ci -> pArgs -> GetAt(i) -> IsObject())
    {
        if (ci -> pArgs -> GetAt(i) -> IsNull())
            pArguments[i].obj_val=0;
        else
            pArguments[i].obj_val =
                ci -> pArgs -> GetAt(i) -> GetObject();
        continue;
    }
    ...
}
```

See also[GetAt](#)**7.4 IPB_ResultSetAccessor interface****Description**

The IPB_ResultSetAccessor interface is used to access result sets in DataWindow and DataStore objects.

Methods

The IPB_ResultSetAccessor interface has six methods:

[AddRef](#)

[GetColumnCount](#)

[GetColumnMetaData](#)

[GetItemData](#)

[GetRowCount](#)

[Release](#)

7.4.1 AddRef

Description

When you call the CreateResultSet function of interface IPB_Session, you need to pass an argument of type IPB_ResultSetAccessor. The AddRef function is called on that argument and the Release function is called when the pobject is destroyed.

Syntax

```
AddRef ( )
```

Return value

None.

See also

[CreateResultSet](#)

[GetColumnCount](#)

7.4.2 GetColumnCount

Description

Obtains the number of columns.

Syntax

```
GetColumnCount ( )
```

Return value

Unsigned long.

Examples

This statement stores the number of columns in *numCols:

```
*numCols = d_rsAccessor->GetColumnCount();
```

See also

[CreateResultSet](#)

[GetRowCount](#)

7.4.3 GetColumnMetaData

Description

Obtains a column's metadata. The column number of the first column is 1. Memory must be allocated for columnName before this function call. The pointer values can be null.

Syntax

```
GetColumnMetaData (unsigned long columnNum, LPTSTR columnName, pbvalue_type* type,
unsigned long* width )
```

Table 7.3:

Argument	Description
columnNum	The number of the column for which you want to obtain metadata
columnName	The name of the specified column
type	A pointer to the type of the specified column
width	A pointer to the width of the specified column

Return value

None.

Examples

This example gets the number of columns in a result set and allocates an array to hold the types of each column:

```
CRsltSet::CRsltSet(IPB_ResultSetAccessor* rsAccessor)
:m_lRefCount (0), d_rsAccessor(rsAccessor)
{
    rsAccessor->AddRef();
    // for each column
    ULONG nNumColumns = d_rsAccessor->GetColumnCount();
    d_arrColTypes = new USHORT[nNumColumns + 1];
    for (ULONG nColumn=1; nColumn <= nNumColumns;
        ++nColumn)
    {
        // get the column type into the array
        pbvalue_type type;
        d_rsAccessor->GetColumnMetaData (nColumn,
            NULL, &type, NULL);
        d_arrColTypes[nColumn] = (USHORT)type;
    }
}
```

See also

[CreateResultSet](#)

[GetColumnCount](#)

[GetItemData](#)

[GetRowCount](#)

7.4.4 GetItemData

Description

Accesses the data in a cell. The first row is 1 and the first column is 1.

Syntax

```
GetItemData(unsigned long row, unsigned long col, IPB_RSItemData* data)
```

Table 7.4:

Argument	Description
row	The row number of the cell
col	The column number of the cell
data	A pointer to an IPB_RSItemData structure

Return value

Boolean.

Examples

This example stores the data in the first row and column in the IPB_RSItemData structure sd:

```
d_rsAccessor->GetItemData(1, 1, &sd);
```

Usage

If the value of data is null, this function issues the callback data->SetNull. If the value is not null, it issues the callback data->SetData. For more information, examine the IPB_RSItemData interface.

See also

[CreateResultSet](#)

[GetColumnCount](#)

[GetColumnMetaData](#)

[GetRowCount](#)

[IPB_RSItemData interface](#)

[SetData](#)

[SetNull](#)

7.4.5 GetRowCount

Description

Obtains the number of rows.

Syntax

```
GetRowCount ( )
```

Return value

Unsigned long.

Examples

This statement stores the number of rows in *numRows:

```
*numRows = d_rsAccessor->GetRowCount();
```

See also[CreateResultSet](#)[GetColumnCount](#)[GetColumnMetaData](#)[GetItemData](#)**7.4.6 Release****Description**

When you call the `CreateResultSet` function of interface `IPB_Session`, you need to pass an argument of type `IPB_ResultSetAccessor`. The `AddRef` function is called on that argument and the `Release` function is called when the pobject is destroyed.

Syntax

```
Release ( )
```

Return value

None.

See also[AddRef](#)[CreateResultSet](#)**7.5 IPB_RSItemData interface****Description**

The `IPB_RSItemData` interface is used as an argument to the `GetItemData` function of `IPB_ResultSetAccessor`.

Methods

The `IPB_RSItemData` interface has two methods: [SetData](#) and [SetNull](#).

7.5.1 SetData**Description**

Sets the data in an `IPB_RSItemData` structure when the `GetItemData` function of `IPB_ResultSetAccessor` is called and the data value is not null.

Syntax

```
SetData(unsigned long len, void* data)
```

Table 7.5:

Argument	Description
len	The length of the data
data	A void pointer to the address of the data

Return value

None.

Usage

If the cell datatype is:

- string and decimal, the address points to a string
- date, the address points to a PB_DateData structure
- time, the address points to a PB_TimeData structure
- datetime, the address points to a PB_DateTimeData structure
- another datatype, the address points to data of the corresponding type

See also

[GetItemData](#)

[SetNull](#)

[PB_DateData structure](#)

[PB_DateTimeData structure](#)

[PB_TimeData structure](#)

7.5.2 SetNull

Description

Sets the data in an IPB_RSItemData structure to null when the GetItemData function of IPB_ResultSetAccessor is called and the data value is not null.

Syntax

```
SetNull()
```

Return value

None.

See also

[GetItemData](#)

[SetData](#)

7.6 IPB_Session interface

Description

The IPB_Session interface is used to interoperate with PowerBuilder. An abstract interface, it defines methods for accessing PowerScript data, calling PowerScript functions, catching and throwing PowerScript exceptions, and setting a marshaler to convert PowerBuilder data formats to the user's communication protocol.

Methods

This table lists functions by category. Full descriptions in alphabetic order follow the table.

Table 7.6: IPB_Session methods by category

Purpose	Method	Description
Managing sessions	Release	Releases this IPB session. The IPB_Session object becomes invalid after the call.
Managing object references	AddGlobalRef	Adds a global reference to the specified PowerBuilder object.
	AddLocalRef	Adds a local reference to the specified PowerBuilder object.
	NewObject	Creates a new object of the specified type.
	PopLocalFrame	Pops the current local reference frame from the current native method stack frame.
	PushLocalFrame	Pushes a local reference frame onto the current native method stack frame.
	RemoveGlobalRef	Removes a global reference to the specified PowerBuilder object.
	RemoveLocalRef	Removes a local reference to the specified PowerBuilder object.
Managing shared properties	GetProp	Retrieves a pointer to the data value of a variable that has been registered as a shared property for the current IPB session.
	RemoveProp	Removes the specified variable from the list of properties of the current IPB session.
	SetProp	Adds a new variable to the list of properties of the current session or changes the value of an existing variable.
Handling the PowerBuilder message queue	ProcessPBMessage	Checks the PowerBuilder message queue and, if there is a message in the queue, attempts to process it.

Purpose	Method	Description
Handling exceptions	ClearException	Clears the current PowerBuilder exception object.
	GetException	Obtains the current thrown exception object.
	HasExceptionThrown	Checks for the existence of an exception that has been thrown but not cleared.
	ThrowException	Throws a PowerBuilder exception or inherited exception, replacing the existing exception if one exists.
Passing arguments	Add<type>Argument	Adds an argument in a variable argument PowerBuilder call.
	FreeCallInfo	Frees memory allocated by InitCallInfo.
	InitCallInfo	Initializes the PBCallInfo structure.
Finding PowerBuilder classes and objects	FindGroup	Searches for a group with a given name and group type in the current library list.
	FindClass	Searches for a class with a given name within a given group.
	FindClassByClassID	Searches for a class with a given name and a given ID.
	GetClass	Returns the class handle of a PowerBuilder object.
	GetClassName	Returns the name of a class in lowercase.
	GetCurrGroup	Returns the name of the current group.
	GetSuperClass	Returns the base class of a class, if any.
	GetSystemClass	Returns the system class handle of a PowerBuilder object.
	GetSystemGroup	Returns the class that contains all the system global functions.

Purpose	Method	Description
	IsAutoInstantiate	Returns true if the specified class is an autoinstantiated class; otherwise returns false.
Working with functions and events	FindMatchingFunction	Finds a function that has the specified argument list.
	GetMethodID	Returns the ID of the requested function.
	GetMethodIDByEventID	Returns the ID of the function that has a given predefined PowerBuilder event ID.
	InvokeClassFunction	Invokes system or user global functions.
	InvokeObjectFunction	Invokes a class member function.
	TriggerEvent	Triggers a PowerBuilder event.
Working with enumerated variables	GetEnumItemName	Obtains the name of an enumerated variable.
	GetEnumItemValue	Obtains the value of an enumerated variable.
Working with global variables	GetGlobalVarID	Returns the name of a global variable.
	GetGlobalVarType	Returns the datatype of a global variable.
	Get<type>GlobalVar	Returns the value of a global variable of a specific datatype.
	GetPBAnyGlobalVar	Obtains the value of a global variable of type Any.
	IsGlobalVarArray	Returns true if the global variable contains an array, otherwise returns false.
	IsGlobalVarNull	Returns true if the global variable contains a null value, otherwise returns false.
	IsGlobalVarObject	Returns true if the global variable contains a pobject, otherwise returns false.
	Set<type>GlobalVar	Sets the value of a global variable of a specific datatype.

Purpose	Method	Description
	SetGlobalVarToNull	Sets the value of a shared variable to null.
Working with shared variables	GetSharedVarID	Returns the name of a shared variable.
	GetSharedVarType	Returns the datatype of a shared variable.
	Get<type>SharedVar	Returns the value of a shared variable of a specific datatype.
	GetPBAnySharedVar	Obtains the value of a shared variable of type Any.
	IsSharedVarArray	Returns true if the shared variable contains an array, otherwise returns false.
	IsSharedVarNull	Returns true if the shared variable contains a null value, otherwise returns false.
	IsSharedVarObject	Returns true if the shared variable contains a pobject, otherwise returns false.
	Set<type>SharedVar	Sets the value of a shared variable of a specific datatype.
	SetSharedVarToNull	Sets the value of a shared variable to null.
Working with arrays	Get<type>ArrayItem	Returns the value of an array item of a specific datatype.
	GetArrayInfo	Obtains information about an array.
	GetArrayItemType	Obtains the datatype of an item in an array.
	GetArrayLength	Returns the length of an array.
	GetPBAnyArrayItem	Obtains the value of an array item of type Any.
	IsArrayItemNull	Returns true if the array item contains an array, otherwise returns false.
	NewBoundedSimpleArray	Creates a bounded simple data array.

Purpose	Method	Description
	NewUnboundedSimpleArray	Creates an unbounded simple data array.
	NewBoundedObjectArray	Creates a bounded PowerBuilder object or structure array.
	NewUnboundedObjectArray	Creates an unbounded PowerBuilder object or structure data array.
	ReleaseArrayInfo	Releases memory returned by GetArrayInfo.
	Set<type>ArrayItem	Sets the value of an array item of a specific datatype.
	SetArrayItemToNull	Sets the value of an array item to null.
Working with strings	GetStringLength	Returns the length of a string in bytes without the terminator.
	GetString	Returns a pointer to the string passed in as an argument.
	NewString	Creates a new string.
	ReleaseString	Releases the memory used by a string.
	SetString	Frees an existing string and assigns a new string value to it.
Working with binary large objects	GetBlob	Returns a pointer to the data buffer for a blob.
	GetBlobLength	Returns the length in bytes of blob data in a buffer.
	NewBlob	Creates a new blob and duplicates a buffer for the new blob data.
	SetBlob	Destroys the existing data in a blob and copies data into it from a buffer.
Working with decimal values	GetDecimalString	Converts decimal data in a pbdec object to a string.
	NewDecimal	Allocates resources for a new decimal data object.
	ReleaseDecimalString	Frees the memory acquired using GetDecimalString.

Purpose	Method	Description
	SetDecimal	Converts a string to a decimal.
Working with date and time values	GetString	Converts data in a pdate object to a string.
	GetString	Converts data in a pdatetime object to a string.
	GetString	Converts data in a ptime object to a string.
	NewDate	Creates a new pdate data object.
	NewDateTime	Creates a new pdatetime data object.
	NewTime	Creates a new ptime data object.
	ReleaseDateString	Frees the memory acquired using GetString.
	ReleaseDateTimeString	Frees the memory acquired using GetString.
	ReleaseTimeString	Frees the memory acquired using GetString.
	SetDate	Resets the value of the specified pdate object.
	SetDateTime	Resets the value of the specified pdatetime object.
	SetTime	Resets the value of the specified ptime object.
	SplitDate	Splits the specified pdate object into a year, month, and day.
	SplitDateTime	Splits the specified pdatetime object into a year, month, and day.
	SplitTime	Splits the specified ptime object into a year, month, and day.
Working with data values	AcquireArrayItemValue	Clones the data in the PBCallInfo structure in an array item and resets the IPB_Value pointer.

Purpose	Method	Description
	AcquireValue	Clones the data in the PBCallInfo structure and resets the IPB_Value pointer.
	ReleaseValue	Frees the value acquired by the AcquireValue or AcquireArrayItemValue method.
	SetValue	Sets the value of one IPB_Value object to the value of another IPB_Value object
Working with fields	GetFieldID	Obtains the internal ID of a class instance variable.
	GetFieldName	Obtains the name of the specified field.
	GetFieldType	Obtains the datatype of a class instance variable.
	GetNumOfFields	Obtains the number of fields in the specified class.
	GetPBAnyField	Obtains the value of a variable of type Any.
	Get<type>Field	Obtains a pointer to the instance variable data for a specified variable.
	IsFieldArray	Returns true if the field contains an array, otherwise returns false.
	IsFieldNull	Returns true if the field contains a null value array, otherwise returns false.
	IsFieldObject	Returns true if the field contains a pobject, otherwise returns false.
	Set<type>Field	A set of datatype-specific functions. Sets the value of an instance field of an object.
	Set<type>Field	A set of datatype-specific functions. Sets the value of an instance field of an object.
	UpdateField	Refreshes a visual property of a PowerBuilder object.
Working with native classes	GetNativeInterface	Obtains a pointer to the interface of a native class.

Purpose	Method	Description
	IsNativeObject	Determines whether a pobject is an instance of a native class.
Accessing result sets from DataWindows and DataStores	CreateResultSet	Creates a result set object using a pointer to an IPB_ResultSetAccessor object.
	GetResultSetAccessor	Obtains an interface through which you can read data from a result set.
	ReleaseResultSetAccessor	Releases the pointer obtained using GetResultSetAccessor .
Working with marshaler extensions	GetMarshaler	Obtains the marshaler object associated with a proxy object.
	NewProxyObject	Creates a proxy for a remote object.
	SetMarshaler	Sets a marshaler that will be used to invoke remote methods and convert PowerBuilder data formats to the user's communication protocol.

7.6.1 AcquireArrayItemValue

Description

Clones the data in the PBCallInfo structure in an array item and resets the IPB_Value pointer.

Syntax

```
AcquireArrayItemValue( pbarray array, pblong dim[ ] )
```

Table 7.7:

Argument	Description
array	A valid pbarray structure.
dim	A pblong array to hold the indexes of all dimensions of the array. The size of the array must equal the dimensions of array.

Return value

IPB_Value*.

Examples

This FOR loop acquires the value of an item in an array and sets the value in another array:

```

for( i=1; i <= bound; i++)
{
    dim[0]= i;
    ipv = Session -> AcquireArrayItemValue(refArg, dim);
    Session -> SetArrayItemValue(*i_array, dim, ipv);
    Session -> ReleaseValue(ipv);
}

```

Usage

The `AcquireArrayItemValue` method enables you to retain the data in the `PBCallInfo` structure for a single array item.

The `AcquireArrayItemValue` method is independent of the type of the data but is most useful for acquiring the value of pointer values, such as `pbvalue_string`, `pbvalue_blob`, and so on. When you call `FreeInfo`, the data is not freed and the pointer returned by `AcquireArrayItemValue` is still valid.

When you no longer need the data, you must call the `ReleaseValue` method to free the data. Failing to do so causes a memory leak.

The PBVM clones a new `IPB_Value` and resets the existing one. If you attempt to get or acquire the original value, the value returned is zero or null until another `IPB_Value` is set to the value.

Working with large arrays

The processing that the `AcquireArrayItemValue` and `ReleaseValue` methods perform results in poor performance when handling large arrays. It is more efficient to get the type of the array and handle each type with appropriate type-specific functions.

See also

[ReleaseValue](#)

7.6.2 AcquireValue

Description

Clones the data in the `PBCallInfo` structure and resets the `IPB_Value` pointer.

Syntax

```
AcquireValue ( IPBValue* value )
```

Table 7.8:

Argument	Description
value	The value to be returned

Return value

`IPB_Value*`.

Examples

The `AcquireValue` method is used to obtain a message argument value. Later, when the value is no longer needed, it is released using `ReleaseValue` to avoid memory leaks:

```

// Acquire a value
MessageArg = session->AcquireValue
    ( ci->pArgs->GetAt(0) );
pbstring pbMessage = MessageArg->GetString() ;
Message = (LPSTR)session->GetString(pbMessage) ;
...
// Cleanup phase
if (MessageArg)
{
    Session->ReleaseValue ( MessageArg ) ;
}

```

Usage

The `AcquireValue` method enables you to retain the data in the `PBCallInfo` structure. The `AcquireValue` method is independent of the type of the data but is most useful for acquiring the value of pointer values such as `pbvalue_string`, `pbvalue_blob`, and so on. When you call `FreeInfo`, the data is not freed and the pointer returned by `AcquireValue` is still valid.

If the value acquired is an array, the entire array is acquired. To acquire a single element in an array, use the `AcquireItemValue` method.

When you no longer need the data, you must call the `ReleaseValue` method to free the data. Failing to do so causes a memory leak.

The PBVM clones a new `IPB_Value` and resets the existing one. If you attempt to get or acquire the original value, the value returned is zero or null until another `IPB_Value` is set to the value.

See also

[AcquireArrayItemValue](#)

[ReleaseValue](#)

7.6.3 Add<type>Argument

Description

Adds an argument of a specific type in a variable argument PowerBuilder call.

Syntax

```

AddArrayArgument ( PBCallInfo *ci, pbblob value, pbboolean IsNull )
AddBlobArgument ( PBCallInfo *ci, pbblob value, pbboolean IsNull )
AddBoolArgument ( PBCallInfo *ci, pbboolean value, pbboolean IsNull )
AddByteArgument ( PBCallInfo *ci, pbbyte value, pbboolean IsNull )
AddCharArgument ( PBCallInfo *ci, pbchar value, pbboolean IsNull )
AddDateArgument ( PBCallInfo *ci, pbdate value, pbboolean IsNull )
AddDateTimeArgument ( PBCallInfo *ci, pbdatetime value, pbboolean IsNull )
AddDecArgument ( PBCallInfo *ci, pbdec value, pbboolean IsNull )
AddDoubleArgument ( PBCallInfo *ci, pbdouble value, pbboolean IsNull )
AddIntArgument ( PBCallInfo *ci, pbint value, pbboolean IsNull )
AddLongArgument ( PBCallInfo *ci, pblong value, pbboolean IsNull )
AddLongLongArgument ( PBCallInfo *ci, pblonglong value, pbboolean IsNull )
AddObjectArgument ( PBCallInfo *ci, pbobject value, pbboolean IsNull )
AddPBStringArgument ( PBCallInfo *ci, pbstring value, pbboolean IsNull )
AddRealArgument ( PBCallInfo *ci, pbreal value, pbboolean IsNull )
AddStringArgument ( PBCallInfo *ci, LPCTSTR value, pbboolean IsNull )
AddTimeArgument ( PBCallInfo *ci, pbtime value, pbboolean IsNull )
AddUIntArgument ( PBCallInfo *ci, pbuint value, pbboolean IsNull )
AddULongArgument ( PBCallInfo *ci, pbulong value, pbboolean IsNull )

```

Table 7.9:

Argument	Description
ci	The PBCallInfo to which the argument is to be added.
value	The value to be added to the arguments array.
IsNull	Indicates whether the argument is null. The default is false.

Return value

PBXRESULT. PBX_OK on success.

Examples

This code tests that adding an integer argument to a PBCallInfo structure ci works correctly:

```
long Cmy_pbni:: f_Retrieve(IPB_Session* session, pbint retrieve_args, pobject
dwobj)
{
    pbclass cls;
    pbmethodID mid;
    PBCallInfo* ci = new PBCallInfo;
    pblong ret_val;
    PBXRESULT ret;

    cls = session-> GetClass(dwobj);
    mid = session-> GetMethodID
        (cls, "retrieve", PBRT_FUNCTION, "LAV");
    if (mid == kUndefinedMethodID)
        return -1;

    session-> InitCallInfo(cls, mid, ci);

    ci-> pArgs-> GetAt(0)-> SetInt(retrieve_args);
    session-> AddIntArgument(ci, retrieve_args, false);

    ret = session->InvokeObjectFunction(dwobj, mid, ci);
    if (ret != PBX_OK)
        ret_val = ret;
    else
        ret_val = ci-> returnValue-> GetLong();

    session-> FreeCallInfo(ci);
    delete ci;

    return ret_val;
}
```

Usage

This call is used in variable argument PowerBuilder calls, such as datawindow.retrieve(arg). After the call, the value returned by ci->pArgs->GetCount() increases by one.

See also

[GetCount](#)

[InvokeClassFunction](#)

[InvokeObjectFunction](#)

7.6.4 AddGlobalRef

Description

Adds a global reference to the specified PowerBuilder object.

Syntax

```
AddGlobalRef (pobject obj)
```

Table 7.10:

Argument	Description
obj	A valid PowerBuilder object handle

Return value

pbclass or null on error.

Examples

This example checks whether a return value is null, and if it is not, adds a global reference to it to the session:

```
if (ci-> returnValue-> IsNull())
    ret_val = 0;
else
    {
        ret_val = ci-> returnValue-> GetObject();
        Session -> AddGlobalRef(ret_val);
    }
}
```

See also

[RemoveGlobalRef](#)

7.6.5 AddLocalRef

Description

Adds a local reference to the specified PowerBuilder object.

Syntax

```
AddLocalRef (pobject obj)
```

Table 7.11:

Argument	Description
obj	A valid PowerBuilder object handle

Return value

pbclass or null on error.

Examples

This example defines functions that add and remove local references:

```
void MyPBNIClass::reference()
{
    d_session->AddLocalRef(d_pobject);
}
```

```

}
void MyPBNIClass::unreference()
{
    if(d_pobject != NULL)
        d_session->RemoveLocalRef(d_pobject);
}

```

See also[PopLocalFrame](#)[PushLocalFrame](#)[RemoveLocalRef](#)**7.6.6 ClearException****Description**

Clears the current PowerBuilder exception object.

Syntax

```
ClearException ()
```

Return value

None.

Usage

HasExceptionThrown returns false after a call to ClearException. If no exception has been thrown, this call has no effect.

See also[GetException](#)[HasExceptionThrown](#)[ThrowException](#)**7.6.7 CreateResultSet****Description**

Creates a result set object using a pointer to an IPB_ResultSetAccessor object.

Syntax

```
CreateResultSet (IPB_ResultSetAccessor* rs)
```

Table 7.12:

Argument	Description
rs	A pointer to an IPB_ResultSetAccessor object

Return value

pobject.

Examples

This example loads the PBVM and calls the `f_ret` and `f_in` functions in the custom class user object `n_rs` in the PBL `pbrs.pbl`. The PowerScript for the functions is shown after the C++ code:

```
#include "stdafx.h"
#include "windows.h"
#include "pbni.h"
#include "vector"
using std::vector;

void main(int argc, char* argv[])
{
    HINSTANCE hinst = LoadLibrary("pbvm170.dll");

    typedef PBXRESULT (*P_PB_GetVM)(IPB_VM** vm);

    P_PB_GetVM getvm = (P_PB_GetVM)GetProcAddress(hinst,
        "PB_GetVM");
    IPB_VM* pbvm;

    getvm(&pbvm);

    IPB_Session* session = NULL;
    vector<LPCSTR> ll(1);

    ll[0] = "pbrs.pbl";
    pbvm->CreateSession("pbrs", &ll[0], 1, &session);

    pbgroup group = session->FindGroup("n_rs",
        pbgroup_userobject);
    if (group == NULL) return;
    pbclass cls = session->FindClass(group, "n_rs");
    if (cls == NULL) return;
    pbobject obj = session->NewObject(cls);
    if (obj == NULL) return;

    pbmethodID mid = session->GetMethodID(cls, "f_ret",
        PBRT_FUNCTION, "Cresultset.");
    PBCallInfo ci;
    session->InitCallInfo(cls, mid, &ci);
    session->InvokeObjectFunction(obj, mid, &ci);
    // Use the result set returned from f_ret to
    // create an IPB_ResultSetAccessor rsa
    pbobject rs = ci.returnValue->GetObject();
    IPB_ResultSetAccessor* rsa =
        session->GetResultSetAccessor(rs);

    // Create a result set object from rsa
    pbobject rsobj = session->CreateResultSet(rsa);

    // Call the f_in method
    mid = session->GetMethodID(cls, "f_in",
        PBRT_FUNCTION, "IRCresultset.");
    PBCallInfo cil;
    session->InitCallInfo(cls, mid, &cil);
    // Set the result set object rsobj as the
    // argument for f_in
    cil.pArgs->GetAt(0)->SetObject(rsobj);
    session->InvokeObjectFunction(obj, mid, &cil);
}
```



```

    session->FreeCallInfo(&ci);
    session->FreeCallInfo(&ci1);
}

```

f_ret retrieves data from a database into a DataStore and generates a result set:

```

ResultSet rs
DataStore ds

Long sts
Integer li_ret

// Profile Demo Database V170
SQLCA.DBMS = "ODBC"
SQLCA.AutoCommit = False
SQLCA.DBParm = &
    "ConnectionString='DSN=Demo Database V170;UID=dba;PWD=sql'"
connect using sqlca;

ds = Create DataStore
ds.DataObject = ""
ds.DataObject = "d_rs"
ds.SetTransObject(sqlca)
w_main.dw_1.SetTransObject(sqlca)

long ll_ret, rows, rows2
ll_ret = ds.Retrieve()
ll_ret = w_main.dw_1.Retrieve()
//ds.sharedata(w_main.dw_1)
rows = ds.RowCount()
rows2 = w_main.dw_1.RowCount()
messagebox("info from f_ret", " row count is " &
    + string(rows) + " or " + string(rows2))
sts = ds.GenerateResultSet(rs)

Return rs

```

f_in takes a result set, rs, as an argument and uses it to create a DataStore:

```

DataStore ds
Int cnt, li_ret

ds = Create DataStore
ds.CreateFrom(rs)
cnt = ds.RowCount()
messagebox("info from f_in", "row count is " + string(cnt))
Return cnt

```

Usage

To use the IPB_ResultSetAccessor interface, load the PBVM, obtain a result set from a PowerBuilder application, and call GetResultSetAccessor on this result set to get an IPB_ResultSetAccessor interface object. You can then call the methods of this object to get information about the result set. You can also call CreateResultSet using this object as an argument to create a result set that you can return to PowerBuilder.

When you call CreateResultSet, the AddRef function of the IPB_ResultSetAccessor interface is called on the rs argument implicitly to add a reference to the interface pointer.

See also

[AddRef](#)

[GetResultSetAccessor](#)

[IPB ResultSetAccessor interface](#)[ReleaseResultSetAccessor](#)

7.6.8 FindClass

Description

Searches for a class with a given name within a given group.

Syntax

```
FindClass(pbgrou group, LPCTSTR name)
```

Table 7.13:

Argument	Description
group	The handle of the group in which the class resides
name	The class name in lowercase

Return value

pbclass or null on failure.

Examples

This example finds the group associated with the f_getrow function and uses the group to find the class:

```
group = session->FindGroup("f_getrow",
    pbgrou_function);
if ( group==NULL )
    return;
cls = session->FindClass(group, "f_getrow");
if ( cls==NULL )
    return;
```

Usage

This method searches for a PowerBuilder class with the given name in the given group. For example, in a window definition w_1, w_1 is a group, and w_1 and controls contained in it are all classes of group w_1.

See also

[FindGroup](#)

[NewObject](#)

7.6.9 FindClassByClassID

Description

Searches for a class with a given name and a given ID.

Syntax

```
FindClass(pbgrou group, pbint classID)
```

Table 7.14:

Argument	Description
group	The handle of the group in which the class resides
classID	The class name in lowercase

Return value

pbclass or null on failure.

Usage

This method searches for a PowerBuilder class with the given name and the given ID.

See also

[FindGroup](#)

[NewObject](#)

7.6.10 FindGroup**Description**

Searches for a group with a given name and group type in the current library list.

Syntax

```
FindGroup(LPCTSTR name, pbgroup_type type)
```

Table 7.15:

Argument	Description
name	The group name in lowercase
type	An enumerated type defined in pbgroup_type

Return value

pbgroup or null on failure.

Examples

This example finds the group associated with user_exception and uses the group to find the class:

```
group = session-> FindGroup("user_exception",
    pbgroup_userobject);
if ( group==NULL )
    return;
cls = session->FindClass(group, "user_exception")
```

See also

[FindClass](#)

[NewObject](#)

7.6.11 FindMatchingFunction**Description**

Finds a function that has the specified argument list.

Syntax

```
FindMatchingFunction(pbclass cls, LPCTSTR methodName, PBRoutineType rt, LPCTSTR readableSignature)
```

Table 7.16:

Argument	Description
cls	pbclass containing the method.
methodName	The string name of the method in lowercase.
rt	Type of the method: PBRT_FUNCTION for function or PBRT_EVENT for event.
readableSignature	A comma-separated string listing the types of the method's arguments. The return type of the method is not included in the string. See the Usage section for examples.

Return value

pbmethodID.

Examples

This example returns the method ID of a function named uf_test that takes an integer and a double as arguments:

```
pbclass cls;
pbmethodID mid;
PBCallInfo* ci = new PBCallInfo;
unsigned long ret_val;

cls = Session -> GetClass(myobj);
mid = Session -> FindMatchingFunction(cls, "uf_test",
    PBRT_FUNCTION, "int, double");

Session -> InitCallInfo(cls, mid, ci);
```

Usage

FindMatchingFunction provides an alternative to the GetMethodID function. It requires a list of the function's arguments (the readableSignature) instead of the signature obtained using the pbsig170 tool.

This table shows the readableSignature for each of several functions.

Table 7.17: FindMatchingFunction readable signature examples

Function prototype	Signature
void test1()	""
int test2()	""
string test3(int a, double b)	"int, double"
datastore test4(powerobject a[], double b[2 to 10, 1 to 7])	"powerobject[], double[2 to 10, 1 to 7]"

Function prototype	Signature
int test5(readonly int a[10,20], ref long c[])	"readonly int[10,20], ref long[]"

FindMatchingFunction does not check the access type of the function, so you can use it to obtain the method ID of a private function. GetMethodID cannot obtain the method ID of a private function.

See also

[GetMethodID](#)

7.6.12 FreeCallInfo

Description

Frees memory allocated by InitCallInfo.

Syntax

```
FreeCallInfo(PBCallInfo *ci)
```

Table 7.18:

Argument	Description
ci	A pointer to the preallocated PBCallInfo structure

Return value

None.

Examples

FreeCallInfo should be called when the PBCallInfo structure is no longer needed:

```
Session->InvokeObjectFunction(myobj, mid, ci);
ret_val = ci.returnValue->GetInt();
Session->FreeCallInfo(ci);
delete ci;
return ret_val;
```

Usage

This method frees memory allocated by InitCallInfo but does not free the structure ci itself.

See also

[InitCallInfo](#)

7.6.13 Get<type>ArrayItem

Description

Obtains the value of an array item of a specified type.

Syntax

```
GetBlobArrayItem ( pbarray array, pblong dim[ ], pbboolean& IsNull )
```

```

GetBoolArrayItem ( pbarray array, pblong dim[ ], pbboolean& IsNull )
GetByteArrayItem ( pbarray array, pblong dim[ ], pbboolean& IsNull )
GetCharArrayItem ( pbarray array, pblong dim[ ], pbboolean& IsNull )
GetDateArrayItem ( pbarray array, pblong dim[ ], pbboolean& IsNull )
GetDateTimeArrayItem ( pbarray array, pblong dim[ ], pbboolean& IsNull )
GetDecArrayItem ( pbarray array, pblong dim[ ], pbboolean& IsNull )
GetDoubleArrayItem ( pbarray array, pblong dim[ ], pbboolean& IsNull )
GetIntArrayItem ( pbarray array, pblong dim[ ], pbboolean& IsNull )
GetLongArrayItem ( pbarray array, pblong dim[ ], pbboolean& IsNull )
GetLongLongArrayItem (pbarray array, pblonglong dim[ ], pbboolean& IsNull)
GetObjectArrayItem ( pbarray array, pblong dim[ ], pbboolean& IsNull )
GetRealArrayItem ( pbarray array, pblong dim[ ], pbboolean& IsNull )
GetStringArrayItem ( pbarray array, pblong dim[ ], pbboolean& IsNull )
GetTimeArrayItem ( pbarray array, pblong dim[ ], pbboolean& IsNull )
GetUIntArrayItem ( pbarray array, pblong dim[ ], pbboolean& IsNull )
GetUlongArrayItem ( pbarray array, pblong dim[ ], pbboolean& IsNull )

```

Table 7.19:

Argument	Description
array	A valid pbarray structure
dim	The dimension of the array item to be obtained
IsNull	Indicates whether the array item is null

Return value

The value of the array item.

Examples

This example gets the value of an array item of type pbject:

```

pbject      pPObject = NULL;
pbboolean   bIsNull = 0;
pblong      dim[1];

dim[0] = pbl + 1;
pPObject = session->GetObjectArrayItem(array, dim, bIsNull);

```

See also

[GetArrayInfo](#)

[GetArrayItemType](#)

[GetArrayLength](#)

[IsArrayItemNull](#)

[NewBoundedObjectArray](#)

[NewBoundedSimpleArray](#)

[NewUnboundedObjectArray](#)

[NewUnboundedSimpleArray](#)

[ReleaseArrayInfo](#)

[SetArrayItemToNull](#)

[SetArrayItemValue](#)

[Set<type>ArrayItem](#)

7.6.14 Get<type>Field

Description

A set of methods that gets the value of an instance field of an object.

Syntax

```
GetArrayField ( pobject obj, pbfieldID fid, pbboolean& isNull )
GetBlobField ( pobject obj, pbfieldID fid, pbboolean& isNull )
GetBoolField ( pobject obj, pbfieldID fid, pbboolean& isNull )
GetByteField ( pobject obj, pbfieldID fid, pbboolean& isNull )
GetCharField ( pobject obj, pbfieldID fid, pbboolean& isNull )
GetDateField ( pobject obj, pbfieldID fid, pbboolean& isNull )
GetDateTimeField ( pobject obj, pbfieldID fid, pbboolean& isNull )
GetDecField ( pobject obj, pbfieldID fid, pbboolean& isNull )
GetDoubleField ( pobject obj, pbfieldID fid, pbboolean& isNull )
GetIntField ( pobject obj, pbfieldID fid, pbboolean& isNull )
GetLongField( pobject obj, pbfieldID fid, pbboolean& isNull )
GetLongLongField( pobject obj, pbfieldID fid, pbboolean& isNull )
GetObjectField ( pobject obj, pbfieldID fid, pbboolean& isNull )
GetRealField ( pobject obj, pbfieldID fid, pbboolean& isNull )
GetStringField ( pobject obj, pbfieldID fid, pbboolean& isNull )
GetTimeField ( pobject obj, pbfieldID fid, pbint value )
GetUIntField ( pobject obj, pbfieldID fid, pbboolean& isNull )
GetUlongField ( pobject obj, pbfieldID fid, pbboolean& isNull )
```

Table 7.20:

Argument	Description
obj	The handle of the object whose field is to be accessed
fid	The field ID of the specified object
isNull	Indicates whether the field is null

Return value

A predefined PBNI datatype that corresponds to the PowerBuilder datatype in the method name.

Examples

This example gets the value of a field of type pbstring:

```
pbboolean isNull;
pbstring pstr =
    session->GetStringField(proxy, fid, isNull);
if (pstr != NULL)
{
    myclass = session->GetString(pstr);
    // process myclass }
}
```

See also

[GetFieldID](#)[GetFieldType](#)[GetNumOfFields](#)

[IsFieldArray](#)[IsFieldNull](#)[IsFieldObject](#)[SetFieldToNull](#)[Set<type>Field](#)

7.6.15 Get<type>GlobalVar

Description

A set of methods that gets the value of a global variable of a specific datatype.

Syntax

```

GetArrayGlobalVar ( pbfieldID fid, pbboolean& isNull )
GetBlobGlobalVar ( pbfieldID fid, pbboolean& isNull )
GetBoolGlobalVar ( pbfieldID fid, pbboolean& isNull )
GetByteGlobalVar ( pbfieldID fid, pbboolean& isNull )
GetCharGlobalVar ( pbfieldID fid, pbboolean& isNull )
GetDateGlobalVar ( pbfieldID fid, pbboolean& isNull )
GetDateTimeGlobalVar ( pbfieldID fid, pbboolean& isNull )
GetDecGlobalVar ( pbfieldID fid, pbboolean& isNull )
GetDoubleGlobalVar ( pbfieldID fid, pbboolean& isNull )
GetIntGlobalVar ( pbfieldID fid, pbboolean& isNull )
GetLongGlobalVar( pbfieldID fid, pbboolean& isNull )
GetLongLongGlobalVar( pbfieldID fid, pbboolean& isNull )
GetObjectGlobalVar ( pbfieldID fid, pbboolean& isNull )
GetRealGlobalVar ( pbfieldID fid, pbboolean& isNull )
GetStringGlobalVar ( pbfieldID fid, pbboolean& isNull )
GetTimeGlobalVar ( pbfieldID fid, pbint value )
GetUIntGlobalVar ( pbfieldID fid, pbboolean& isNull )
GetUlongGlobalVar ( pbfieldID fid, pbboolean& isNull )

```

Table 7.21:

Argument	Description
fid	The field ID of the global variable
isNull	Indicates whether the variable is null

Return value

A predefined PBNI datatype that corresponds to the PowerBuilder datatype in the method name.

Examples

This code gets the value of a global variable of datatype long using its field ID:

```

fid = session -> GetGlobalVarID("l_gvar");
l_val = session -> GetLongGlobalVar(fid, isNull);
session -> SetLongGlobalVar(fid, l_val + 1);

```

See also

[GetGlobalVarID](#)[GetGlobalVarType](#)

[IsGlobalVarArray](#)[IsGlobalVarNull](#)[IsGlobalVarObject](#)[SetGlobalVarToNull](#)[Set<type>GlobalVar](#)

7.6.16 Get<type>SharedVar

Description

A set of methods that gets the value of a shared variable of a specific datatype.

Syntax

```

GetArraySharedVar ( pbgroup group, pbfieldID fid, pbboolean& isNull )
GetBlobSharedVar ( pbgroup group, pbfieldID fid, pbboolean& isNull )
GetBoolSharedVar ( pbgroup group, pbfieldID fid, pbboolean& isNull )
GetByteSharedVar ( pbgroup group, pbfieldID fid, pbboolean& isNull )
GetCharSharedVar ( pbgroup group, pbfieldID fid, pbboolean& isNull )
GetDateSharedVar ( pbgroup group, pbfieldID fid, pbboolean& isNull )
GetDateTimeSharedVar ( pbgroup group, pbfieldID fid, pbboolean& isNull )
GetDecSharedVar ( pbgroup group, pbfieldID fid, pbboolean& isNull )
GetDoubleSharedVar ( pbgroup group, pbfieldID fid, pbboolean& isNull )
GetIntSharedVar ( pbgroup group, pbfieldID fid, pbboolean& isNull )
GetLongSharedVar( pbgroup group, pbfieldID fid, pbboolean& isNull )
GetLongLongSharedVar( pbgroup group, pbfieldID fid, pbboolean& isNull )
GetObjectSharedVar ( pbgroup group, pbfieldID fid, pbboolean& isNull )
GetRealSharedVar ( pbgroup group, pbfieldID fid, pbboolean& isNull )
GetStringSharedVar ( pbgroup group, pbfieldID fid, pbboolean& isNull )
GetTimeSharedVar ( pbgroup group, pbfieldID fid, pbint value )
GetUintSharedVar ( pbgroup group, pbfieldID fid, pbboolean& isNull )
GetUlongSharedVar ( pbgroup group, pbfieldID fid, pbboolean& isNull )

```

Table 7.22:

Argument	Description
group	The group whose shared variable is to be accessed
fid	The field ID of the shared variable
isNull	Indicates whether the variable is null

Return value

A predefined PBNI datatype that corresponds to the PowerBuilder datatype in the method name.

Examples

This code gets the value of a shared variable of type integer:

```

curGroup = session -> GetCurrGroup();
fid = session -> GetSharedVarID(curGroup, "i_svar");
if (fid == 0xffff)
{
    MessageBox(NULL, "Illegal fid!", "default", MB_OK);
    return;
}

```

```
i_val = session-> GetIntSharedVar(curGroup, fid, isNull);
session-> SetIntSharedVar(curGroup, fid, i_val+1);
```

See also[GetSharedVarID](#)[GetSharedVarType](#)[IsSharedVarArray](#)[IsSharedVarNull](#)[IsSharedVarObject](#)[Set<type>SharedVar](#)[SetSharedVarToNull](#)**7.6.17 GetArrayInfo****Description**

Obtains information about an array.

Syntax

```
GetArrayInfo(pbarray array)
```

Table 7.23:

Argument	Description
array	A valid array handle

Return value

PBArrayInfo*.

Examples

This IF-ELSE statement populates a PBArrayInfo structure if the array in the first value of a PBCallInfo structure is not null:

```
if ( !(ci->pArgs->GetAt(0)->IsNull()) )
{
    array = ci->pArgs->GetAt(0)->GetArray();
    pArrayInfo = session->GetArrayInfo (array);
    pArrayItemCount = session->GetArrayLength(array);
}
else
{
    // NULL array
    pArrayItemCount = 0;
}
```

Usage

If the array is an unbounded array, the bounds information in PBArrayInfo is undetermined. The returned PBArrayInfo must be freed later by ReleaseArrayInfo.

See also[Get<type>ArrayItem](#)

[GetArrayType](#)[GetArrayLength](#)[IsArrayItemNull](#)[NewBoundedObjectArray](#)[NewBoundedSimpleArray](#)[NewUnboundedObjectArray](#)[NewUnboundedSimpleArray](#)[ReleaseArrayInfo](#)[SetArrayItemToNull](#)[SetArrayItemValue](#)[Set<type>ArrayItem](#)

7.6.18 GetArrayType

Description

Obtains the datatype of an item in an array.

Syntax

```
GetArrayType( parray array, pblong dim[ ] )
```

Table 7.24:

Argument	Description
array	A valid parray structure.
dim	A pblong array to hold the indexes of each dimension of the array. The size of the array must equal the dimensions of array.

Return value

pbuint.

See also

[Get<type>ArrayItem](#)[GetArrayInfo](#)[GetArrayLength](#)[IsArrayItemNull](#)[NewBoundedObjectArray](#)[NewBoundedSimpleArray](#)[NewUnboundedObjectArray](#)[NewUnboundedSimpleArray](#)[ReleaseArrayInfo](#)

[SetArrayItemToNull](#)[SetArrayItemValue](#)[Set<type>ArrayItem](#)

7.6.19 GetArrayLength

Description

Obtains the length of an array.

Syntax

```
GetArrayLength(pbarray array)
```

Table 7.25:

Argument	Description
array	A valid array handle

Return value

pblong.

Examples

This IF-ELSE statement populates a PBArryInfo structure. If the array in the first value of a PBCallInfo structure is not null, it sets the value of the pArrayItemCount variable to the length of the array:

```
if ( !(ci->pArgs->GetAt(0)->IsNull()) )
{
    array = ci->pArgs->GetAt(0)->GetArray();
    pArrayInfo = session->GetArrayInfo (array);
    pArrayItemCount = session->GetArrayLength(array);
}
else
{
    // NULL array
    pArrayItemCount = 0;
}
```

See also

[Get<type>ArrayItem](#)[GetArrayInfo](#)[IsArrayItemNull](#)[NewBoundedObjectArray](#)[NewBoundedSimpleArray](#)[NewUnboundedObjectArray](#)[NewBoundedSimpleArray](#)[ReleaseArrayInfo](#)[SetArrayItemToNull](#)[SetArrayItemValue](#)

[Set<type>ArrayItem](#)

7.6.20 GetBlob

Description

Returns a pointer to the data buffer for a blob.

Syntax

```
GetBlob(pblob bin)
```

Table 7.26:

Argument	Description
bin	A pointer to the source buffer

Return value

void*.

Examples

In this CASE clause, the value returned from GetBlob is cast to the LPCTSTR variable pStr. If it is not null, the return value in the PBCallInfo structure is set to the value of the blob:

```
case pbvalue_blob:
    pStr = (LPCTSTR)Session-> GetBlob(retVal.blob_val);
    if (strcmp(pStr, "null", 4)==0 )
        ci -> returnValue ->SetToNull();
    else
    {
        ci -> returnValue->SetBlob(retVal.blob_val);
        Session -> ReleaseValue(retVal);
    }
    break;
```

See also

[GetBlobLength](#)

[NewBlob](#)

[SetBlob](#)

7.6.21 GetBlobLength

Description

Returns the length in bytes of blob data in a buffer.

Syntax

```
GetBlobLength (pblob bin)
```

Table 7.27:

Argument	Description
bin	A pointer to the source buffer

Return value

pblong.

Examples

In this example, the IPB_Value GetBlob function is used to get a blob value from the PBCallInfo structure. The length of the blob is used as an argument to the NewBlob function:

```
PBCallInfo* ci = new PBCallInfo;
pbblob ret_val;
pblong bloblen;

ret_val = ci.returnValue-> GetBlob();
bloblen = Session-> GetBlobLength(ret_val);
ret_val = Session-> NewBlob (Session->GetBlob(ret_val), bloblen);
```

See also

[GetBlob](#)

[NewBlob](#)

[SetBlob](#)

7.6.22 GetClass

Description

Returns the class handle of a PowerBuilder object. This function is most frequently used to obtain a class handle for use with the GetMethodID function.

Syntax

```
GetClass (pbject obj)
```

Table 7.28:

Argument	Description
obj	A valid PowerBuilder object handle

Return value

pbclass or null on error.

Examples

In this example, GetClass is used to obtain the class of a variable of type UserData so that the class can be used as an argument to the GetMethodID function:

```
BOOL CALLBACK CFontEnumerator::EnumFontProc
(
    LPLOGFONT lplf,
    LPNEWTEXTMETRIC lpntm,
    DWORD FontType,
    LPVOID userData
)
{
    UserData* ud = (UserData*)userData;
    pbclass clz = ud->session->GetClass(ud->object);
    pbmethodID mid = ud->session->GetMethodID
        (clz, "onnewfont", PBRT_EVENT, "IS");

    PBCallInfo ci;
```

```

ud->session->InitCallInfo(clz, mid, &ci);

pbstring str = ud->session->NewString
    (lpplf->lfFaceName);
ci.pArgs->GetAt(0)->SetPBString(str);
ud->session->TriggerEvent(ud->object, mid, &ci);
pbint ret = ci.returnValue->GetInt();
ud->session->FreeCallInfo(&ci);

return ret == 1    TRUE : FALSE;
}

```

See also[GetClassName](#)[GetMethodID](#)**7.6.23 GetClassName****Description**

Returns the name of a class in lowercase.

Syntax

```
GetClassName(pbclass cls)
```

Table 7.29:

Argument	Description
cls	A valid class handle

Return value

LPCTSTR.

Examples

This example gets the name of a class and sets the size of the variable stLength to the length of the returned string plus 1:

```

LPCTSTR myClassName = session->GetClassName( myClass );
size_t stLength = strlen( (LPCTSTR)myClassName ) + 1;

```

Usage

When you have finished using the name, call the ReleaseString method to free the memory acquired.

See also[GetClass](#)[ReleaseString](#)**7.6.24 GetCurrGroup****Description**

Obtains the name of the current group.

Syntax

```
GetCurrGroup( )
```

Return value

pbgroup or null on failure.

Examples

This example gets the name of the current group and uses it to obtain the identifier of a shared variable, get the shared variable's value, and reset the shared variable's value:

```
curGroup = session -> GetCurrGroup();
fid = session -> GetSharedVarID(curGroup, "i_svar");
if (fid == 0xffff)
{
    MessageBox(NULL, "Illegal fid!", "default", MB_OK);
    return;
}
i_val = session-> GetIntSharedVar(curGroup, fid, isNull);
session-> SetIntSharedVar(curGroup, fid, i_val+1);
```

See also

[Get<type>SharedVar](#)

[GetSharedVarID](#)

[Set<type>SharedVar](#)

7.6.25 GetDateString

Description

Converts data in a pbdate object to a string.

Syntax

```
GetDateString(pbdate date)
```

Table 7.30:

Argument	Description
date	The pbdate data object to be converted to a string.

Return value

LPCTSTR.

See also

[NewDate](#)

[ReleaseDateString](#)

[SetDate](#)

7.6.26 GetDateTimeString

Description

Converts data in a pbdatetime object to a string.

Syntax

```
GetDateTimeString(pbdatetime datetime)
```

Table 7.31:

Argument	Description
datetime	The pbdatetime data object to be converted to a string.

Return value

LPCTSTR.

See also

[NewDateTime](#)

[ReleaseDateTimeString](#)

[SetDateTime](#)

7.6.27 GetDecimalString

Description

Converts decimal data in a pbdec object to a string.

Syntax

```
GetDecimalString(pbdec dec)
```

Table 7.32:

Argument	Description
dec	The pbdec data object to be converted to a string.

Return value

LPCTSTR.

Examples

This code checks whether a value in the PBCallInfo structure is null. If it is not, it sets the value in the pArguments array to the value in PBCallInfo:

```
case pbvalue_dec:
if (ci->pArgs->GetAt(i)->IsNull())
{
    pArguments[i].dec_val = Session->NewDecimal();
    Session->SetDecimal(pArguments[i].dec_val, "1.0");
}
else
    pArguments[i].dec_val =
        ci->pArgs->GetAt(i)->GetDecimalString();
break;
```

See also[NewDecimal](#)[ReleaseDecimalString](#)[SetDecimal](#)**7.6.28 GetEnumItemName****Description**

Obtains the name of an enumerated variable.

Syntax

```
GetEnumItemName(LPCTSTR enumName, long enumItemValue)
```

Return value

LPCTSTR.

Usage

When you have finished using the name, call the `ReleaseString` method to free the memory acquired.

See also[GetEnumItemValue](#)[ReleaseString](#)**7.6.29 GetEnumItemValue****Description**

Obtains the value of an enumerated variable.

Syntax

```
GetEnumItemValue(LPCTSTR enumName, LPCTSTR enumItemName)
```

Return value

Long.

Examples

This example gets the numeric value for the `boolean!` enumerated value, then uses it to return the string value:

```
pblong lType = session->GetEnumItemValue("object",  
    boolean" ); // returns 138  
LPCTSTR szEnum = session->GetEnumItemName( "object",  
    lType ); // returns "boolean"
```

Usage

`GetEnumItemValue` and `GetEnumItemName` support enumerated types. They allow you to convert the name of an enumerated value, a string with an appended exclamation mark (!), to an integer value, and vice versa.

The ! character must be omitted

When you use these functions, the enumItemName should not use the appended exclamation mark (!) character.

To return an enumerated value from an extension to PowerScript, you must use the SetLong function to set the value of the enumerated variable into IPB_Value. Using SetInt or SetShort fails. However, you can use GetInt or GetShort as well as GetLong to obtain the enumerated variable's value, assuming the value is in the appropriate range. For example, if you attempt to use GetInt to obtain a value that is more than 32767, the returned value is truncated.

See also

[GetEnumItemName](#)

7.6.30 GetException

Description

Obtains the current thrown exception object.

Syntax

```
GetException ()
```

Return value

pbobject.

Examples

This code gets the current exception object, clears the exception, and gets the class of the exception object:

```
pbclass cls;
pbobject ex;
...
ex = session-> GetException();
session-> ClearException();
cls = session-> GetClass(ex);
```

See also

[ClearException](#)

[HasExceptionThrown](#)

7.6.31 GetFieldID

Description

Obtains the internal ID of a class instance variable.

Syntax

```
GetFieldID(pbclass cls, LPCTSTR fieldName)
```

Table 7.33:

Argument	Description
cls	The class in which the field resides

Argument	Description
fieldName	The instance member name, in lowercase

Return value

pbfieldID or 0xffff if a field ID cannot be found.

Examples

This function obtains the identifier of a class's visible field, if it exists, and uses it to set the value of the field:

```
void CallBack::f_setvisible(IPB_Session* session,
    pobject dwobj)
{
    pbclass cls;
    IPB_Value* pv;
    pbfieldID fid;
    pbstring strtmp;
    bool isTrue;
    pbboolean isNull;

    cls = session-> GetClass(dwobj);
    fid = session-> GetFieldID(cls, "visible");
    if (fid == kUndefinedFieldID)
        return;
    isTrue = session-> GetBoolField(dwobj, fid, isNull);
    if (isTrue)
        session -> SetBoolField(dwobj, fid, false);
    else
        session -> SetBoolField(dwobj, fid, true);
    return ;
}
```

Usage

GetFieldID is one of a set of functions that allows native code to access the fields of Java objects and get and set their values. You use GetFieldID to retrieve the value of a field, specifying the class name and the field name. The field ID returned can be used as an argument to the related functions.

See also

[GetFieldType](#)

[Get<type>Field](#)

[GetNumOfFields](#)

[IsFieldArray](#)

[IsFieldNull](#)

[IsFieldObject](#)

[Set<type>Field](#)

[SetFieldToNull](#)

7.6.32 GetFieldName

Description

Obtains the name of the specified field.

Syntax

```
GetFieldName(pbclass cls, pbfieldID fid)
```

Table 7.34:

Argument	Description
cls	The class that defines the field
fid	The internal ID of the class instance variable

Return value

LPCTSTR.

The field name of the specified field. If an incorrect field ID is specified, this function returns null.

Usage

When you have finished using the name, call the `ReleaseString` method to free the memory acquired.

See also

[GetFieldID](#)

[ReleaseString](#)

7.6.33 GetFieldType

Description

Obtains the datatype of a field declared by a class.

Syntax

```
GetFieldType(pbclass cls, pbfieldID fid)
```

Table 7.35:

Argument	Description
cls	The class that defines the field
fid	The internal ID of the class instance variable

Return value

pbint.

A simple datatype defined in the list of `pbvalue_type` enumerated types, such as `pbvalue_int`. See [PBNI enumerated types](#).

Examples

This statement gets the type of the specified field ID:

```
pbint pbfieldType = session->GetFieldType(cls, fid);
```

See also

[GetFieldID](#)[Get<type>Field](#)[GetNumOfFields](#)[IsFieldArray](#)[IsFieldNull](#)[IsFieldObject](#)[Set<type>Field](#)[SetFieldToNull](#)

7.6.34 GetGlobalVarID

Description

Returns the internal ID of a global variable.

Syntax

```
GetGlobalVarID(LPCTSTR name)
```

Table 7.36:

Argument	Description
name	The name of the global variable in lowercase

Return value

pbfieldID or null on failure.

Examples

This example gets the internal identifier of a long variable and uses it to get and set a global variable:

```
fid = session -> GetGlobalVarID("l_gvar");
l_val = session -> GetLongGlobalVar(fid, isNull);
session -> SetLongGlobalVar(fid, l_val + 1);
```

See also

[GetGlobalVarType](#)[Get<type>GlobalVar](#)[IsGlobalVarArray](#)[IsGlobalVarNull](#)[IsGlobalVarObject](#)[SetGlobalVarToNull](#)[Set<type>GlobalVar](#)

7.6.35 GetGlobalVarType

Description

Obtains the datatype of a global variable.

Syntax

```
GetGlobalVarType(pbfieldID fid)
```

Table 7.37:

Argument	Description
fid	The internal ID of the class instance variable

Return value

pbuint.

A simple datatype defined in the list of pbvalue_type enumerated types.

Examples

This code tests getting and setting a global integer variable using the field ID fid:

```
fid = session -> GetGlobalVarID("i_gvar");
if (session -> GetGlobalVarType(fid) == pbvalue_int)
{
    i_val=session -> GetIntGlobalVar(fid,isNull);
    session -> SetIntGlobalVar(fid,i_val+1);
}
```

See also

[GetGlobalVarID](#)

[Get<type>GlobalVar](#)

[IsGlobalVarArray](#)

[IsGlobalVarNull](#)

[IsGlobalVarObject](#)

[SetGlobalVarToNull](#)

[Set<type>GlobalVar](#)

7.6.36 GetMarshaler

Description

Obtains the marshaler object associated with a proxy object.

Syntax

```
GetMarshaler(pbproxyObject obj)
```

Table 7.38:

Argument	Description
obj	An object of type pbproxyObject for which you want to find the marshaler.

Return value

IPBX_Marshaler*.

Examples

This code creates a Java marshaler object and associates it with a proxy. Later, GetMarshaler is used to get the marshaler object:

```
// Create JavaMarshaler
JavaMarshaler* marshaler = new JavaMarshaler(env,
    proxy, jobj);

// Associate the JavaMarshaler with the
// PowerBuilder proxy
session-> SetMarshaler(proxy, marshaler);

ci-> pArgs-> GetAt(0)-> SetObject(proxy);

ci-> returnValue-> SetLong(kSuccessful);

return PBX_OK;
...
// Get the marshaler
IPBX_Marshaler* pIPBX_Marshaler = NULL;

pIPBX_Marshaler =(IPBX_Marshaler*)session
-> GetMarshaler(proxy);
```

See also

[SetMarshaler](#)

7.6.37 GetMethodID

Description

Returns the ID of the requested method.

Syntax

```
GetMethodID(pbclass cls, LPCTSTR methodName, PBRoutineType rt, LPCTSTR signature,
    pbboolean publicOnly)
```

Table 7.39:

Argument	Description
cls	pbclass containing the function.
methodName	The string name of the method in lowercase.
rt	Type of the method: PBRT_FUNCTION for function or PBRT_EVENT for event.
signature	Internal signature of the PowerBuilder function, used to identify polymorphic methods in one class. Obtained with the pbsig170 tool. If the signature is a null string (" "), the first method found with the name methodName is returned.
publicOnly	A boolean that determines whether only public methods are searched (true) or all

Argument	Description
	methods are searched (false). The default is true.

Return value

pbMethodID of the method or kUndefinedMethodID on error.

Examples

This function uses GetMethodID to obtain the identifier (mid) of the onnewfont function so that the identifier can be used to initialize the PBCallInfo structure and call the function:

```

BOOL CALLBACK CFontEnumerator::EnumFontProc
(
    LPLOGFONT lplf,
    LPNEWTEXTMETRIC lpntm,
    DWORD FontType,
    LPVOID userData
)
{
    UserData* ud = (UserData*)userData;
    pbclass clz = ud->session->GetClass(ud->object);
    pbmethodID mid = ud->session->GetMethodID(clz,
        "onnewfont", PBRT_EVENT, "IS");

    PBCallInfo ci;
    ud->session->InitCallInfo(clz, mid, &ci);
    pbstring str = ud->session->
        NewString(lplf->lfFaceName);
    ci.pArgs->GetAt(0)->SetPBString(str);
    ud->session->TriggerEvent(ud->object, mid, &ci);
    pbint ret = ci.returnValue->GetInt();
    ud->session->FreeCallInfo(&ci);

    return ret == 1    TRUE : FALSE;
}

```

Usage

The GetMethodID function is used to obtain the ID of a method so you can use it to invoke functions and trigger events.

See also

[FindMatchingFunction](#)

[InvokeObjectFunction](#)

[TriggerEvent](#)

[Calling PowerScript from an extension](#)

7.6.38 GetMethodIDByEventID

Description

Returns the ID of the method that has a given predefined PowerBuilder event ID.

Syntax

```
GetMethodIDByEventID(pbclass cls, LPCTSTR eventID)
```

Table 7.40:

Argument	Description
cls	pbclass containing the method
eventID	A PowerBuilder predefined event string, such as pbm_bnclicked

Return value

pbMethodID of the method or kUndefinedMethodID on error.

Examples

This statement obtains the ID of the event identified by the name pbm_lbuttonup:

```
pbmethodID mid = d_session->GetMethodIDByEventID(cls,
    "pbm_lbuttonup");
```

See also

[GetMethodID](#)

7.6.39 GetNativeInterface**Description**

Obtains a pointer to the interface of a native class.

Syntax

```
GetNativeInterface(pbobject obj)
```

Table 7.41:

Argument	Description
obj	A valid object handle

Return value

IPBX_UserObject.

Examples

This example invokes the function f_retrieve in the native class Cmy_pbni to retrieve a DataWindow object:

```
long f_retrieve(IPB_Session* session, pbint iarg,
    pbobject dwObj, pbobject extObj)
{
    Imy_pbni* pImy_pbni = NULL;
    pblong lRet;
    if (session -> IsNativeObject(extObj) )
    {
        pImy_pbni = (Imy_pbni*) session ->
            GetNativeInterface(extObj);

        lRet = pImy_pbni-> f_Retrieve(session,
            iarg, dwObj);
    }
    return lRet;
}
```

}

Usage

Use this method in conjunction with `IsNativeObject` to obtain a direct reference to the `IPBX_UserObject` associated with a native class in the same PowerBuilder extension. The class and its methods can then be accessed directly.

See also

[IsNativeObject](#)

7.6.40 GetNumOfFields**Description**

Returns the number of fields in the specified class.

Syntax

```
GetNumOfFields(pbclass cls)
```

Table 7.42:

Argument	Description
cls	A valid class handle for the class whose field is to be accessed

Return value

pbulong.

Examples

This code gets the numbers of fields in the class `clz`:

```
pbclass clz = d_session->GetClass(d_pbobj);
pbulong nf = d_session->GetNumOfFields(clz);
```

See also

[GetFieldID](#)

[Get<type>Field](#)

[IsFieldArray](#)

[IsFieldNull](#)

[IsFieldObject](#)

[SetFieldToNull](#)

[Set<type>Field](#)

7.6.41 GetPBAnyArrayItem**Description**

Obtains the value of a global variable of type `Any`.

Syntax

```
GetPBAnyArrayItem( pbararray array, pblong dim[], pbboolean& isNull )
```

Table 7.43:

Argument	Description
array	A valid pbararray structure.
dim	A pblong array to hold the indexes of each dimension of the array. The size of the array must equal the dimensions of array.
isNull	Indicates whether the variable is null

Return value

IPB_Value*.

Usage

See [GetPBAnyField](#).

See also

[GetPBAnyField](#)

[GetPBAnyGlobalVar](#)

[GetPBAnySharedVar](#)

7.6.42 GetPBAnyField**Description**

Obtains the value of a variable of type Any.

Syntax

```
GetPBAnyField( pbject obj, pfieldID fid, pbboolean& isNull )
```

Table 7.44:

Argument	Description
obj	A valid object handle for the object whose value is to be obtained
fid	The field ID of the variable
isNull	Indicates whether the variable is null

Return value

IPB_Value*.

Examples

This example tests all the functions used to get the value of variables of type Any, using PushLocalFrame and PopLocalFrame to simulate the scope of a function call:

```
session->PushLocalFrame();
pbggroup vgroup = session->FindGroup("n_test",
    pbgroup_userobject);
pbclass vcls = session->FindClass(vgroup, "n_test");
```

```

pbobject vobj = session->NewObject(vcls);
pbboolean isNull;

pbfieldID vfid = session->GetFieldID(vcls, "i_a");
IPB_Value* value = session->GetPBAnyField(vobj,
    vfid, isNull);
pbstring str = value->GetString(); // save actual value

vfid = session->GetSharedVarID(vgroup, "s_a");
value = session->GetPBAnySharedVar(vgroup,
    vfid, isNull);
//Get the actual value here.

vfid = session->GetGlobalVarID("g_a");
value = session->GetPBAnyGlobalVar(vfid, isNull);
//Get the actual value here.

vfid = session->GetFieldID(vcls, "i_array");
pbarray arr = session->GetArrayField(vobj,
    vfid, isNull); //Get the any array first.

long dim = 1;
value = session->GetPBAnyArrayItem(arr, &dim, isNull);
//Get the actual value here.
session->PopLocalFrame();

```

Usage

The value you retrieve must be of datatype Any to use this function; that is, the variable associated with the function must be declared as a variable of type Any in the development environment. If it is not, the function returns a null pointer and the value of isNull is set to true.

This function returns a pointer to an IPB_Value instance. When it is called, memory is allocated for the returned IPB_Value instance, and the pointer is recorded in the current local frame. The pointer is deleted automatically when the current local frame is popped, which occurs when the current local function returns (you can also call PopLocalFrame to force the frame to be popped).

If you want to use the value returned, you must save the value pointed to by the IPB_Value instance (not the IPB_Value instance itself) before the frame is popped. If you save the pointer itself, the value is only valid until the original value is destroyed.

You can use the AcquireValue function to save the value, or one of the IPB_Value Get<type> functions. For example, the following code saves the string value in the IPB_Value instance ivalue into the string str. The value in str can be used after the local frame is popped and ivalue is deleted:

```

IPB_Value* ivalue = session->GetPBAnyField(vobj, vfid,
    isNull);
pbstring str = ivalue->GetString();

```

If you do not know the actual datatype of the Any variable, use the IPB_Value GetType function to get its datatype first, then use the appropriate get function to get its value.

IPB_Value holds a reference to the original value

The value in the IPB_Value instance is a reference to the original value. If you change the actual value of the returned IPB_Value, the original value is also changed. If you

use the `AcquireValue` function to save the value, it clones a new `IPB_Value` and resets the existing `IPB_Value` pointer.

See also

[GetPBAnyArrayItem](#)

[GetPBAnyGlobalVar](#)

[GetPBAnySharedVar](#)

7.6.43 GetPBAnyGlobalVar

Description

Obtains the value of a global variable of type Any.

Syntax

```
GetPBAnyGlobalVar( pbfieldID fid, pbboolean& isNull )
```

Table 7.45:

Argument	Description
fid	The field ID of the variable
isNull	Indicates whether the variable is null

Return value

`IPB_Value*`.

Usage

See [GetPBAnyField](#).

See also

[GetPBAnyArrayItem](#)

[GetPBAnyField](#)

[GetPBAnySharedVar](#)

7.6.44 GetPBAnySharedVar

Description

Obtains the value of a shared variable of type Any.

Syntax

```
GetPBAnySharedVar( pbgroup group, pbfieldID fid, pbboolean& isNull )
```

Table 7.46:

Argument	Description
group	The group to which the variable belongs
fid	The field ID of the variable

Argument	Description
isNull	Indicates whether the variable is null

Return value

IPB_Value*.

Usage

See [GetPBAnyField](#).

See also

[GetPBAnyArrayItem](#)

[GetPBAnyField](#)

[GetPBAnyGlobalVar](#)

7.6.45 GetProp**Description**

Retrieves a pointer to the data value of a variable that has been registered as a shared property for the current IPB session.

Syntax

```
GetProp(LPCTSTR name)
```

Table 7.47:

Argument	Description
name	The name of the variable whose value is to be retrieved.

Return value

Void*. If the variable does not exist, returns null.

Examples

See [SetProp](#).

Usage

The variable's name must first be registered with the session using the SetProp function.

See also

[RemoveProp](#)

[SetProp](#)

7.6.46 GetResultSetAccessor**Description**

Obtains an interface through which you can read data from a result set.

Syntax

```
GetResultSetAccessor (pobject rs)
```

Table 7.48:

Argument	Description
rs	A pobject holding a result set obtained using CreateResultSet

Return value

IPB_ResultSetAccessor

Examples

This example gets a result set, rs, from the return value of a PowerScript function and uses it to create an IPB_ResultSetAccessor object, rsa:

```
pobject rs = ci.returnValue->GetObject();
IPB_ResultSetAccessor* rsa =
    session->GetResultSetAccessor(rs);
```

See also

[CreateResultSet](#)

[ReleaseResultSetAccessor](#)

7.6.47 GetSharedVarID

Description

Returns the internal ID of a shared variable.

Syntax

```
GetSharedVarID(pbgroup group, LPCTSTR fieldname)
```

Table 7.49:

Argument	Description
group	The group to which the shared variable belongs
fieldname	The name of the field that contains the shared variable, in lowercase

Return value

pbfieldID.

Returns 0xffff if the ID cannot be found.

Examples

This code uses GetSharedVarID to obtain the field ID of a shared variable, then uses that ID to obtain the value of the variable:

```
curGroup = session -> GetCurrGroup();
```



```

fid = session -> GetSharedVarID(curGroup, "i_svar");
if (fid == 0xffff)
{
    MessageBox(NULL, "Illegal fid!", "default", MB_OK);
    return;
}
i_val = session -> GetIntSharedVar(curGroup, fid,
    isNull);

```

See also[Get<type>SharedVar](#)[GetSharedVarType](#)[IsSharedVarArray](#)[IsSharedVarNull](#)[IsSharedVarObject](#)[Set<type>SharedVar](#)[SetSharedVarToNull](#)**7.6.48 GetSharedVarType****Description**

Obtains the datatype of the specified shared variable.

Syntax

```
GetSharedVarType ( pbgroup group, pbfieldID fid )
```

Table 7.50:

Argument	Description
group	The group to which the shared variable belongs
fid	The internal field ID of the shared variable

Return value

pbuint.

A simple datatype defined in the list of pbvalue_type enumerated types.

Examples

This example gets the field ID of a shared variable, then uses that ID to get the type of the shared variable:

```

pbuint pbvaltype;
curGroup = session -> GetCurrGroup();
fid = session -> GetSharedVarID(curGroup, "i_svar");
pbvaltype = session -> GetSharedVarType(curGroup, fid);

```

See also[Get<type>SharedVar](#)

[GetSharedVarID](#)[IsSharedVarArray](#)[IsSharedVarNull](#)[IsSharedVarObject](#)[Set<type>SharedVar](#)[SetSharedVarToNull](#)

7.6.49 GetString

Description

Returns a pointer to the string passed in as an argument.

Syntax

```
GetString (pbstring* string)
```

Table 7.51:

Argument	Description
string	A pointer to a pbstring

Return value

LPCTSTR.

Examples

This example uses the IPB_Value GetString function to obtain a string value from the PBCallInfo structure. If the string is not null, the IPB_Session GetString function sets the value of the proxyname string to a pointer to the returned value:

```
string proxyName;
{
    pbstring pn = ci->pArgs->GetAt(2)->GetString();

    if (pn == NULL)
    {
        ci->returnValue->SetLong(kInvalidProxyName);
        return PBX_OK;
    }
    else
    {
        proxyName = session->GetString(pn);
    }
}
```

Usage

When you have finished using the string, call the ReleaseString method to free the memory acquired.

See also

[GetStringLength](#)[NewString](#)

[ReleaseString](#)[SetString](#)

7.6.50 GetStringLength

Description

Returns the length of a string in bytes without the terminator.

Syntax

```
GetStringLength (pbstring string)
```

Table 7.52:

Argument	Description
string	The pbstring whose length is to be determined

Return value

pblong.

Examples

These statements set the value of a pblong variable to the length of a string:

```
pblong long_val;
pbstring str_val;
long_val = session-> GetStringLength( str_val );
```

See also

[GetString](#)[NewString](#)[SetString](#)

7.6.51 GetSuperClass

Description

Returns the ancestor class of the specified class, if any.

Syntax

```
GetSuperClass(pbclass cls)
```

Table 7.53:

Argument	Description
cls	A valid class handle for the descendant class

Return value

pbclass or 0 if the class has no ancestor.

Examples

These statements get the class of an object in the PBCallInfo structure, the ancestor class of that class, and then the name of the ancestor class:

```
pbclass cls, cls_parent;
LPCSTR clsname;

cls = Session-> GetClass(ci-> pArgs-> GetAt(0)->
    GetObject());
cls_parent = Session-> GetSuperClass(cls);
clsname = Session-> GetClassName(cls_parent);
```

See also

[GetClass](#)

[GetClassName](#)

7.6.52 GetSystemClass

Description

Returns the first system class that the input class inherits from.

Syntax

```
GetSystemClass (pbclass cls)
```

Table 7.54:

Argument	Description
cls	A descendant class whose ancestor system class is to be determined

Return value

pbclass or null on error.

See also

[GetMethodID](#)

[GetSystemGroup](#)

7.6.53 GetSystemGroup

Description

Returns a PowerBuilder internal system group.

Syntax

```
GetSystemGroup()
```

Return value

pbclass or null on error.

Usage

GetSystemGroup returns the PowerBuilder internal system group, which contains all the system types such as PowerObject, NonVisualObject, Structure, Window, CommandButton,

and so on. You can use this system group to obtain a system class. You might need to call PowerScript functions in the PowerBuilder extension. To achieve this, you first need to get the pbclass that the PowerScript function class resides in. This code gets the PowerBuilder system function class:

```
pbgroup sysGroup = session->GetSystemGroup();
pbclass sysFuncClass = session->FindClass(sysGroup,
    "SystemFunctions");
```

After you get the system class, you can obtain the method ID of a PowerScript function by calling FindMatchingFunction, and then you can invoke the PowerScript function.

See also

[FindMatchingFunction](#)

[GetSystemClass](#)

7.6.54 GetTimeString

Description

Converts data in a pbtime object to a string.

Syntax

```
GetTimeString(pbtime time)
```

Table 7.55:

Argument	Description
time	The pbtime data object to be converted to a string.

Return value

LPCTSTR.

See also

[NewString](#)

[ReleaseTimeString](#)

[SetString](#)

7.6.55 HasExceptionThrown

Description

Checks for the existence of an exception that has been thrown but not cleared.

Syntax

```
HasExceptionThrown()
```

Return value

pbboolean.

Returns true if a PowerBuilder exception has been thrown but not cleared.

Examples

This example tests whether an exception has been thrown so it can be handled and cleared:

```
try
{
    session->InvokeObjectFunction(pbobj, mid, &ci);
    // Was PB exception thrown
    if (session-> HasExceptionThrown())
    {
        // Handle PB exception
        session-> ClearException();
    }
}
```

See also

[ClearException](#)

[GetException](#)

[ThrowException](#)

7.6.56 HasPBVisualObject

Description

Determines whether any PowerBuilder windows, visible or hidden, are still in existence.

Syntax

```
HasPBVisualObject()
```

Return value

pbboolean.

Returns true if any PowerBuilder windows are still alive. If any windows that are not response windows are still alive, the PowerBuilder application returns immediately unless you manually add a message loop.

Examples

This example is similar to the example for `RestartRequested`, but it includes a call to `HasPBVisualObject` that opens a message loop if the return value is true:

```
PBXRESULT  PB_MyWinAppRunner::RunApplication()
{
    PBXRESULT res;
    pbboolean restart = FALSE;

    do    {
        res = StartApplication();
        if (res == PBX_OK)
            // Process message dispatch
            {
                if ( GetSession()->HasPBVisualObject() )
                {
                    MSG msg;
                    while ( GetMessage(&msg, 0, 0, 0) )
                    {
                        TranslateMessage(&msg);
                    }
                }
            }
    }
}
```

```

        DispatchMessage(&msg);

        if ( !GetSession()->HasPBVisualObject() )
            break;
    }
}
else
    break;

restart = GetSession()->RestartRequested();
if (restart)
    RecreateSession();
} while (restart);

return CleanApplication();
}

```

Usage

RestartRequested and HasVisualPBObject are used in the implementation of the IPB_VM RunApplication function. You no longer need to use an external message loop to check for Windows messages when you call the RunApplication function as you did in versions of PBNI prior to PowerBuilder 10.5.

See also

[RestartRequested](#)

[RunApplication](#)

7.6.57 InitCallInfo

Description

Initializes the PBCallInfo structure.

Syntax

```
InitCallInfo(pbclass cls, pbmethodID mid, PBCallInfo *ci)
```

Table 7.56:

Argument	Description
cls	The pbclass containing the method
mid	The pbMethodID returned by GetMethodID
ci	A pointer to a preallocated PBCallInfo structure

Return value

PBXRESULT. Returns PBX_OK on success, and PBX_E_INVALID_ARGUMENT on failure.

Examples

This example shows the implementation of a TriggerEvent function in a visual class. It takes an event name as an argument, obtains the class and method ID needed to initialize the PBCallInfo structure, triggers the event, and frees the PBCallInfo structure:

```

void CVisualExt::TriggerEvent(LPCTSTR eventName)
{
    pbclass clz = d_session->GetClass(d_pbobj);
    pbmethodID mid = d_session->GetMethodID(clz,
        eventName, PBRT_EVENT, "I");

    PBCallInfo ci;
    d_session->InitCallInfo(clz, mid, &ci);
    d_session->TriggerEvent(d_pbobj, mid, &ci);
    d_session->FreeCallInfo(&ci);
}

```

Usage

On return, this method allocates enough space for the arguments, and then initializes the arguments and return value. You must set appropriate values in the PBCallInfo structure. Note that the structure itself must have been allocated before the call.

See also

[FreeCallInfo](#)

7.6.58 InvokeClassFunction

Description

Invokes system or user global functions.

Syntax

```
InvokeClassFunction(pbclass cls, pbmethodID mid, PBCallInfo *ci)
```

Table 7.57:

Argument	Description
cls	The class that contains the global function. If this is a system function, cls is obtained with GetSystemFunctionsClass; otherwise, it is obtained with FindGroup and FindClass, with the function name as the group/class name.
mid	The pbMethodID returned by GetMethodID.
ci	A pointer to a preallocated PBCallInfo structure.

Return value

PBXRESULT. Returns PBX_OK for success, or one of the following for failure:

PBX_E_INVALID_ARGUMENT

PBX_E_INVOKE_METHOD_INACCESSABLE

PBX_E_INVOKE_WRONG_NUM_ARGS

PBX_E_INVOKE_REFARG_ERROR

PBX_E_INVOKE_METHOD_AMBIGUOUS

PBX_E_INVOKE_FAILURE

PBX_E_INVOKE_FAILURE

Examples

This example gets the PowerBuilder system class and uses it to invoke the double function:

```

cls = session-> GetSystemClass();
mid = session-> GetMethodID (cls, "double", PBRT_FUNCTION, "DA");
session-> InitCallInfo(cls, mid, ci);
ci->pArgs -> GetAt(0) -> SetPBString(mystr);
session -> InvokeClassFunction(cls, mid, ci);

```

Usage

On return, this method allocates enough spaces for the arguments, and then initializes arguments and return value. You must set appropriate values in the PBCallInfo structure. Note that the structure itself must have been allocated before the call.

See also

[InvokeObjectFunction](#)

7.6.59 InvokeObjectFunction

Description

Invokes a class member method.

Syntax

```
InvokeObjectFunction(pbobject obj, pbmethodID mid, PBCallInfo *ci)
```

Table 7.58:

Argument	Description
obj	The pbobject containing the method
mid	The pbMethodID returned by GetMethodID
ci	A pointer to a preallocated PBCallInfo structure

Return value

PBXRESULT. Returns PBX_OK for success, or one of the following for failure:

PBX_E_INVALID_ARGUMENT

PBX_E_INVOKE_METHOD_INACCESSABLE

PBX_E_INVOKE_WRONG_NUM_ARGS

PBX_E_INVOKE_REFARG_ERROR

PBX_E_INVOKE_METHOD_AMBIGUOUS

PBX_E_INVOKE_FAILURE

PBX_E_INVOKE_FAILURE

Examples

This code invokes the DataWindow Update function and returns its integer return value:

```

pbclass cls;
pbmethodID mid;
PBCallInfo* ci = new PBCallInfo;
pbint ret_val;

cls = session->GetClass(dwobj);
mid = session->GetMethodID (cls, "Update", PBRT_FUNCTION, "I");
session->InitCallInfo(cls, mid, ci);

session->InvokeObjectFunction(dwobj, mid, ci);

ret_val = ci.returnValue->GetInt();
session->FreeCallInfo(ci);
delete ci;
return ret_val;

```

See also[InvokeClassFunction](#)**7.6.60 IsArrayItemNull****Description**

Returns true if the array item contains a null value; otherwise it returns false.

Syntax

```
IsArrayItemNull( pbarray array, pblong dim[ ] )
```

Table 7.59:

Argument	Description
array	A valid pbarray structure that you want to check for a null-valued array item.
dim	A pblong array to hold the indexes of each dimension of the array. The size of the array must equal the dimensions of array.

Return value

pbboolean.

See also[GetArrayItemType](#)[Set<type>ArrayItem](#)[SetArrayItemToNull](#)**7.6.61 IsAutoInstantiate****Description**

Returns true if the specified class is an autoinstantiated class; otherwise it returns false.

Syntax

```
IsAutoInstantiate(pbclass)
```

Table 7.60:

Argument	Description
cls	A valid class handle or structure

Return value

pbboolean.

7.6.62 IsFieldArray**Description**

Returns true if the field of the specified object is an array; otherwise it returns false.

Syntax

```
IsFieldArray(pbclass cls, pbfield fid)
```

Table 7.61:

Argument	Description
cls	A valid class handle for the class whose field is to be accessed
fid	The field ID of the specified object

Return value

pbboolean.

Examples

This code tests whether the field identified by fid is an array, and if so, gets the array value:

```
fid = session->GetFieldID(cls, "arr_val");
if (session->IsFieldArray(cls, fid))
{
    arr_val=session->GetArrayField(myobj, fid, isNull);
    ...
}
```

See also

[GetFieldID](#)

[GetFieldType](#)

[Get<type>Field](#)

[GetNumOfFields](#)

[IsFieldNull](#)

[IsFieldObject](#)

[SetFieldToNull](#)

[Set<type>Field](#)

7.6.63 IsFieldNull**Description**

Returns true if the field of the specified object is a null value; otherwise it returns false.

Syntax

```
IsFieldNull(pbobject obj, pbfield fid)
```

Table 7.62:

Argument	Description
obj	A valid object handle for the object whose field is to be accessed
fid	The field ID of the specified object

Return value

pbboolean.

Examples

These statements test whether the field identified by fid is null:

```
fid = session -> GetFieldID(cls, "i_val");
if (session -> IsFieldNull(myobj, fid))
```

See also

[GetFieldID](#)

[GetFieldType](#)

[Get<type>Field](#)

[GetNumOfFields](#)

[IsFieldArray](#)

[IsFieldObject](#)

[SetFieldToNull](#)

[Set<type>Field](#)

7.6.64 IsFieldObject

Description

Returns true if the field of the specified object is an object; otherwise it returns false.

Syntax

```
IsFieldObject(pbclass cls, pbfield fid)
```

Table 7.63:

Argument	Description
cls	A valid class handle for the class whose field is to be accessed
fid	The field ID of the specified object

Return value

pbboolean.

Examples

These statements test whether the field identified by fid is an object:

```
fid = session -> GetFieldID(cls, "obj_val");
if (session -> IsFieldObject(myobj, fid))
```

See also

[GetFieldID](#)

[GetFieldType](#)

[Get<type>Field](#)

[GetNumOfFields](#)

[IsFieldArray](#)

[IsFieldNull](#)

[SetFieldToNull](#)

[Set<type>Field](#)

7.6.65 IsGlobalVarArray

Description

Returns true if the global variable contains an array; otherwise it returns false.

Syntax

```
IsGlobalVarArray(pbfield fid)
```

Table 7.64:

Argument	Description
fid	The field ID of the global variable

Return value

pbboolean.

Examples

These statements test whether the field identified by fid is a global variable array:

```
fid = session -> GetGlobalVarID("arr_gvar");
if (session -> IsGlobalVarArray(fid))
{
    arr_val=session -> GetArrayGlobalVar(fid, isNull);
    ...
}
```

See also

[GetGlobalVarID](#)

[GetGlobalVarType](#)

[Get<type>GlobalVar](#)

[IsGlobalVarNull](#)[IsGlobalVarObject](#)[SetGlobalVarToNull](#)[Set<type>GlobalVar](#)

7.6.66 IsGlobalVarNull

Description

Returns true if the global variable contains a null value; otherwise it returns false.

Syntax

```
IsGlobalVarNull( pbfield fid)
```

Table 7.65:

Argument	Description
fid	The field ID of the global variable

Return value

pbboolean.

Examples

These statements test whether the field identified by fid is a global variable array:

```
fid = session -> GetGlobalVarID("arr_gvar");
if (session -> IsGlobalVarArray(fid))
{
    arr_val=session -> GetArrayGlobalVar(fid, isNull);
    ...
}
```

See also

[GetGlobalVarID](#)[GetGlobalVarType](#)[Get<type>GlobalVar](#)[IsGlobalVarArray](#)[IsGlobalVarObject](#)[SetGlobalVarToNull](#)[Set<type>GlobalVar](#)

7.6.67 IsGlobalVarObject

Description

Returns true if the global variable contains an object; otherwise it returns false.

Syntax

```
IsGlobalVarObject( pbfield fid)
```

Table 7.66:

Argument	Description
fid	The field ID of the global variable

Return value

pbboolean.

Examples

These statements test whether the field identified by fid is a global variable object. If it is, its value is set to another global variable object:

```
fid = session -> GetGlobalVarID("obj2_gvar");
if (session -> IsGlobalVarObject(fid))
{
    obj_val = session -> GetObjectGlobalVar(fid,
        isNull);
    cls = session -> GetClass(obj_val);
    fid = session -> GetFieldID(cls, "text");
    s_val = session -> GetStringField(obj_val, fid,
        isNull);
    mystr = session -> GetString(s_val);
    // Set the value of obj2_gvar to obj1_gvar
    fid = session -> GetGlobalVarID("obj1_gvar");
    session -> SetObjectGlobalVar(fid, obj_val);
}
```

See also

[GetGlobalVarID](#)

[GetGlobalVarType](#)

[Get<type>GlobalVar](#)

[IsGlobalVarArray](#)

[IsGlobalVarNull](#)

[SetGlobalVarToNull](#)

[Set<type>GlobalVar](#)

7.6.68 IsNativeObject**Description**

Determines whether a pbject is an instance of a native class.

Syntax

```
IsNativeObject(pbject obj)
```

Table 7.67:

Argument	Description
obj	A valid object handle

Return value

pbboolean.

Examples

The `f_getrow` function uses `IsNativeObject` to test whether `extObj` is a native class. If so, it gets the native interface and invokes the `f_getrowcount` function in the other class:

```
long f_getrow(IPB_Session* session, pobject dwObj,
             pobject extObj)
{
    long lRet;
    IMy_pbni* pMy_pbni = NULL;
    IPBX_NonVisualObject* pp=NULL;

    if (session -> IsNativeObject(extObj) )
    {
        pp = (IPBX_NonVisualObject*) session ->
            GetNativeInterface(extObj);
        pMy_pbni = static_cast<IMy_pbni*>(pp);
        lRet = pMy_pbni-> f_GetRowCount(session, dwObj);
    }
    return lRet;
}
```

Usage

Use this method in conjunction with `GetNativeInterface` to obtain a direct reference to the `IPBX_UserObject` associated with another native class, so that the class and its methods can be accessed directly.

See also

[GetNativeInterface](#)

7.6.69 IsSharedVarArray

Description

Returns true if the shared variable contains an array; otherwise it returns false.

Syntax

```
IsSharedVarArray(pbgrou group, pbfield fid)
```

Table 7.68:

Argument	Description
group	The group whose shared variable is to be accessed
fid	The field ID of the shared variable

Return value

pbboolean.

See also

[Get<type>SharedVar](#)

[GetSharedVarID](#)

[GetSharedVarType](#)

[IsSharedVarNull](#)[IsSharedVarObject](#)[Set<type>SharedVar](#)[SetSharedVarToNull](#)

7.6.70 IsSharedVarNull

Description

Returns true if the shared variable contains a null value; otherwise it returns false.

Syntax

```
IsSharedVarNull(pbgroup group, pbfield fid)
```

Table 7.69:

Argument	Description
group	The group whose shared variable is to be accessed
fid	The field ID of the shared variable

Return value

pbboolean.

See also

[Get<type>SharedVar](#)[GetSharedVarID](#)[GetSharedVarType](#)[IsSharedVarArray](#)[IsSharedVarObject](#)[Set<type>SharedVar](#)[SetSharedVarToNull](#)

7.6.71 IsSharedVarObject

Description

Returns true if the shared variable contains an object; otherwise it returns false.

Syntax

```
IsSharedVarObject(pbgroup group, pbfield fid)
```

Table 7.70:

Argument	Description
group	The group whose shared variable is to be accessed

Argument	Description
fid	The field ID of the shared variable

Return value

pbboolean.

See also

[Get<type>SharedVar](#)

[GetSharedVarID](#)

[GetSharedVarType](#)

[IsSharedVarArray](#)

[IsSharedVarNull](#)

[Set<type>SharedVar](#)

[SetSharedVarToNull](#)

7.6.72 NewBlob**Description**

Creates a new blob and duplicates a buffer for the new blob data.

Syntax

```
NewBlob (const void* bin, pblong len)
```

Table 7.71:

Argument	Description
bin	A void pointer that points to the source buffer
len	The length in bytes of the data in the buffer

Return value

pbblob.

Examples

If the blob value in the PBCallInfo structure is null, this code creates a new blob value with four bytes in the pArguments array; otherwise, it sets the blob value in the pArguments array to the value in the PBCallInfo structure:

```
if (ci->pArgs->GetAt(i)->IsNull())
    pArguments[i].blob_val =
        Session->NewBlob("null", 4);
else    pArguments[i].blob_val =
        ci->pArgs->GetAt(i)->GetBlob();
```

Usage

The buffer containing the new blob data is freed when PopLocalFrame is called.

See also

[PopLocalFrame](#)[SetBlob](#)

7.6.73 NewBoundedObjectArray

Description

Creates a bounded PowerBuilder object or structure array.

Syntax

```
NewBoundedObjectArray(pbclass cls, pbuint dimension, PBArrInfo::ArrayBound*
bounds)
```

Table 7.72:

Argument	Description
cls	A valid class handle of the type of PowerBuilder object or structure array to be created
dimension	A number greater than one that indicates the dimension of the array to be created
bounds	An array containing the upper and lower boundaries of the array to be created

Return value

pbarray or null on failure.

Examples

```
int size;
pbarray pbin_a;
PBArrInfo* ai;
PBXRESULT ret;
pbclass cls;
pbgroup group;

size = sizeof(PBArrInfo) +
    sizeof(PBArrInfo::ArrayBound);
ai = (PBArrInfo*)malloc(size);
ai-> bounds[0].upperBound=2;
ai-> bounds[0].lowerBound=1;
ai-> bounds[1].upperBound=2;
ai-> bounds[1].lowerBound=1;
ai-> numDimensions=2;

// Create new array pbin_a
group = session-> FindGroup("w_main", pbgroup_window);
if (group==NULL)
    return;
cls = session->FindClass(group, "commandbutton");
if( cls==NULL)
    return;
pbin_a = session->NewBoundedObjectArray(cls,
    ai-> numDimensions, ai-> bounds);
```

See also

[Get<type>ArrayItem](#)[GetArrayInfo](#)[GetArrayItemType](#)[GetArrayLength](#)[IsArrayItemNull](#)[NewBoundedSimpleArray](#)[NewUnboundedObjectArray](#)[NewUnboundedSimpleArray](#)[ReleaseArrayInfo](#)[SetArrayItemToNull](#)[SetArrayItemValue](#)[Set<type>ArrayItem](#)

7.6.74 NewBoundedSimpleArray

Description

Creates a bounded simple data array.

Syntax

```
NewBoundedSimpleArray(pbuint type, pbuint dimension, PBArraryInfo::ArrayBound* bounds)
```

Table 7.73:

Argument	Description
type	An enumerated variable of type pbvalue_* indicating the type of simple unbounded array to be created
dimension	A number greater than one that indicates the dimension of the array to be created
bounds	An array containing the upper and lower boundaries of the array to be created

Return value

pbarray or null on failure.

See also

[Get<type>ArrayItem](#)[GetArrayInfo](#)[GetArrayItemType](#)[GetArrayLength](#)[IsArrayItemNull](#)

[NewBoundedObjectArray](#)[NewUnboundedObjectArray](#)[NewUnboundedSimpleArray](#)[ReleaseArrayInfo](#)[SetArrayItemToNull](#)[SetArrayItemValue](#)[Set<type>ArrayItem](#)

7.6.75 NewDate

Description

Creates a new pbddate data object.

Syntax

```
NewDate()
```

Return value

pbddate.

Examples

This example tests whether a date value exists, and, if it does not, it creates a new pbddate object and sets its value to the first day in January, 1900:

```
if (ci->pArgs->GetAt(0)->IsNull())
{
    pArguments[i].date_val = Session->NewDate();
    Session->SetDate(pArguments[i].date_val,
        1900,1,1); // Date: 1900-01-01
    isNull[i]=true;
}
else
{
    pArguments[i].date_val =
        ci->pArgs->GetAt(i)->GetDate();
    isNull[i]=false;
}
```

Usage

The initial value is 1900-1-1.

See also

[SetDate](#)[SplitDate](#)

7.6.76 NewDateTime

Description

Creates a new pbdatetime data object.

Syntax

```
NewDateTime()
```

Return value

pbdatetime.

Examples

This example tests whether a date/time value exists, and, if it does not, it creates a new pbdate object and sets its value to the beginning of January, 1900:

```
if (ci->pArgs->GetAt(i)->IsNull())
{
    pArguments[i].datetime_val=Session->NewDateTime();
    Session->SetDateTime(pArguments[i].datetime_val,
        1900, 1 , 1, 1, 1, 1); // Datetime:
                               // 1900-01-01 01:01:01
}
else
{
    pArguments[i].datetime_val =
        ci->pArgs->GetAt(i)->GetDateTime();
}
```

Usage

The initial value is 1900-1-1 0:0:0.0.

See also

[SetDateTime](#)

[SplitDateTime](#)

7.6.77 NewDecimal

Description

Allocates resources for a new decimal data object.

Syntax

```
NewDecimal( )
```

Return value

pbdec or null on failure.

Examples

```
if (ci->pArgs->GetAt(i)->IsNull())
{
    pArguments[i].dec_val=Session->NewDecimal();
    Session->SetDecimal(pArguments[i].dec_val, "1.0");
}
else
    pArguments[i].dec_val =
        ci->pArgs->GetAt(i)->GetDecimal();
```

See also

[GetDecimalString](#)

[ReleaseDecimalString](#)

[SetDecimal](#)

7.6.78 NewObject

Description

Creates a new object of the specified type.

Syntax

```
NewObject(pbclass cls)
```

Table 7.74:

Argument	Description
cls	The type of object or structure instance to be created

Return value

pbobject of the given class or structure.

Examples

```
pbclass cls;
pbobject ex;
pbgroup group;

group = session-> FindGroup ("user_exception", pbgroup_userobject);
if (group==NULL)
    return;
cls = session->FindClass(group, "user_exception");
if (group==NULL)
    return;
ex = session->NewObject(cls);
```

Usage

The returned object's life cycle is restricted to the current frame unless AddGlobalRef is called on the object.

See also

[FindClass](#)

[FindGroup](#)

7.6.79 NewProxyObject

Description

Creates a proxy for a remote object. The proxy is used to extend the network protocol in PowerBuilder.

Syntax

```
NewProxyObject(pbclass cls)
```

Table 7.75:

Argument	Description
cls	The type of object or structure instance to be created

Return value

pbproxyobject.

Examples

This example creates a new proxy object, creates a marshaler, and associates the marshaler with the proxy object:

```
pbproxyObject proxy = session->NewProxyObject(cls);
if (proxy == NULL)
{
    ci->returnValue->SetLong(kFailToCreateProxy);
    return PBX_OK;
}

// Create MyMarshaler
MyMarshaler* marshaler = new MyMarshaler (env, proxy, obj);

// Associate MyMarshaler with the proxy
session->SetMarshaler(proxy, marshaler);

ci->pArgs->GetAt(0)->SetObject(proxy);

ci->returnValue->SetLong(kSuccessful);

return PBX_OK;
```

See also

[GetMarshaler](#)

[SetMarshaler](#)

7.6.80 NewString

Description

Creates a new string.

Syntax

```
NewString(LPCTSTR)
```

Return value

pbstring.

Examples

```
pbclass cls;

cls = session->GetSystemFunctionsClass();
if( cls == NULL )
{
    ret_val = session->NewString("null");
    return ret_val;
}
```

Usage

The returned string is destroyed when PopLocalFrame is called.

See also

[SetString](#)**7.6.81 NewTime****Description**

Creates a new pbtime data object.

Syntax

```
NewTime()
```

Return value

pbtime.

Examples

These statements split a time into hours, minutes, and seconds, and then use the resulting values to set the value of a new time object:

```
Session->SplitTime(ci.returnValue->GetTime(), &hh,
    &mm, &ss);
ret_val = Session-> NewTime();
Session-> SetTime(ret_val, hh, mm, ss);
```

Usage

The initial value is 0:0:0.0.

See also

[SetTime](#)

[SplitTime](#)

7.6.82 NewUnboundedObjectArray**Description**

Creates an unbounded PowerBuilder object or structure data array.

Syntax

```
NewUnboundedObjectArray(pbclass cls)
```

Table 7.76:

Argument	Description
cls	A valid class handle of the type of PowerBuilder object or structure array to be created

Return value

pbarray or null on failure.

Usage

An unbounded array can have only one dimension, so no dimension information is needed.

See also

[Get<type>ArrayItem](#)[GetArrayInfo](#)[GetArrayItemType](#)[GetArrayLength](#)[IsArrayItemNull](#)[NewBoundedObjectArray](#)[NewBoundedSimpleArray](#)[NewUnboundedSimpleArray](#)[ReleaseArrayInfo](#)[SetArrayItemToNull](#)[SetArrayItemValue](#)[Set<type>ArrayItem](#)

7.6.83 NewUnboundedSimpleArray

Description

Creates an unbounded simple data array.

Syntax

```
NewUnboundedSimpleArray(pbuint type)
```

Table 7.77:

Argument	Description
type	An enumerated variable of type pbvalue_* indicating the type of simple unbounded array to be created

Return value

pbarray or null on failure.

Examples

This example creates an unbounded simple data array of the type returned by the `getDataType` method, which returns a string of the form `dt_type`. Most of the case statements have been removed for the sake of brevity:

```
if (d_returnType.isArray())
{
    returnValue.l = env->CallObjectMethodA(obj,
        mid, values.get());
    pbarray v;

    switch(d_returnType.getDataType())
    {
    case dt_boolean:
        v = session->NewUnboundedSimpleArray
            (pbvalue_boolean);
    }
}
```

```
        break;

        case dt_short:
            v = session->NewUnboundedSimpleArray
                (pbvalue_int);
            break;
// CASE statements omitted
...
        default:
            v = session->NewUnboundedSimpleArray
                (pbvalue_any);
            break;
    }

    ci->returnValue->SetArray(v);
```

Usage

An unbounded array can have only one dimension, so no dimension information is needed.

See also

[Get<type>ArrayItem](#)

[GetArrayInfo](#)

[GetArrayItemType](#)

[GetArrayLength](#)

[IsArrayItemNull](#)

[NewBoundedObjectArray](#)

[NewBoundedSimpleArray](#)

[NewUnboundedObjectArray](#)

[ReleaseArrayInfo](#)

[SetArrayItemToNull](#)

[SetArrayItemValue](#)

[Set<type>ArrayItem](#)

7.6.84 PopLocalFrame

Description

Pops the current local reference frame from the current native method stack frame, removing all local references to the objects added in that local frame. All the pobject, pbstring, and pbdecimal variables created by calling [NewDecimal](#), [NewObject](#), or [NewString](#) in the current frame are destroyed automatically.

Syntax

```
PopLocalFrame()
```

Return value

None.

See also

[AddLocalRef](#)[PushLocalFrame](#)[RemoveLocalRef](#)

7.6.85 ProcessPBMessage

Description

Checks the PowerBuilder message queue and, if there is a message in the queue, attempts to process it.

Syntax

```
ProcessPBMessage()
```

Return value

pbboolean.

Returns true if a PowerBuilder message was processed, and false otherwise.

Examples

This message loop in a WinMain function processes a PowerBuilder message if a message has been received and an IPB session is running:

```
try {
    while (GetMessage(&msg, NULL, 0, 0))
    {
        TranslateMessage(&msg);
        DispatchMessage(&msg);

        // Call to ProcessPBMessage
        if (session)
            session->ProcessPBMessage();
    }
}
```

This overloaded WindowProc function in an MFC application processes a PowerBuilder message:

```
LRESULT CCallPBVCtrl::WindowProc(UINT message,
    WPARAM wParam, LPARAM lParam)
{
    d_session->ProcessPBMessage();
    return CDialog::WindowProc(message, wParam, lParam);
}
```

Usage

Each time this function is called, it attempts to retrieve a message from the PowerBuilder message queue and process it. It is similar to the PowerBuilder Yield function; however, ProcessPBMessage processes only one message at a time, and it processes only PowerBuilder messages. The Yield function also processes Windows messages.

Use this function when PowerBuilder windows or visual controls are called from C++ applications or from extensions to ensure that events posted to the PowerBuilder message queue are processed.

If the function is not inserted in the C++ application in a way that results in it being called repeatedly, posted events are not processed in the PowerBuilder application.

For most applications, `ProcessPBMessage` can be inserted in a message loop in the `WinMain` function. If you use Microsoft Foundation Classes (MFC), you cannot modify the built-in message loop. To ensure that the `ProcessPBMessage` function is called repeatedly, you can overload the `CWnd::WindowProc` function and insert `ProcessPBMessage` into the overloaded function.

7.6.86 PushLocalFrame

Description

Pushes a local reference frame onto the current native method stack frame. A local frame is analogous to a scope in C++.

Syntax

```
PushLocalFrame()
```

Return value

None.

See also

[PopLocalFrame](#)

[RemoveLocalRef](#)

7.6.87 Release

Description

Releases the current `IPB_Session`. The `IPB_Session` object becomes invalid after the call.

Syntax

```
Release()
```

Return value

None.

Examples

This example shows a call to `Release`. The example checks whether there is a valid session object before attempting to release it:

```
if (pIPB_ObjectFactory)
{
    pIPB_ObjectFactory->Release();
    pIPB_ObjectFactory = NULL;
}
```

7.6.88 ReleaseArrayInfo

Description

Releases memory returned by `GetArrayInfo`.

Syntax

```
ReleaseArrayInfo(PBArrayInfo* pbarrayinfo)
```

Table 7.78:

Argument	Description
pbarrayinfo	A valid PBArryInfo handle

Return value

PBXRESULT. PBX_OK for success.

Examples

This example shows how ReleaseArrayInfo should be called when memory allocated by GetArrayInfo is no longer needed:

```
PBArrayInfo* ai;
...
session->ReleaseArrayInfo(ai);
```

Usage

If the array is an unbounded array, the bounds information in PBArryInfo is undetermined.

See also

[Get<type>ArrayItem](#)

[GetArrayInfo](#)

[GetArrayItemType](#)

[GetArrayLength](#)

[IsArrayItemNull](#)

[NewBoundedObjectArray](#)

[NewBoundedSimpleArray](#)

[NewUnboundedObjectArray](#)

[NewUnboundedSimpleArray](#)

[SetArrayItemToNull](#)

[SetArrayItemValue](#)

[Set<type>ArrayItem](#)

7.6.89 ReleaseDateString**Description**

Frees the memory acquired using [GetDateString](#).

Syntax

```
ReleaseDateString(LPCTSTR string)
```

Table 7.79:

Argument	Description
string	The string to be released from memory

Return value

None.

See also

[GetString](#)

7.6.90 ReleaseDateTimeString

Description

Frees the memory acquired using [GetDateTimeString](#).

Syntax

```
ReleaseDateTimeString(LPCTSTR string)
```

Table 7.80:

Argument	Description
string	The string to be released from memory

Return value

None.

See also

[GetDateTimeString](#)

7.6.91 ReleaseDecimalString

Description

Frees the memory acquired using [GetDecimalString](#).

Syntax

```
ReleaseDecimalString(LPCTSTR string)
```

Table 7.81:

Argument	Description
string	The string to be released from memory

Return value

None.

See also

[GetDecimalString](#)

7.6.92 ReleaseResultSetAccessor

Description

Releases the pointer obtained using [GetResultSetAccessor](#).

Syntax

```
ReleaseResultSetAccessor (IPB_ResultSetAccessor* rs)
```

Table 7.82:

Argument	Description
rs	A pointer to the IPB_ResultSetAccessor object to be released

Return value

None.

Examples

This statement releases the IPB_ResultSetAccessor object rsa:

```
Session->ReleaseResultSetAccessor(rsa);
```

Usage

When you call ReleaseResultSetAccessor, the Release function of the IPB_ResultSetAccessor interface is called on the rs argument to release the interface pointer.

See also

[CreateResultSet](#)

[GetResultSetAccessor](#)

7.6.93 ReleaseString**Description**

Frees the memory acquired using GetString, GetClassName, GetFieldName, or GetEnumItemName.

Syntax

```
ReleaseString(LPCTSTR string)
```

Table 7.83:

Argument	Description
string	The string to be released from memory

Return value

None.

Examples

The following example gets a pointer to each of two strings passed in as arguments, concatenates them in a new string, then releases the memory used by the original strings:

```
pbstring pspccls:: f_add_string(IPB_Session* session, pbstring arg1, pbstring arg2)
{
    LPCTSTR pStr1,pStr2;
    TCHAR tmp[100];
    pbstring ret;

    pStr1=session-> GetString(arg1);
    pStr2=session-> GetString(arg2);
    _tcscpy(tmp,pStr1);
```



```

_tcscat(tmp,pStr2);
ret = session -> NewString(tmp);
session-> ReleaseString(pStr1);
session-> ReleaseString(pStr2);

return ret ;
}

```

Usage

Do not use this function to release a string obtained using `GetString`, `GetTimeString`, `GetDateTimeString`, or `GetDecimalString`. Each of these Get methods has a corresponding Release method.

See also

[GetClassName](#)

[GetEnumItemName](#)

[GetFieldName](#)

[GetString](#)

7.6.94 ReleaseTimeString

Description

Frees the memory acquired using [GetString](#).

Syntax

```
ReleaseTimeString(LPCTSTR string)
```

Table 7.84:

Argument	Description
string	The string to be released from memory

Return value

None.

See also

[GetTimeString](#)

7.6.95 ReleaseValue

Description

Frees the IPB_Value acquired using `AcquireValue` or `AcquireArrayItemValue`.

Syntax

```
ReleaseValue(IPB_Value* value)
```

Table 7.85:

Argument	Description
value	The string to be released from memory

Return value

None.

Examples

The `AcquireValue` method is used to obtain a message argument value. Later, when the value is no longer needed, it is released using `ReleaseValue` to avoid memory leaks:

```
// Acquire a value
MessageArg = session->AcquireValue
    ( ci->pArgs->GetAt(0) );
pbstring pbMessage = MessageArg->GetString() ;
Message = (LPSTR)session->GetString(pbMessage) ;
...
// Cleanup phase
if (MessageArg)
{
    Session->ReleaseValue ( MessageArg ) ;
}
```

Usage

When you no longer need the data acquired using the `AcquireValue` or `AcquireArrayItemValue` method, you must call the `ReleaseValue` method to free the data. Failing to do so causes a memory leak.

Warning

Do not use `ReleaseValue` to release a value that was not acquired using `AcquireValue` or `AcquireArrayItemValue`. If you do, the PowerBuilder VM might crash.

See also

[AcquireArrayItemValue](#)

[AcquireValue](#)

7.6.96 RemoveGlobalRef

Description

Removes a global reference to the specified PowerBuilder object.

Syntax

```
RemoveGlobalRef (pbobject obj)
```

Table 7.86:

Argument	Description
obj	A valid PowerBuilder object handle

Return value

None.

Examples

```
void MyPBNIClass::reference()
```

```

{
    d_session->AddGlobalRef(d_pobject);
}

void MyPBNIClass::unreference()
{
    if(d_pobject != NULL)
        d_session -> RemoveGlobalRef(d_pobject);
}

```

See also[AddGlobalRef](#)**7.6.97 RemoveLocalRef****Description**

Removes a local reference to the specified PowerBuilder object.

Syntax

```
RemoveLocalRef (pobject obj)
```

Table 7.87:

Argument	Description
obj	A valid PowerBuilder object handle

Return value

None.

See also[AddLocalRef](#)[PopLocalFrame](#)[PushLocalFrame](#)**7.6.98 RemoveProp****Description**

Removes the specified variable from the list of properties of the current IPB session. You must free the memory to which the property points.

Syntax

```
RemoveProp(LPCTSTR name)
```

Table 7.88:

Argument	Description
name	The name of the variable to be removed

Return value

None.

Examples

These statements remove `prop_name` from the list of variables associated with the session and delete the pointer created to point to the variables value:

```
session -> RemoveProp(prop_name);
delete SetValue;
```

Usage

SetProp enables you to use a variable value throughout an IPB session. Use RemoveProp to remove the variable from the list of variables associated with the session when it is no longer needed. You must also free the memory associated with the variable.

See also

[GetProp](#)

[SetProp](#)

7.6.99 RestartRequested

Description

Determines whether the PowerBuilder system function Restart has been called.

Syntax

```
HasPBVisualObject()
```

Return value

pbboolean.

Returns true when the PowerBuilder system function Restart is called. When RestartRequested returns true, you should destroy the existing IPB_Session object and create a new one to restart the application.

Examples

In the following example, StartApplication, RecreateSession, and CleanApplication are functions of the PB_MyConsoleAppRunner class. StartApplication is similar to the IP_VM RunApplication function, but it uses an existing session. RecreateSession releases the current session and creates a new one. CleanApplication triggers the application's Close event and releases resources. In the example, RestartRequested is called in a DO loop to test whether the PowerBuilder Restart function has been called. If it has, the RecreateSession function is called:

```
PBXRESULT PB_MyConsoleAppRunner::RunApplication()
{
    PBXRESULT res;
    pbboolean restart = FALSE;

    do
    {
        res = StartApplication();
        if (res != PBX_OK)
            break;

        restart = GetSession()->RestartRequested();
        if (restart)
```

```

        RecreateSession();
    } while (restart);
    return CleanApplication();
}

```

Usage

RestartRequested and HasVisualPObject are used in the implementation of the IPB_VM RunApplication function. You no longer need to use an external message loop to check for Windows messages when you call the RunApplication function as you did in versions of PBNI prior to PowerBuilder 10.5.

See also

[HasPBVisualObject](#)

[RunApplication](#)

7.6.100 Set<type>ArrayItem

Description

Assigns a value to an array item of a specific type.

Syntax

```

SetBlobArrayItem ( pbarray array, pblong dim[ ], pblob value )
SetBoolArrayItem ( pbarray array, pblong dim[ ], pbboolean value )
SetByteArrayItem ( pbarray array, pblong dim[ ], pbbyte value )
SetCharArrayItem ( pbarray array, pblong dim[ ], pbchar value )
SetDateArrayItem ( pbarray array, pblong dim[ ], pbdate value )
SetDateTimeArrayItem ( pbarray array, pblong dim[ ], pbdatetime value )
SetDecArrayItem ( pbarray array, pblong dim[ ], pbdec value )
SetDoubleArrayItem ( pbarray array, pblong dim[ ], pbdouble value )
SetIntArrayItem ( pbarray array, pblong dim[ ], pbint value )
SetLongArrayItem ( pbarray array, pblong dim[ ], pblong value )
SetLongLongArrayItem ( pbarray array, pblong dim[ ], pblong value )
SetObjectArrayItem ( pbarray array, pblong dim[ ], pobject obj )
SetPBStringArrayItem ( pbarray array, pblong dim[ ], pbstring value )
SetRealArrayItem ( pbarray array, pblong dim[ ], pbrreal value )
SetStringArrayItem ( pbarray array, pblong dim[ ], LPCTSTR value )
SetTimeArrayItem ( pbarray array, pblong dim[ ], pbtime value )
SetUIntArrayItem ( pbarray array, pblong dim[ ], pbuint value )
SetUlongArrayItem ( pbarray array, pblong dim[ ], pbulong value )

```

Table 7.89:

Argument	Description
array	A valid pbarray handle.
dim	A pblong array to hold indexes of each dimension. The number of dimensions must equal the number of dimensions of the array.
value	The new value of the array item.

Return value

PBXRESULT. PBX_OK for success.

If the index exceeds the bounds of a bounded array, it returns `PBX_E_ARRAY_INDEX_OUTOF_BOUNDS`.

If the data passed in does not match the datatype of the array, it returns `PBX_E_MISMATCHED_DATA_TYPE`.

Examples

This example creates a new unbounded simple array. In the FOR loop, application-specific code (not shown here) gets array values, which are then added to the array using `SetPBStringArrayItem`:

```
pblong          dim[1];
char *          cstr;
pbuint         numDimensions = 1;
PBArrayInfo::ArrayBound bound;

bound.lowerBound = 1;
bound.upperBound = size;
d_pbararray = d_session->NewBoundedSimpleArray
    (pbvalue_string, numDimensions, &bound);

for (int i = 1; i <= size; i++ )
{
    dim[0] = i;
    // add application-specific code here to
    // get array value
    pbstring pValue = d_session->NewString(cstr);
    d_session->SetPBStringArrayItem(d_pbararray, dim, pValue);

    delete [] cstr;
}
pbv.SetArray(d_pbararray);
```

Usage

This method assigns the `IPB_Value` pointed to by the value argument to the array item in the same way that the `IPB_Value` [Set<type>](#) method sets a value.

See also

[Get<type>ArrayItem](#)

[GetArrayInfo](#)

[GetArrayItemType](#)

[GetArrayLength](#)

[IsArrayItemNull](#)

[NewBoundedObjectArray](#)

[NewBoundedSimpleArray](#)

[NewUnboundedObjectArray](#)

[NewUnboundedSimpleArray](#)

[ReleaseArrayInfo](#)

[SetArrayItemToNull](#)

[SetArrayItemValue](#)

7.6.101 Set<type>Field

Description

A set of methods that set a new value in an instance field of an object.

Syntax

```
SetArrayField ( pobject obj, pbfieldID fid, parray value )
SetBlobField ( pobject obj, pbfieldID fid, pblob value )
SetBoolField ( pobject obj, pbfieldID fid, pboolean value )
SetByteField ( pobject obj, pbfieldID fid, pbyte value )
SetCharField ( pobject obj, pbfieldID fid, pchar value )
SetDateField ( pobject obj, pbfieldID fid, pdate value )
SetDateTimeField ( pobject obj, pbfieldID fid, pdatetime value )
SetDecField ( pobject obj, pbfieldID fid, pdec value )
SetDoubleField ( pobject obj, pbfieldID fid, pdouble value )
SetIntField ( pobject obj, pbfieldID fid, pint value )
SetLongField ( pobject obj, pbfieldID fid, plong value )
SetLongLongField ( pobject obj, pbfieldID fid, plonglong value )
SetObjectField ( pobject obj, pbfieldID fid, pobject value )
SetPBStringField ( pobject obj, pbfieldID fid, pstring value )
SetRealField ( pobject obj, pbfieldID fid, preal value )
SetStringField ( pobject obj, pbfieldID fid, LPCTSTR value )
SetTimeField ( pobject obj, pbfieldID fid, ptime value )
SetUIntField ( pobject obj, pbfieldID fid, puint value )
SetUlongField ( pobject obj, pbfieldID fid, pulong value )
```

Table 7.90:

Argument	Description
obj	The handle of the object whose field is to be accessed
fid	The field ID of the specified object
value	The value to be set

Return value

PBX_RESULT.

Examples

These statements set a new string value in a string field:

```
pbstring str = session->NewString(d_message.c_str());
if (str != NULL)
    session->SetPBStringField(d_pobj, d_fidMsg, str);
```

Usage

When you change any visual property of a PowerBuilder object by calling Set<type>field functions, the property is changed but the property is not refreshed in the graphical user interface. UpdateField refreshes the visual properties of PowerBuilder objects. You must call UpdateField explicitly when changing any visual property with the Set<type>field functions.

See also

[GetFieldID](#)

[GetFieldType](#)

[Get<type>Field](#)

[GetNumOfFields](#)[IsFieldArray](#)[IsFieldNull](#)[IsFieldObject](#)[SetFieldToNull](#)[UpdateField](#)

7.6.102 Set<type>GlobalVar

Description

A set of methods that set the value of a global variable of a specific datatype.

Syntax

```

SetArrayGlobalVar ( pbfieldID fid, parray value )
SetBlobGlobalVar ( pbfieldID fid, pblob value )
SetBoolGlobalVar ( pbfieldID fid, pboolean value )
SetByteGlobalVar ( pbfieldID fid, pbyte value )
SetCharGlobalVar ( pbfieldID fid, pchar value )
SetDateGlobalVar ( pbfieldID fid, pdate value )
SetDateTimeGlobalVar ( pbfieldID fid, pdatetime value )
SetDecGlobalVar ( pbfieldID fid, pdec value )
SetDoubleGlobalVar ( pbfieldID fid, pdouble value )
SetIntGlobalVar ( pbfieldID fid, pint value )
SetLongGlobalVar( pbfieldID fid, plong value )
SetLongLongGlobalVar( pbfieldID fid, plonglong value )
SetObjectGlobalVar ( pbfieldID fid, pobject value )
SetPBStringGlobalVar ( pbfieldID fid, pstring value )
SetRealGlobalVar ( pbfieldID fid, preal value )
SetStringGlobalVar ( pbfieldID fid, LPCTSTR value )
SetTimeGlobalVar ( pbfieldID fid, ptime value )
SetUIntGlobalVar ( pbfieldID fid, puint value )
SetULongGlobalVar ( pbfieldID fid, pulong value )

```

Table 7.91:

Argument	Description
fid	The field ID of the global variable
value	The value to be set

Return value

PBX_RESULT.

Examples

This shows how to add 1 to the value of a global variable:

```

fid = session -> GetGlobalVarID("l_gvar");
l_val = session -> GetLongGlobalVar(fid, isNull);
session -> SetLongGlobalVar(fid, l_val + 1);

```

See also

[GetGlobalVarID](#)[GetGlobalVarType](#)

[Get<type>GlobalVar](#)[IsGlobalVarObject](#)[SetGlobalVarToNull](#)

7.6.103 Set<type>SharedVar

Description

A set of methods that set the value of a shared variable of a specific datatype.

Syntax

```

SetArraySharedVar ( pbgroup group, pbfieldID fid, pbarray value )
SetBlobSharedVar ( pbgroup group, pbfieldID fid, pbblob value )
SetBoolSharedVar ( pbgroup group, pbfieldID fid, pbboolean value )
SetByteSharedVar ( pbgroup group, pbfieldID fid, pbbyte value )
SetCharSharedVar ( pbgroup group, pbfieldID fid, pbchar value )
SetDateSharedVar ( pbgroup group, pbfieldID fid, pbdate value )
SetDateTimeSharedVar ( pbgroup group, pbfieldID fid, pbdatetime value )
SetDecSharedVar ( pbgroup group, pbfieldID fid, pbdec value )
SetDoubleSharedVar ( pbgroup group, pbfieldID fid, pbdouble value )
SetIntSharedVar ( pbgroup group, pbfieldID fid, pbint value )
SetLongSharedVar( pbgroup group, pbfieldID fid, pblong value )
SetLongLongSharedVar( pbgroup group, pbfieldID fid, pblonglong value )
SetObjectSharedVar ( pbgroup group, pbfieldID fid, pbobject value )
SetPBStringSharedVar ( pbgroup group, pbfieldID fid, pbstring value )
SetRealSharedVar ( pbgroup group, pbfieldID fid, pbreal value )
SetStringSharedVar ( pbgroup group, pbfieldID fid, LPCTSTR value )
SetTimeSharedVar ( pbgroup group, pbfieldID fid, pbtime value )
SetUintSharedVar ( pbgroup group, pbfieldID fid, pbuint value )
SetUlongSharedVar ( pbgroup group, pbfieldID fid, pbulong value )

```

Table 7.92:

Argument	Description
group	The group whose shared variable is to be accessed
fid	The field ID of the shared variable
value	The value to be set

Return value

PBX_RESULT.

See also

[Get<type>SharedVar](#)[GetSharedVarID](#)[GetSharedVarType](#)[IsSharedVarArray](#)[IsSharedVarNull](#)[IsSharedVarObject](#)[SetSharedVarToNull](#)

7.6.104 SetArrayItemToNull

Description

Sets the value of an array item to a null value.

Syntax

```
SetArrayItemToNull( parray array, pblong dim[ ] )
```

Table 7.93:

Argument	Description
array	A valid parray structure in which you want to set an array item to null.
dim	A pblong array to hold the indexes of each dimension of the array. The size of the array must equal the dimensions of array.

Return value

pbboolean.

See also

[IsArrayItemNull](#)

7.6.105 SetArrayItemValue

Description

Sets the value of an array item to the value of an IPB_Value.

Syntax

```
SetArrayItemValue( parray array, pblong dim[ ], IPB_Value* src )
```

Table 7.94:

Argument	Description
array	A valid parray structure in which you want to set an array item to null.
dim	A pblong array to hold the indexes of each dimension of the array. The size of the array must equal the dimensions of array.
src	The value to which the array item is to be changed.

Return value

None.

Examples

This code sets the value of each item in an array:

```
for( i=1; i <= bound; i++)
{
    dim[0]= i;
```

```

    ipv = Session -> AcquireArrayItemValue(refArg, dim);
    Session -> SetArrayItemValue(*i_array, dim, ipv);
    Session -> ReleaseValue(ipv);
}

```

Usage

The SetArrayItemValue method does not verify that the datatype of the replacement value matches the datatype of the original value.

See also

[AcquireArrayItemValue](#)

[ReleaseValue](#)

[SetArrayItemToNull](#)

[SetValue](#)

7.6.106 SetBlob

Description

Destroys the existing data in a blob and copies data into it from a buffer.

Syntax

```
SetBlob (pblob blb, const void* bin, pblong len)
```

Table 7.95:

Argument	Description
blb	A valid pblob object whose value is to be reset
bin	A pointer to the source buffer
len	The length in bytes of the data in the buffer

Return value

PBXRESULT. Returns PBX_OK for success or PBX_E_INVALID_ARGUMENT if the new blob value is invalid; otherwise, returns PBX_E_OUTOF_MEMORY.

Usage

A deep copy is performed. The existing value is destroyed first, and then the contents of the bin argument are copied into a new value.

See also

[NewBlob](#)

7.6.107 SetDate

Description

Resets the value of the specified pbddate object.

Syntax

```
SetDate (pbddate date, pbint year, pbint month, pbint day)
```

Table 7.96:

Argument	Description
date	The pbdate object to be reset
year	A year in the range 1000 to 3000
month	A month in the range 1 to 12
day	A day in the range 1 to 31

Return value

PBX_RESULT. PBX_OK for success or PBX_E_INVALID_ARGUMENT if the new date is invalid.

Examples

This example sets the date to March 12, 1938:

```
session->SetDate(date_val, 1938, 3, 12);
```

Usage

If the parameters are invalid, the date is reset to 1900-1-1.

See also

[NewDate](#)

[SplitDate](#)

7.6.108 SetDateTime**Description**

Resets the value of the specified pbdatetime object.

Syntax

```
SetDate (pbdatetime dt, pbint year, pbint month, pbint day, pbint hour, pbint minute, pbdouble second)
```

Table 7.97:

Argument	Description
dt	The pbdatetime object to be reset
year	A year in the range 1000 to 3000
month	A month in the range 1 to 12
day	A day in the range 1 to 31
hour	An hour in the range 0 to 23
minute	A minute in the range 0 to 59
second	A second in the range 0 to 59.999999

Return value

PBX_RESULT. PBX_OK for success or PBX_E_INVALID_ARGUMENT if the new datetime is invalid.

Examples

This example sets the datetime value to August 19, 1982 at 10:30:45.10:

```
session->SetDate(date_val, 1982, 8, 19, 10, 30, 45.1);
```

Usage

If the parameters are invalid, the datetime value is reset to 1900-1-1 0:0:0.0.

See also

[NewDateTime](#)

[SplitDateTime](#)

7.6.109 SetDecimal

Description

Sets the value of a decimal variable to decimal data in a string.

Syntax

```
SetDecimal(pbdec dec, LPCTSTR dec_str)
```

Table 7.98:

Argument	Description
dec	The decimal data object to be set
dec_str	The string containing the data to be converted to a decimal

Return value

PBXRESULT. PBX_OK for success.

Examples

This example uses the IPB_Session SetDecimal method to set the value of a variable of type pbdec, then uses the IPB_Value SetDecimal method to set the return value in the PBCallInfo structure:

```
pbdec pbdecRet = NULL;
LPCTSTR lpDecValueToReturn = NULL;
...
pbdecRet = session -> NewDecimal();
session -> SetDecimal( pbdecRet,
    (LPCTSTR)lpDecValueToReturn);
ci -> returnValue -> SetDecimal(pbdecRet);
```

Usage

If the string contains invalid data, the decimal value is set to 0.0.

See also

[GetDecimalString](#)

[NewDecimal](#)

[ReleaseDecimalString](#)**7.6.110 SetFieldToNull****Description**

Sets the value of the specified field to null.

Syntax

```
SetFieldToNull(pbobject obj, pbfield fid)
```

Table 7.99:

Argument	Description
obj	A valid object handle
fid	The field ID of the specified object

Return value

None.

See also

[GetFieldID](#)

[GetFieldType](#)

[Get<type>Field](#)

[GetNumOfFields](#)

[IsFieldArray](#)

[IsFieldNull](#)

[IsFieldObject](#)

[Set<type>Field](#)

7.6.111 SetGlobalVarToNull**Description**

Sets the value of the specified global variable to null.

Syntax

```
SetGlobalVarToNull(pbobject obj, pbfield fid)
```

Table 7.100:

Argument	Description
fid	The field ID of the global variable

Return value

None.

See also

[GetGlobalVarID](#)

[GetGlobalVarType](#)[Get<type>GlobalVar](#)[IsGlobalVarArray](#)[IsGlobalVarNull](#)[IsGlobalVarObject](#)[Set<type>GlobalVar](#)

7.6.112 SetMarshaler

Description

Sets a marshaler that will be used to invoke remote methods and convert PowerBuilder data formats to the user's communication protocol.

Syntax

```
SetMarshaler(pbproxyObject obj, IPBX_Marshaler* marshaler)
```

Table 7.101:

Argument	Description
obj	An object of type pbproxyObject to be used as a proxy for a remote object that was created using NewProxyObject
marshaler	A class inherited from IPBX_Marshaler

Return value

None.

Examples

This example creates a JavaMarshaler class and associates it with a proxy object:

```
// Create JavaMarshaler
JavaMarshaler* marshaler = new JavaMarshaler (env, proxy, jobj);

// Associate the JavaMarshaler with the PB proxy
session->SetMarshaler(proxy, marshaler);

ci->pArgs->GetAt(0)->SetObject(proxy);

ci->returnValue->SetLong(kSuccessful);
return PBX_OK;
```

Usage

The SetMarshaler function associates an object of type IPBX_Marshaler with a PBProxy object. It is possible to associate multiple marshaler objects with a single proxy object. It is also possible to associate one marshaler object with multiple proxy objects. Neither of these is good coding practice and should be avoided.

Before calling SetMarshaler, you can call the IPB_Session GetMarshaler function to obtain an existing marshaler object associated with a given proxy object, and then destroy the existing marshaler object before associating a new marshaler with the proxy.

When a proxy object is destroyed, it calls the associated marshaler object's Destroy method. If multiple proxy objects are associated with a single marshaler object, you need to implement some form of reference counting. Otherwise, the marshaler object is destroyed when the first associated proxy object is destroyed, and subsequent calls to the marshaler object's Destroy method, when other associated proxy objects are destroyed, will throw exceptions.

To avoid these issues, there should be a one-to-one relationship between marshaler and proxy objects.

See also

[GetMarshaler](#)

[GetMethodID](#)

7.6.113 SetProp

Description

Adds a new variable to the list of properties of the current session or changes the value of an existing variable.

Syntax

```
SetProp(LPCTSTR name, void* data)
```

Table 7.102:

Argument	Description
name	The name of the property to be set
data	A pointer to the data buffer where the variable's value resides

Return value

None.

Examples

In this example, the native class has two functions. This is their description passed in the PBX_GetDescription function:

```
"subroutine f_setprop(int a)\n"
"function int f_getprop()\n"
```

The functions are associated with these enumerated values:

```
enum MethodIDs
{
    mid_SetProp = 0,
    mid_GetProp = 1
};
```

When the f_setprop function is called from PowerBuilder, the following code sets the value of the pointer SetVal to the integer value passed in by f_setprop, then registers that value in the session with the property name prop_name:

```
int* SetVal = new int;
```



```
if (mid == mid_SetProp)
{
    *SetValue = ci -> pArgs -> GetAt(0) -> GetInt();
    session -> SetProp(prop_name, SetVal);
}
```

When the `f_getprop` function is called, the following code uses `GetProp` to set the `GetValue` pointer to point to the value associated with `prop_name`, and then sets the return value to `*GetValue`:

```
if (mid == mid_GetProp)
{
    int* GetVal;
    GetValue = (int *)session -> GetProp(prop_name);
    ci -> returnValue -> SetInt(*GetVal);
}
```

Usage

`SetProp` enables you to use a variable value throughout an IPB session without using a global variable, which is susceptible to namespace conflicts with other sessions. `SetProp` is one of a set of three functions:

- Use `SetProp` to register a new variable with the session or to change the value of an existing variable.
- Use `GetProp` to access the variable.
- Use `RemoveProp` to remove the variable from the list of variables associated with the session when it is no longer needed.

Suppose you want to throw an exception from within a PBNI extension and the exception itself is also defined by the PBNI extension. You call the `IPB_Session NewObject` function to create an instance of the exception, causing the `PBX_CreateNonVisualObject` function to be called.

One way to set the value of the fields of the exception before the function returns in a thread-safe manner is to create a new object or structure to hold the exception information before calling `NewObject`. You can call `SetProp` to store the structure or the object in the current `IPB_Session`. When `PBX_CreateNonVisualObject` is called, you can call `GetProp` to get the structure or object to obtain the exception information, then call `RemoveProp` to remove the data you stored in the current session.

See also

[GetProp](#)

[RemoveProp](#)

7.6.114 SetSharedVarToNull

Description

Sets the value of the specified shared variable to null.

Syntax

```
SetSharedVarToNull(pbgroup group, pbfield fid)
```

Table 7.103:

Argument	Description
group	The group to which the shared variable belongs
fid	The field ID of the shared variable

Return value

None.

Examples

This example tests the `IsSharedVarNull` and `SetSharedVarToNull` functions:

```
curGroup = session -> GetCurrGroup();
cls = session -> GetClass(myobj);

fid = session -> GetSharedVarID(curGroup, "i_svar");
if (session -> IsSharedVarNull(curGroup, fid))
    session -> SetIntSharedVar(curGroup, fid, 1);
else
    session -> SetSharedVarToNull(curGroup, fid);
```

See also

[Get<type>SharedVar](#)

[GetSharedVarID](#)

[GetSharedVarType](#)

[IsSharedVarArray](#)

[IsSharedVarNull](#)

[IsSharedVarObject](#)

[Set<type>SharedVar](#)

7.6.115 SetString**Description**

Frees an existing string and assigns a new string value to it by performing a deep copy.

Syntax

```
SetString (pbstring string, LPCTSTR src)
```

Table 7.104:

Argument	Description
string	A valid pbstring variable whose value is to be replaced
src	The string to be assigned to string

Return value

PBXRESULT. Returns `PBX_OK` for success or `PBX_E_INVALID_ARGUMENT` if the new string value is invalid; otherwise, returns `PBX_E_OUTOF_MEMORY`.

Examples

This example uses the IPB_Session SetString method to set the ret_val string to the return value in the PBCallInfo structure. It also uses the IPB_Value SetPBString method to set values in PBCallInfo:

```
pbclass cls;
pbmethodID mid;
PBCallInfo* ci = new PBCallInfo;
pbstring ret_val;
LPCTSTR pStr;

cls= Session -> GetClass(myobj);
if (isAny)
    mid=Session-> GetMethodID(cls, "uf_any_byvalue",
        PBRT_FUNCTION, "AAAAA");
else
    mid=Session-> GetMethodID(cls, "uf_string_byvalue",
        PBRT_FUNCTION, "SSSSS");
Session-> InitCallInfo(cls, mid, ci);

ci-> pArgs -> GetAt(0) -> SetPBString(s_low);
ci-> pArgs -> GetAt(1) -> SetPBString(s_mid);
ci-> pArgs -> GetAt(2) -> SetPBString(s_high);
pStr = Session -> GetString(s_null);
if (pStr != 0)
{
    if (strcmp(pStr, "null") == 0 )
        ci-> pArgs -> GetAt(3) -> SetToNull();
    else
        ci-> pArgs -> GetAt(3) -> SetPBString(s_null);
}
Session -> InvokeObjectFunction(myobj, mid, ci);
ret_val = Session -> NewString("");
Session -> SetPBString(ret_val, Session->GetString
    (ci->returnValue->GetString()));
Session -> FreeCallInfo(ci);
delete ci;
return ret_val;
```

Usage

A deep copy is performed. The existing value is destroyed first, and then the contents of the src argument are copied into a new value.

See also

[NewString](#)

7.6.116 SetTime

Description

Resets the value of the specified pptime object.

Syntax

```
SetTime (pptime time, pbint hour, pbint minute, pbdouble second)
```

Table 7.105:

Argument	Description
time	The pptime object to be reset

Argument	Description
hour	An hour in the range 0 to 23
minute	A minute in the range 0 to 59
second	A second in the range 0 to 59.999999

Return value

PBX_RESULT. PBX_OK for success or PBX_E_INVALID_ARGUMENT if the new time is invalid.

Examples

This code puts a new time with the value 01:01:01 into the time_val property of the pArguments array if the value in the PBCallInfo structure is null. Otherwise it sets time_val to the time in the PBCallInfo structure:

```
if (ci->pArgs->GetAt(i)->IsNull())
{
    pArguments[i].time_val = Session-> NewTime();
    Session->SetTime(pArguments[i].time_val, 1, 1, 1);
                        // Time: 01:01:01
}
else
{
    pArguments[i].time_val =
        ci-> pArgs-> GetAt(i)-> GetTime();
}
```

Usage

If the parameters are invalid, the time is reset to 0:0:0.0.

See also

[NewTime](#)

[SplitTime](#)

7.6.117 SetValue

Description

Sets the value of one IPB_Value object to the value of another IPB_Value object.

Syntax

```
SetValue( IPB_Value* dest, IPB_Value* src)
```

Table 7.106:

Argument	Description
dest	The value to be replaced
src	The value to which dest is to be changed

Return value

None.

Examples

These statements set the return value in the PBCallInfo structure ci to the value IPBValue_ret, then release the IBPValue_ret structure:

```
Session -> SetValue(ci -> returnValue, IPBValue_ret);
Session -> ReleaseValue(IPBValue_ret);
```

Usage

Unlike the IPB_Value Set<type> methods, the SetValue method does not verify that the datatype of the replacement value matches the datatype of the original value. The original value is freed and a new value is cloned from the src value. Use this method if you want to swap two different IPB_Value objects that have different types.

See also

[AcquireValue](#)

[ReleaseValue](#)

7.6.118 SplitDate

Description

Splits the specified pbdate object into a year, month, and day.

Syntax

```
SplitDate (pbdate date, pbint *year, pbint *month, pbint *day)
```

Table 7.107:

Argument	Description
date	The pbdate object to be split
year	A year in the range 1000 to 3000
month	A month in the range 1 to 12
day	A day in the range 1 to 31

Return value

PBX_RESULT. PBX_OK for success.

Examples

This statement splits the date in the first value in the PBCallInfo structure:

```
Session -> SplitDate(ci-> pArgs -> GetAt(0) ->
    GetDate(), &yy, &mm, &dd);
```

See also

[NewDate](#)

[SetDate](#), [SplitDateTime](#)

7.6.119 SplitDateTime

Description

Splits the specified pbdatetime object into a year, month, day, hour, minute, and second.

Syntax

```
SplitDateTime(pbdatetime dt, pbint *year, pbint *month, pbint *day, pbint *hour,
pbint *minute, pbdouble *second)
```

Table 7.108:

Argument	Description
dt	The pbdatetime object to be split
year	A year in the range 1000 to 3000
month	A month in the range 1 to 12
day	A day in the range 1 to 31
hour	An hour in the range 0 to 23
minute	A minute in the range 0 to 59
second	A second in the range 0 to 59.999999

Return value

PBX_RESULT. PBX_OK for success.

See also

[NewDateTime](#)

[SetDateTime](#)

[SplitDate](#)

[SplitTime](#)

7.6.120 SplitTime

Description

Splits the specified time object into an hour, minute, and second.

Syntax

```
SplitTime(pptime time, pbint *hour, pbint *minute, pbdouble *second)
```

Table 7.109:

Argument	Description
time	The pptime object to be split
hour	An hour in the range 0 to 23
minute	A minute in the range 0 to 59
second	A second in the range 0 to 59.999999

Return value

PBX_RESULT. PBX_OK for success.

Examples

These statements split a time into hours, minutes, and seconds, and then use the resulting values to set the value of a new time object:

```
Session->SplitTime(ci.returnValue->GetTime(), &hh,
    &mm, &ss);
ret_val = Session-> NewTime();
Session-> SetTime(ret_val, hh, mm, ss);
```

See also

[NewTime](#)

[SetTime](#)

7.6.121 ThrowException

Description

Throws a PowerBuilder exception or inherited exception, and replaces the existing exception if there is one.

Syntax

```
ThrowException (pobject ex)
```

Table 7.110:

Argument	Description
ex	The exception to be thrown. The exception must first be created with NewObject.

Return value

None.

Examples

This code creates a new exception object in the class user_exception_pspp, invokes its SetMessage function, and throws the exception:

```
pbclass cls;
pbmethodID mid;
pobject ex;
pbgroup group;
PBCallInfo* ci = new PBCallInfo;

// Throw exception
group = session-> FindGroup("user_exception_pspp",
    pbgroup_userobject);
if (group==NULL)
    return;
cls = session->FindClass(group, "user_exception_pspp");
if (group==NULL)
    return;
ex = session -> NewObject(cls);
mid = session-> GetMethodID(cls,
    "setmessage", PBRT_FUNCTION, "QS");
session-> InitCallInfo(cls,mid,ci);
```

```

ci-> pArgs[0].SetPBString(session, "Test exception");

session -> InvokeObjectFunction(ex,mid,ci);
session -> ThrowException(ex);
if (!ThrowToPB)
    session -> ClearException();
session -> FreeCallInfo(ci);
delete ci;
return;

```

See also[ClearException](#)[GetException](#)[HasExceptionThrown](#)**7.6.122 TriggerEvent****Description**

Triggers a PowerBuilder event.

Syntax

```
TriggerEvent(pobject obj, pbmethodID mid, PBCallInfo *ci)
```

Table 7.111:

Argument	Description
obj	The pobject containing the method
mid	The pbMethodID returned by GetMethodID
ci	A pointer to a preallocated PBCallInfo structure

Return value

PBXRESULT. Returns PBX_OK for success, or one of the following for failure:

PBX_E_INVALID_ARGUMENT

PBX_E_INVOKE_METHOD_INACCESSABLE

PBX_E_INVOKE_WRONG_NUM_ARGS

PBX_E_INVOKE_REFARG_ERROR

PBX_E_INVOKE_METHOD_AMBIGUOUS

PBX_E_INVOKE_FAILURE

Examples

This code triggers the clicked event on a DataWindow object:

```

cls = session->GetClass(dwobj);
mid = session->GetMethodID
    (cls, "clicked", PBRT_EVENT, "LIILCdwindow.");
session->InitCallInfo(cls, mid, ci);
session->TriggerEvent(dwobj, mid, ci);
...

```

See also[GetClass](#)[GetMethodID](#)**7.6.123 UpdateField****Description**

Refreshes a visual property of a PowerBuilder object.

Syntax

```
UpdateField(pboobject obj, pbfieldID fid)
```

Table 7.112:

Argument	Description
obj	The pboobject whose user interface property needs to be changed
fid	The field ID of the object

Return value

PBXRESULT. Returns success or failure.

Examples

This function changes the title of a DataWindow control:

```
void Callback::f_newtitle(IPB_Session* session, pbstring str_val, pboobject dwobj)
{
    pbclass cls;
    pbfieldID fid;
    cls=session->GetClass(dwobj);
    fid=session->GetFieldID(cls, "title");
    if (fid==kUndefinedFieldID)
        return;
    session -> SetPBStringField(dwobj,fid,str_val);
    session -> UpdateField(dwobj,fid);
    return ;
}
```

Usage

When you change any visual property of a PowerBuilder object by calling Set<type>field functions, the property is changed but the property is not refreshed in the graphical user interface. UpdateField refreshes the visual properties of PowerBuilder objects. You must call this function explicitly when changing any visual property with the Set<type>field functions.

See also[Set<type>Field](#)**7.7 IPB_Value interface****Description**

The IPB_Arguments and IPB_Value interfaces pass values between the PowerBuilder VM and PowerBuilder extension modules. Through the IPB_Value interface, you can access information about each variable, including its type, null flag, access privileges, array or simple type, and reference type.

Methods

Table 7.113: IPB_Value methods

Method	Description
Get<type>	Set of datatype-specific methods that return a pointer to the data in IPB_Value
GetClass	Returns the class handle of a PowerBuilder object
GetType	Returns the datatype of a single data item or array
IsArray	Returns true if the IPB_Value instance contains an array, otherwise returns false
IsByRef	Returns true if the IPB_Value instance is passed by reference
IsEnum	Returns true if the IPB_Value instance contains a null value, otherwise returns false
IsObject	Returns true if the IPB_Value instance contains an object or object array, otherwise returns false
SetToNull	Used to set the data contained in the IPB_Value instance to null so that data can be reset
Set<type>	Set of datatype-specific methods that set the value of the IPB_Value instance

7.7.1 Get<type>

Description

A set of datatype-specific methods that return a pointer to the data in IPB_Value.

Syntax

```

GetArray ( )
GetBlob( )
GetBool ( )
GetByte ( )
GetChar ( )
GetDate ( )
GetDateTime( )
GetDecimal ( )
GetDouble ( )
GetInt ( )
GetLong( )
GetLongLong( )
GetObject ( )

```

```
GetReal( )  
GetString( )  
GetTime( )  
GetUInt( )  
GetULong( )
```

Return value

A predefined PBNI datatype that corresponds to the PowerBuilder datatype in the method name.

Examples

This statement gets the date in the first value in the PBCallInfo structure and splits it into year, month, and day:

```
Session -> SplitDate(ci-> pArgs -> GetAt(0) ->  
GetDate(), &yy, &mm, &dd);
```

Usage

If IPB_Value contains a null value, or if you are trying to get a specific datatype from an IPB_Value instance of another datatype, the data retrieved is undetermined. If the datatype is string, blob, decimal, time, date, datetime, array, or object, the return value points to the same address pointed to by IPB_Value. As a result, changing either the variable that holds the return value or the value of the IPB_Value instance affects the other.

See also

[Set<type>](#)

7.7.2 GetClass

Description

Returns the class handle of a PowerBuilder object.

Syntax

```
GetClass( )
```

Return value

pbclass or null on error.

Examples

```
pbclass clz = ci-> pArgs-> GetAt(i)-> GetClass();
```

See also

[Get<type>](#)

[GetType](#)

[Set<type>](#)

7.7.3 GetType

Description

Returns the datatype of a single data item or array.

Syntax

```
GetType()
```

Return value

pbuint

Examples

```
ArgsType = ci->pArgs->GetAt(i)->GetType();
switch (ArgsType)
{
case pbvalue_int:
if (ci->pArgs->GetAt(i)->IsNull())
pArguments[i].int_val=1;
else
pArguments[i].int_val =
ci->pArgs->GetAt(i)->GetInt();
break;
...
}
```

Usage

If the IPB_Value instance contains an object or structure, GetType returns the class ID of the data. Otherwise, it returns a simple datatype defined in the list of pbvalue_type enumerated types.

See also

[Get<type>](#)

[GetClass](#)

[Set<type>](#)

7.7.4 IsArray

Description

Returns true if the IPB_Value instance contains an array; otherwise, returns false.

Syntax

```
IsArray( )
```

Return value

pbboolean

Examples

This example tests whether an IPB_Value instance is an array before obtaining the array:

```
if(ci->pArgs->GetAt(i)->IsArray())
{
pArguments[i].array_val =
ci->pArgs->GetAt(i)->GetArray();
continue;
}
```

See also

[IsByRef](#)

[IsEnum](#)[IsObject](#)

7.7.5 IsByRef

Description

Returns true if the IPB_Value instance contains a by reference argument; otherwise it returns false.

Syntax

```
IsByRef ( )
```

Return value

pbboolean

Examples

This example shows how you would use IsByRef to test whether an argument is obtained by reference:

```
if (ci->pArgs->GetAt(i)->IsByRef())  
...
```

See also

[IsArray](#)[IsEnum](#)[IsObject](#)

7.7.6 IsEnum

Description

Returns true if the IPB_Value instance contains an enumerated value; otherwise it returns false.

Syntax

```
IsEnum ( )
```

Return value

pbboolean

See also

[GetEnumItemName](#)[GetEnumItemValue](#)

7.7.7 IsNull

Description

Returns true if the IPB_Value instance contains a null value; otherwise, it returns false.

Syntax

```
IsNull( )
```

Return value

pbboolean

Examples

This example tests whether an IPB_Value instance contains a null value before attempting to obtain its value:

```
if (ci->pArgs->GetAt(i)->IsObject())
{
if (ci->pArgs->GetAt(i)->IsNull())
pArguments[i].obj_val=0;
else
pArguments[i].obj_val =
ci->pArgs->GetAt(i)->GetObject();
continue;
}
...
```

See also

[IsArray](#)

[IsByRef](#)

[IsObject](#)

[SetToNull](#)

7.7.8 IsObject

Description

Returns true if the IPB_Value instance contains an object or object array; otherwise it returns false.

Syntax

```
IsObject( )
```

Return value

pbboolean

Examples

This example tests whether an IPB_Value instance contains an object before attempting to obtain the object:

```
if ( ci->pArgs->GetAt(i)->IsObject())
{
if (ci->pArgs->GetAt(i)->IsNull())
pArguments[i].obj_val = 0;
else
pArguments[i].obj_val =
ci->pArgs->GetAt(i)->GetObject();
continue;
}
...
```

See also

[IsArray](#)[IsByRef](#)[IsEnum](#)

7.7.9 Set<type>

Description

Set of datatype-specific methods that set the value of the IPB_Value instance.

Syntax

```

SetArray ( parray array )
SetBlob( pblob blob )
SetBool ( pbboolean boolean )
SetByte ( pbbyte byte )
SetChar ( pbchar char)
SetDate ( pbdate date )
SetDateTime( pbdatetime datetime)
SetDecimal ( pbdecimal dec)
SetDouble ( pbdouble double)
SetInt ( pbint int)
SetLong( pblong long )
SetLongLong( pblonglong longlong )
SetObject ( pbobject object)
SetPBString ( pbstring string)
SetReal( pbreal real )
SetString ( LPCTSTR string)
SetTime( pbtime time )
SetUint( pbuint uint)
SetUlong ( pbulong ulong )

```

Return value

PBXRESULT.

Examples

This example uses the IPB_Value SetPBString method to set values in PBCallInfo. It also uses the IPB_Session SetString method to set the ret_val string to the return value in the PBCallInfo structure:

```

pbclass cls;
pbmethodID mid;
PBCallInfo* ci = new PBCallInfo;
pbstring ret_val;
LPCTSTR pStr;

cls= Session -> GetClass(myobj);
if (isAny)
mid=Session-> GetMethodID(cls, "uf_any_byvalue",
PBRT_FUNCTION, "AAAAA");
else
mid=Session-> GetMethodID(cls, "uf_string_byvalue",
PBRT_FUNCTION, "SSSSS");
Session-> InitCallInfo(cls, mid, ci);

// Call IPB_Value SetPBString method
ci-> pArgs -> GetAt(0) -> SetPBString(s_low);
ci-> pArgs -> GetAt(1) -> SetPBString(s_mid);
ci-> pArgs -> GetAt(2) -> SetPBString(s_high);
pStr = Session -> GetString(s_null);

```

```

if (pStr != 0)
{
if (strcmp(pStr, "null") == 0 )
ci-> pArgs -> GetAt(3) -> SetToNull();
else
ci-> pArgs -> GetAt(3) -> SetPBString(s_null);
}

Session -> InvokeObjectFunction(myobj, mid, ci);
ret_val = Session -> NewString("");
// Call IPB_Session SetString method
Session -> SetString(ret_val, Session->GetString
(ci->returnValue->GetString()));
Session -> FreeCallInfo(ci);
delete ci;
return ret_val;

```

Usage

These methods automatically set the value of IPB_Value to not null and return an error if the datatype to be set does not match the existing datatype. The error code is PBX_E_MISMATCHED_DATA_TYPE. If the value is a read-only argument, it returns the error PBX_E_READONLY_ARGS. If the datatype is string or blob, a deep copy is performed. The existing value is destroyed first, and then the contents of the argument are copied into a new value.

See also

[Get<type>](#)

7.7.10 SetToNull

Description

Sets the data contained in the IPB_Value instance to null so the data can be reset.

Syntax

```
SetToNull( )
```

Return value

PBXRESULT. If the value is a read-only argument, the error PBX_E_READONLY_ARGS is returned.

Examples

This example shows the use of SetToNull when a null blob value is returned:

```

case pbvalue_blob:
pStr=(LPCTSTR)Session-> GetBlob(retVal.blob_val);
if (strncmp(pStr, "null", 4)==0 )
ci->returnValue->SetToNull();
else
ci->returnValue->SetBlob(retVal.blob_val);
break;
...

```

See also

[IsEnum](#)

7.8 IPB_VM interface

Description

The IPB_VM interface loads PowerBuilder applications in third-party applications and interoperates with the PowerBuilder virtual machine (PBVM).

Methods

IPB_VM has two methods:

[CreateSession](#)

[RunApplication](#)

7.8.1 CreateSession

Description

Creates an IPB_Session object that can be used to call PowerBuilder functions.

Syntax

```
CreateSession(LPCTSTR applicationName, LPCTSTR* libraryList, pbuint numLibs,
IPB_Session** session)
```

Table 7.114:

Argument	Description
applicationName	The name of the current application object in lowercase
libraryList	The library list of the PowerBuilder application that contains the objects and functions to be called
numLibs	The number of libraries in the library list
session	A pointer to IPB_Session*, which will return the current IPB_Session pointer after the call

Return value

PBXRESULT. PBX_OK for success.

Examples

This example creates an IPB_Session with the simple library list mydemo.pbl:

```
IPB_Session* session;
IPB_VM* vm = NULL;
fstream out;
ifstream in;
PBXRESULT ret;

HINSTANCE hinst=LoadLibrary("pbvm170.dll");
if ( hinst== NULL) return 0;

out<< "Loaded PowerBuilder VM successfully!"<<endl;

P_PB_GetVM getvm = (P_PB_GetVM)GetProcAddress
```

```

(hinst, "PB_GetVM");
if (getvm == NULL) return 0;

getvm(&vm);
if (vm == NULL) return 0;

static const char *liblist[] =
{
"mydemo.pbl"
};

ret= vm->CreateSession("mydemo", liblist, 1, &session);
if (ret != PBX_OK)
{
out << "Create session failed." << endl;
return 0;
}
out << "Create session succeeded!" <<endl;

```

See also[RunApplication](#)**7.8.2 RunApplication****Description**

Runs the specified application.

Syntax

```
RunApplication(LPCTSTR applicationName, LPCTSTR* libraryList, pbuint numLibs,
LPCTSTR commandLine, IPB_Session** session)
```

Table 7.115:

Argument	Description
applicationName	The name of the application object to be run, in lowercase
libraryList	The library list of the application
numLibs	The number of libraries in the library list
commandLine	Parameters to be passed to the application object
session	A pointer to IPB_Session*, which will return the current IPB_Session pointer after the call

Return value

PBXRESULT. PBX_OK for success.

Examples

This code fragment loads the PowerBuilder VM and runs an application called runapp that uses one library, runapp.pbd. It passes in a command line with two arguments:

```

LRESULT CALLBACK WndProc(HWND hWnd, UINT message, WPARAM wParam, LPARAM lParam)
{
LPCTSTR szHello = "Hello world";

```

```

// Provide command line parameters (employee ids)
// to be passed to the PowerBuilder application
LPCTSTR szcommandline = "102 110";

int wmId, wmEvent, ret;
PAINTSTRUCT ps;
HDC hdc;

switch (message)
{
case WM_CREATE:
{
hPBVMInst = ::LoadLibrary("pbvm170.dll");

P_PB_GetVM getvm = (P_PB_GetVM)
GetProcAddress(hPBVMInst, "PB_GetVM");

IPB_VM* vm = NULL;

getvm(&vm);

static const char *liblist [] =
{"runapp.pbd"};
vm->RunApplication("runapp", liblist, 1,
szcommandline, &session);
break;
}
}

```

See also[CreateSession](#)

7.9 IPBX_Marshaler interface

Description

The IPBX_Marshaler interface is used to invoke remote methods and convert PowerBuilder data formats to the user's communication protocol. A marshaler extension is a PowerBuilder extension that acts as the bridge between PowerBuilder and other components, such as EJBs, Java classes, CORBA objects, Web services, and so on.

Methods

Table 7.116: IPBX_Marshaler methods

Method	Description
Destroy	Destroys an instance of an object inherited from the IPBX_Marshaler structure
GetModuleHandle	Returns the handle of the PBX that contains the native class
InvokeRemoteMethod	Used in PowerBuilder marshaler native classes to call remote methods

7.9.1 Destroy

Description

Use the Destroy method to destroy instances of objects inherited from the IPBX_Marshaler structure.

Syntax

```
Destroy( )
```

Return value

None.

Examples

This code destroys the current instance of the SampleMarshaler structure:

```
void SampleMarshaler::Destroy()  
{  
    delete this;  
}
```

Usage

You must implement this method in the marshaler native class after creating an instance of a marshaler structure and invoking remote methods.

See also

[GetModuleHandle](#)

[InvokeRemoteMethod](#)

7.9.2 GetModuleHandle

Description

Returns the handle of the PBX that contains the native class. This method is required to allow the PowerBuilder VM to determine which PBXs can be unloaded.

Syntax

```
GetModuleHandle( )
```

Return value

pbulong

Examples

This code in the implementation of a marshaler class returns the handle of the PBX:

```
extern pbulong thisModuleHandle;  
pbulong SampleMarshaler::GetModuleHandle()  
{  
    return thisModuleHandle;  
}
```

The handle is set in the main module:

```
pbulong thisModuleHandle = 0;  
  
BOOL APIENTRY DllMain( HANDLE hModule,  
    DWORD ul_reason_for_call,  
    LPVOID lpReserved
```

```

)
{
thisModuleHandle = (pbulong)hModule;

switch (ul_reason_for_call)
{
case DLL_PROCESS_ATTACH:
case DLL_THREAD_ATTACH:
case DLL_THREAD_DETACH:
case DLL_PROCESS_DETACH:
break;
}
return TRUE;
}

```

Usage

You must implement this method in the marshaler native class.

See also

[Destroy](#)

[InvokeRemoteMethod](#)

7.9.3 InvokeRemoteMethod

Description

Used in PowerBuilder marshaler native classes to call remote methods.

Syntax

```
InvokeRemoteMethod(IPB_Session *session, pbproxyobject obj, LPCTSTR methodDesc,
PBCallInfo *ci)
```

Table 7.117:

Argument	Description
session	This IPB session
obj	The proxy object for the remote object
methodDesc	An arbitrary string stored as an alias name for the remote method in the proxy, for example: function int foo(int a) alias "This is a method in remote BizTalk"
ci	The parameters and return value setting for the call

Return value

PBXRESULT.PBX_OK if the call succeeded.

Examples

This example shows a header file for a sample marshaler class:

```
#include "sampleinclude.h"
#include <pbext.h>
```

```
class SampleMarshaler : public IPBX_Marshaler
{
private:
string d_mystring;
long d_mylong;

private:
void myMethod(string arg1);

public:
SampleMarshaler(
string myString,
long mylong
);
~SampleMarshaler();

virtual PBXRESULT InvokeRemoteMethod
(
IPB_Session* session,
pbproxyObject obj,
LPCTSTR methodDesc,
PBCallInfo* ci
);

virtual pbulong
GetModuleHandle();
virtual void Destroy();
};
```

The associated C++ implementation file contains code like this:

```
PBXRESULT SampleMarshaler::InvokeRemoteMethod
(
IPB_Session* session,
pbproxyObject obj,
LPCTSTR methodDesc,
PBCallInfo* ci
)
{
// method invocation
}
```

Usage

You must implement this method in the marshaler native class.

See also

[Destroy](#)

[GetModuleHandle](#)

7.10 IPBX_NonVisualObject interface

Description

The IPBX_NonVisualObject interface inherits from IPBX_UserObject and is the direct ancestor class of nonvisual PowerBuilder native classes.

Methods

IPBX_NonVisualObject inherits two methods from the [IPBX_UserObject interface](#): [Destroy](#) and [Invoke](#).

7.11 IPBX_UserObject interface

Description

The IPBX_UserObject interface is the ancestor class of the PowerBuilder native classes.

Methods

IPBX_UserObject has two methods: [Destroy](#) and [Invoke](#)

7.11.1 Destroy

Description

Destroys the current instance of a PowerBuilder native class that inherits from IPBX_UserObject.

Syntax

```
Destroy( )
```

Return value

None.

Examples

This example shows how you would call Destroy for the class MyPBNIClass:

```
void MyPBNIClass::Destroy()
{
delete this;
}
```

Usage

You must implement this method in the native class after creating an instance of the class and invoking remote methods.

See also

[Invoke](#)

7.11.2 Invoke

Description

Calls methods in PowerBuilder native classes.

Syntax

```
Invoke(IPB_Session * session, pobject obj, pbmethodID mid, PBCallInfo *ci)
```

Table 7.118:

Argument	Description
session	This IPB session
obj	The PowerBuilder extension object to be invoked
mid	The pbMethodID returned by GetMethodID

Argument	Description
ci	The parameters and return value setting for the call

Return value

PBXRESULT.PBX_OK for success.

Examples

In this example, the method invoked depends on the value (0, 1, or 2) of the method ID returned from the GetMethodID method:

```
PBXRESULT PBNIExt::Invoke
(
    IPB_Session* session,
    pobject      obj,
    pbmethodID   mid,
    PBCallInfo*  ci
)
{
    PBXRESULT result = PBX_OK;

    switch (mid)
    {
        case mFuncA:
            result = FuncA(session, obj, ci);
            break;
        case mFuncB:
            result = FuncB(session, obj, ci);
            break;
        case mFuncC:
            result = FuncC(session, obj, ci);
            break;
        default:
            result = PBX_E_INVOKE_FAILURE;
            break;
    }

    return PBX_OK;
}
```

See also

[GetMethodID](#)

7.12 IPBX_VisualObject interface

Description

The IPBX_VisualObject interface inherits from IPBX_UserObject and is the direct ancestor class of visual PowerBuilder native classes.

Methods

IPBX_VisualObject has three direct methods:

[CreateControl](#)

[GetEventID](#)

[GetWindowClassName](#)

IPBX_NonVisualObject inherits two methods from the [IPBX_UserObject interface](#):

[Destroy](#)

[Invoke](#)

7.12.1 CreateControl

Description

Creates a window control and returns its handle to the PowerBuilder VM.

Syntax

```
CreateControl(DWORD dwExStyle, LPCTSTR lpWindowName, DWORD dwStyle, int x, int y,
int nWidth, int nHeight, HWND hWndParent, HINSTANCE hInstance)
```

Table 7.119:

Argument	Description
dwExStyle	The extended window style
lpWindowName	The window name
dwStyle	The window style
x	The horizontal position of the window
y	The vertical position of the window
nWidth	The window's width
nHeight	The window's height
hWndParent	The handle of the parent or owner window
hInstance	The handle of the application instance

Return value

HWND.

Examples

This is part of a visual extension example available on the Apeon Web site:

```
LPCTSTR CVisualExt::GetWindowClassName()
{
return s_className;
}

HWND CVisualExt::CreateControl
(
DWORD dwExStyle, // extended window style
LPCTSTR lpWindowName, // window name
DWORD dwStyle, // window style
int x, // horizontal position of window
int y, // vertical position of window
int nWidth, // window width
int nHeight, // window height
HWND hWndParent, // handle to parent or owner window
HINSTANCE hInstance // handle to application instance
)
{
```

```

d_hwnd = CreateWindowEx(dwExStyle, s_className,
lpWindowName, dwStyle, x, y, nWidth, nHeight,
hwndParent, NULL, hInstance, NULL);

::SetWindowLong(d_hwnd, GWL_USERDATA, (LONG)this);

return d_hwnd;
}

```

Usage

The window must be registered before you call CreateControl.

See also

[GetEventID](#)

[GetWindowClassName](#)

7.12.2 GetEventID

Description

Returns the identifier of an event when the window's parent is notified that the event occurred.

Syntax

```
GetEventID(HWND hwnd, uint iMsg, WPARAM wParam, LPARAM lParam)
```

Table 7.120:

Argument	Description
hwnd	The handle of the parent window.
iMsg	The message sent to the parent.
wParam	<p>The word parameter of the message.</p> <p>For WM_COMMAND, the high-order word specifies:</p> <ul style="list-style-type: none"> • The notification code if the message is from a control • 1 if the message is from an accelerator • 0 if the message is from a menu. <p>The low-order word specifies the identifier of the control, accelerator, or menu.</p> <p>For WM_NOTIFY, this parameter contains the identifier of the control sending the message.</p>
lParam	<p>The long parameter of the message.</p> <p>For WM_COMMAND, this parameter contains the handle of the control sending</p>

Argument	Description
	<p>the message if the message is from a control. Otherwise, this parameter is null.</p> <p>For WM_NOTIFY, this parameter contains a pointer to a structure.</p>

Return value

Integer.

Examples

In this example, the GetEventID function returns the identifier PB_BNCLICKED if a WM_COMMAND message with the notification code BN_CLICKED was sent. It returns the identifier PB_ENCHANGE if a WM_NOTIFY message was sent; otherwise it returns PB_NULL.

```
TCHAR CVisualExt::s_className[] = "PBVisualExt";

LPCTSTR CVisualExt::GetWindowClassName()
{
return s_className;
}

HWND CVisualExt::CreateControl
(
DWORD dwExStyle, // extended window style
LPCTSTR lpWindowName, // window name
DWORD dwStyle, // window style
int x, // horizontal position of window
int y, // vertical position of window
int nWidth, // window width
int nHeight, // window height
HWND hWndParent, // handle of parent or owner window
HINSTANCE hInstance // handle of application instance
)
{
d_hwnd = CreateWindowEx(dwExStyle, s_className,
lpWindowName, dwStyle, x, y, nWidth, nHeight,
hWndParent, NULL, hInstance, NULL);

::SetWindowLong(d_hwnd, GWL_USERDATA, (LONG)this);

return d_hwnd;
}

int CVisualExt::GetEventID(
HWND hWnd, /* Handle of parent window */
UINT iMsg, /* Message sent to parent window*/
WPARAM wParam, /* Word parameter of message*/
LPARAM lParam /* Long parameter of message*/
)
{
if (iMsg == WM_COMMAND)
{
if ((HWND)lParam == d_hwnd)
{
switch(HIWORD(wParam))
{
case BN_CLICKED:
return PB_BNCLICKED;
}
}
}
}

```

```
break;
}
}
}

if (iMsg == WM_NOTIFY)
{
return PB_ENCHANGE;
}
return PB_NULL;
}
```

Usage

This function is used to process Windows messages, such as WM_COMMAND and WM_NOTIFY, that are sent to the parent of an object and not to the object itself. Such messages cannot be caught in the visual extension's window procedure. The PBVM calls GetEventID to process these messages.

If the message is mapped to a PowerBuilder event, GetEventID returns the event's identifier, for example PB_BNCLICKED, and the event is fired automatically. PowerBuilder event token identifiers are mapped to unsigned integer values in the pbevtid.h header file. The identifiers in pbevtid.h are associated with PowerBuilder event token names. For example, the identifier PB_BNCLICKED is associated with the token name pbm_bnclicked.

If the message is not mapped to an event, GetEventID returns the value PB_NULL and the message is discarded.

See also

[CreateControl](#)

[GetWindowClassName](#)

7.12.3 GetWindowClassName

Description

Returns the name of the window.

Syntax

```
GetWindowClassName()
```

Return value

LPCTSTR.

Examples

The string returned by GetWindowClassName is passed as an argument to the CreateControl method:

```
LPCTSTR CVisualExt::GetWindowClassName()
{
return s_className;
}
```

Usage

The window must be registered before you call GetWindowClassName.

See also[CreateControl](#)[GetEventID](#)**7.13 PBArrayInfo structure****Description**

PBArrayInfo is a C++ structure used to hold information about arrays.

Properties**Table 7.121: PBArrayInfo members**

Member	Type	Description
ArrayBound	Local struct declaration	Structure of type pblong containing the boundaries (upperBound, lowerBound) of a dimension.
BoundedArray	Enum data	Used in arrayType to identify that the array is a bounded array.
UnboundedArray	Enum data	Used in arrayType to identify that the array is an unbounded array.
arrayType	Enum type	Used in IPB_Session::GetArrayInfo to identify the datatype of the array. Do not set this variable manually.
valueType	puint	The datatype of array items. Set it to pbvalue_type if it is a simple type, or pobject if the item is a class or structure.
numDimensions	puint	Number of dimensions of the array. An unbounded array can have only one dimension. The lower bound is one.
bounds	ArrayBound[]	Array bounds declaration array, used in a bounded array.

7.14 PBCallInfo structure**Description**

PBCallInfo is a C++ structure used to hold arguments and return type information in function calls between PBNI and PowerBuilder.

Table 7.122: PBCallInfo members

Member	Type	Description
pArgs	IPB_Arguments*	Interface used to access arguments
returnValue	IPB_Value	Holds return data after the call
returnClass	pbclass	Holds return class after the call

7.15 PB_DateData structure

Description

The PB_DateData structure is used to pass data of type Date in the SetData function in the IPB_RSItemData interface.

Table 7.123: PB_DateData members

Field	Description
year	A short identifying the year
month	A short identifying the month
day	A short identifying the day
filler	A short used for structure alignment only

See also

[SetData](#)

7.16 PB_DateTimeData structure

Description

The PB_DateTimeData structure is used to pass data of type DateTime in the SetData function in the IPB_RSItemData interface.

Table 7.124: PB_DateTimeData members

Field	Description
date	A PB_DateData structure identifying the date
time	A PB_TimeData structure identifying the time

See also

[SetData](#)

7.17 PB_TimeData structure

Description

The PB_TimeData structure is used to pass data of type Time in the SetData function in the IPB_RSItemData interface.

Table 7.125: PB_DateData members

Field	Description
hour	A short identifying the hour
minute	A short identifying the minute
second	A short identifying the second
filler	A short used for structure alignment only

See also

[SetData](#)

7.18 PBX_DrawItemStruct structure**Description**

The PBX_DrawItemStruct structure contains the properties of an external visual control that you want to draw using the PBX_DrawVisualObject function.

Table 7.126: PBX_DrawItemStruct members

Field	Description
x	X coordinate of the visual control relative to its parent control (for example, the window that contains it).
y	Y coordinate of the visual control relative to its parent control.
width	Width of the visual control.
height	Height of the visual control.
objectName	The name of the visual object, for example: uo_1.
tag	Field to be used to pass any value at the user's discretion.
enabled	Whether the visual control is enabled. Possible values are true and false.
visible	Whether the visual control is visible. Possible values are true and false. In the development environment, PowerBuilder does not call the PBX_DrawVisualObject function if this field is set to false and the Design>Show Invisibles menu item is not selected.
borderstyle	Border style of the visual control. A value of the pborder_style enumerated variable. Possible values are: <ul style="list-style-type: none"> • 0 -- none • 1 -- shadowbox

Field	Description
	<ul style="list-style-type: none"> • 2 -- box • 5 -- lowered • 6 -- raised
backColor	Background color of the visual control. You can obtain the RGB value of the background color using the Windows API functions GetRValue, GetGValue, and GetBValue.

See also

[PBX DrawVisualObject](#)

7.19 PBArryAccessor template class**Description**

There are two versions of the PBArryAccessor template class. The first version is used to access the items in an array of a standard type. The second version is used to access items in a string array. The standard types are defined as ValueTypes in pbtraits.h and are pbint, pbuint, pbbyte, pblong, pblonglong, pbulong, pbboolean, pbreal, pbdouble, pbdec, pbdate, pbtime, pbdatetime, pbchar, pbblob, and pbstring.

PBArryAccessor has four methods:

[GetAt](#)

[IsNull](#)

[SetAt](#)

[SetToNull](#)

7.19.1 GetAt**Description**

Obtains the array item at the specified dimension.

Syntax

```
GetAt(pblong dim[ ])
```

Return value

ValueType (defined in pbtraits.h).

Table 7.127:

Argument	Description
dim	The dimension of the array item to be obtained

Examples

See [SetAt](#).

See also

[SetAt](#)

7.19.2 IsNull

Description

Returns true if the array item contains a null value, otherwise returns false.

Syntax

```
IsNull(pblong dim[ ])
```

Table 7.128:

Argument	Description
dim	The dimension of the array item to be tested

Return value

pbboolean.

See also

[GetAt](#)

[SetAt](#)

[SetToNull](#)

7.19.3 SetAt

Description

Sets the array item at the specified dimension.

Syntax

For arrays of a specified ValueType:

```
SetAt(pblong dim[ ], ValueType v)
```

For string arrays:

```
SetAt(pblong dim[ ], LPCTSTR string)
SetAt(pblong dim[ ], pbstring string)
```

Table 7.129:

Argument	Description
dim	The dimension of the array item to be set
v	A ValueType defined in pbtraits.h
string	A string of type pbstring or LPCTSTR

Return value

None.

Examples

This example shows the use of `GetAt` and `SetAt` in arrays of a type specified by a `ValueType`:

```
template < typename T, pbvalue_type I>
void ArrayCreator<T, I>::f_unbounded_simple_array(
IPB_Session* session,
ifstream in,
fstream out,
LPCSTR data_type)
{
pbarray out_array;
int i;
pblong dim[4], itemcount1, itemcount2;

T *iarg, oarg;

in >> itemcount1;
iarg = new T[itemcount1];
// Create unbounded integer array
{
PBUnboundedArrayCreator<I> ac(session);
out_array = ac.GetArray();
PBArrayAccessor<I> aa(session, out_array);
for(i=0; i<itemcount1; i++)
in >> iarg[i];
for (i=0; i<itemcount1; i++)
{
dim[0]=i+1;
aa.SetAt(dim, iarg[i]);
}
itemcount2 = session->GetArrayItemCount(out_array);
out << "The array item count is "<< itemcount2 <<
endl;
for (i=0; i<itemcount2; i++)
{
dim[0]=i+1;
oarg=aa.GetAt(dim);
if (oarg != iarg[i])
out << "*** ERROR"<< endl;
else
out << oarg << " ";
}
}
delete []iarg;
out << endl;
return;
}
```

See also

[GetAt](#)

7.19.4 SetToNull

Description

Sets the value of the specified array item to null.

Syntax

```
SetToNull(pblong dim[ ])
```

Table 7.130:

Argument	Description
dim	The dimension of the array item to be set

Return value

None.

See also

[GetAt](#)

[IsNull](#)

[SetAt](#)

7.20 PBoundedArrayCreator template class**Description**

There are two versions of the PBoundedArrayCreator template class. The first version is used to create a bounded array of a standard type. The standard types are defined as ValueTypes in pbtraits.h and are pbint, pbuint, pbbyte, pblong, pblonglong, pbulong, pbboolean, pbrreal, pbdouble, pbdec, pbdate, pbtime, pbdatetime, pbchar, pbblob, and pbstring. The second version is used to create a bounded array of strings.

Methods

PBoundedArrayCreator has two methods:

[GetArray](#)

[SetAt](#)

7.20.1 GetArray**Description**

Obtains an array that has been created.

Syntax

```
GetArray()
```

Return value

pbarray.

Examples

This example sets up an array, reads in values, and then obtains the values in the array:

```
LPCTSTR *ostr_a;
char **sp;
int i;
pbarray out_array;
arrayBounds* bounds;
pbuint dim1, dim2, current_dim;
pblong itemcount1, itemcount2;
PBXRESULT ret;
PBArrayInfo* ai;
pbstring *iarg, *oarg;
```

```

typedef PBBoundedArrayCreator<pbvalue_string>
BoundedStringArrayCreator;

in >> dim1;
// allocate memory for pointer bounds
bounds = (arrayBounds*)malloc(dim1*sizeof
(PBArrayInfo::ArrayBound));
bounds = new arrayBounds[dim1];
// read in lowerbound and upperbound for each dimension
// and calculate the array item count
itemcount1 = 1;
for (i=0;i<dim1;i++)
{
in >>bounds[i].lowerBound >> bounds[i].upperBound;
itemcount1 = itemcount1*
(bounds[i].upperBound - bounds[i].lowerBound +1);
}
sp = new char*[itemcount1];
ostr_a = new LPCTSTR[itemcount1];
iarg = new pbstring[itemcount1];
// Read in array items
for (i=0; i<itemcount1; i++)
{
sp[i] = new char[20];
in >> sp[i];
iarg[i]= session->NewString(sp[i]);
}
// create bounded simple array and set iarg[i] to it
{
BoundedStringArrayCreator ac(session, dim1, bounds);
current_dim = 1;
BoundedArrayItem<pbstring, pbvalue_string,
BoundedStringArrayCreator>::f_set_arrayitem
(session, ac, dim1, bounds, iarg, current_dim);
BoundedArrayItem<pbstring, pbvalue_string,
BoundedStringArrayCreator>::array_itemcount = 0;
out_array = ac.GetArray();
}

```

See also[SetAt](#)**7.20.2 SetAt****Description**

Sets a value or string to the array item at the specified dimension.

Syntax

For arrays of a specified ValueType:

```
SetAt(pblong dim[], ValueType v)
```

For string arrays:

```
SetAt(pblong dim[], LPCTSTR string)
SetAt(pblong dim[], pbstring string)
```

Table 7.131:

Argument	Description
dim	The dimension of the array item to be set

Argument	Description
v	A ValueType defined in pbtraits.h
string	A string of type pbstring or LPCTSTR

Return value

None.

Examples

This example shows the use of SetAt in arrays of a type specified by a ValueType:

```
// arguments:
// ac: class object of PBBoundedArrayCreator or
// PBBoundedObjectArrayCreator to set items into
// dimensions: array dimension, can be 1,2,3,...,n
// bounds: upper and lower bound for each dimension
// iarg: T type array to store the data value set
// into array creator ac
// current_dim: remember which dimension is looped into

template < typename T, pbvalue_type I, class C>
void BoundedArrayItem<T,I,C>::f_set_arrayitem
(IPB_Session* session, C& ac, pblong dimensions,
arrayBounds* bounds, T* iarg, int current_dim)
{
int i;
if (current_dim > dimensions)
return;
for(i= bounds[current_dim-1].lowerBound;
i<= bounds[current_dim-1].upperBound; i++)
{
if (current_dim == dimensions)
{
dim[current_dim-1]= i;
ac.SetAt(dim,iarg[array_itemcount]);
array_itemcount++;
}
else{
dim[current_dim-1]= i;
BoundedArrayItem<T,I,C>::f_set_arrayitem
(session, ac, dimensions, bounds, iarg,
current_dim+1);
}
}
}
```

See also

[GetArray](#)

7.21 PBBoundedObjectArrayCreator class

Description

The PBBoundedObjectArrayCreator class is used to create an object array.

Methods

PBBoundedObjectArrayCreator has two methods:

[GetArray](#)

[SetAt](#)

7.21.1 GetArray

Description

Obtains an array that has been created.

Syntax

```
GetArray()
```

Return value

pbarray.

Examples

This example sets the values in an array and then uses GetArray to obtain the array:

```
PBBoundedObjectArrayCreator<pbvalue_string>
ac(session);
for (i=0;i<itemcount1;i++)
{
ac.SetAt(i+1,iarg[i]);
}
out_array = ac.GetArray();
```

See also

[SetAt](#)

7.21.2 SetAt

Description

Sets the array item at the specified dimension.

Syntax

For arrays of a specified ValueType:

```
SetAt(pblong dim[], ValueType v)
```

For string arrays:

```
SetAt(pblong dim[], LPCTSTR string)
SetAt(pblong dim[], pbstring string)
```

Table 7.132:

Argument	Description
dim	The dimension of the array item to be set
v	A ValueType defined in pbtraits.h
string	A string of type pbstring or LPCTSTR

Return value

None.

Examples

This method is included in the example for [GetArray](#).

See also

[GetArray](#)

7.22 PObjectArrayAccessor class

Description

The PObjectArrayAccessor class is used to access the items in an object array.

Methods

PObjectArrayAccessor has two methods:

[GetAt](#)

[SetAt](#)

7.22.1 GetAt

Description

Obtains the array item at the specified dimension.

Syntax

```
GetAt(pblong dim[])
```

Return value

pobject.

Table 7.133:

Argument	Description
dim	The dimension of the array item to be set

Examples

This example shows the use of GetAt in an object array:

```
PObjectArrayAccessor aa(session, *array_val);
for (i=0;i<itemcount2;i++)
{
dim[0] = i+1;
oarg = aa.GetAt(dim);
cls = session->GetClass(oarg);
if( cls == NULL )
return;
fid = session->GetFieldID(cls, "text");
if ( fid == 0xffff)
return;
fid_pv = session->GetFieldAddress(oarg,fid);
mystr = fid_pv->GetString();
ostr_a[i] = session->GetString(mystr);
}
```

See also

[SetAt](#)

7.22.2 SetAt

Description

Sets the array item at the specified dimension.

Syntax

```
SetAt(pblong dim[], pbject obj)
```

Table 7.134:

Argument	Description
dim	The dimension of the array item to be set
obj	A valid object handle

Return value

None.

Examples

This example shows the use of SetAt in an object array:

```
PBObjectArrayAccessor aa(session,*array_val);
for (i=0;i<itemcount1;i++)
{
cls = session->FindClass(group,sp[i]);
if( cls == NULL )
return;
iarg = session->NewObject(cls);
session->ReferenceObject(iarg);
dim[0] = i+1;
aa.SetAt(dim, iarg);
fid = session->GetFieldID(cls, "text");
if ( fid == 0xffff )
return;
fid_pv = session->GetFieldAddress(iarg, fid);
mystr = fid_pv->GetString();
istr_a[i] = session->GetString(mystr);
}
```

See also

[GetAt](#)

7.23 PBUnboundedArrayCreator template class

Description

There are two versions of the PBUnboundedArrayCreator template class. The first version is used to create an unbounded array of a standard type. The standard types are defined as ValueTypes in ptraits.h and are pbit, pbyte, puint, pblong, pblonglong, pulong, pbboolean, pbreal, pbdouble, pbdec, pbdate, pbtime, pbdatetime, pbchar, pblob, and pbstring. The second version is used to create an unbounded array of strings.

Methods

PBUnboundedObjectArrayCreator has two methods:

[GetArray](#)

[SetAt](#)

7.23.1 GetArray

Description

Obtains an array that has been created.

Syntax

```
GetArray()
```

Return value

pbarray.

Examples

This example sets the values in an array and then uses GetArray to obtain the array:

```
PBUnboundedArrayCreator<pbvalue_string> ac(session);
for (i=0; i<itemcount1; i++)
{
    ac.SetAt(i+1,iarg[i]);
}
out_array = ac.GetArray();
```

See also

[SetAt](#)

7.23.2 SetAt

Description

Sets the array item at the specified position.

Syntax

For arrays of a specified ValueType:

```
SetAt(pblong pos, ValueType v)
```

For string arrays:

```
SetAt(pblong pos, LPCTSTR string)
SetAt(pblong pos, pbstring string)
```

Table 7.135:

Argument	Description
pos	A pblong identifying a position in the array
v	A ValueType defined in pbtraits.h
string	A string of type pbstring or LPCTSTR

Return value

None.

Examples

This example shows the use of `SetAt` in arrays of a type specified by a `ValueType`:

```
PBUnboundedArrayCreator<I> ac(session);
in >> iarg[i];
for (i=0; i<itemcount1; i++)
{
ac.SetAt(i+1, iarg[i]);
}
out_array = ac.GetArray();
```

See also

[GetArray](#)

7.24 PBUnboundedObjectArrayCreator class

Description

The `PBUnboundedObjectArrayCreator` class is used to create an object array.

Methods

`PBUnboundedObjectArrayCreator` has two methods:

[GetArray](#)

[SetAt](#)

7.24.1 GetArray

Description

Obtains an array that has been created.

Syntax

```
GetArray( )
```

Return value

pbarray.

See also

[SetAt](#)

7.24.2 SetAt

Description

Sets the array item at the specified dimension.

Syntax

For arrays of a specified `ValueType`:

```
SetAt( pblong pos, ValueType v )
```

For string arrays:

```
SetAt( pblong pos, LPCTSTR string )
SetAt( pblong pos, pbstring string )
```

Table 7.136:

Argument	Description
pos	A pblong identifying a position in the array
v	A ValueType defined in pbtraits.h
string	A string of type pbstring or LPCTSTR

Return value

None.

See also

[GetArray](#)

7.25 Exported methods

Description

The following table lists methods that must be implemented in the PowerBuilder extension module when the conditions shown in the table apply. The methods are described after the table. The PBX_GetVersion method is used by PowerBuilder to determine whether the compiler macro UNICODE or _UNICODE has been set. It is for internal use only.

Methods**Table 7.137: Methods that must be exported by all extensions**

Method	Required
PBX_CreateNonVisualObject	When the extension contains nonvisual native classes
PBX_CreateVisualObject	When the extension contains visual native classes
PBX_DrawVisualObject	When you want to be able to draw a visual representation of the visual object in the PowerBuilder development environment
PBX_GetDescription	In all extensions
PBX_InvokeGlobalFunction	When the extension contains global functions
PBX_Notify	When you need to initialize and uninitialize a session

7.25.1 PBX_CreateNonVisualObject

Description

Creates a new instance of a nonvisual PowerBuilder extension object.

Syntax

```
PBX_CreateNonVisualObject(IPB_Session* pbsession, pobject pobj, LPCTSTR xtraName,
IPBX_NonVisualObject **obj)
```

Table 7.138:

Argument	Description
pbsession	This IPB session
pobj	The name of a pobject corresponding to the PowerBuilder extension object to be created
xtraname	The name of the PowerBuilder native class in lowercase
obj	The PowerBuilder extension object to be created

Return value

PBXRESULT. PBX_OK for success.

Examples

In this example, the extension contains several classes. The object created depends on the string value of the class name passed in.

```
PBEXPORT PBXRESULT PBXCALL PBX_CreateNonVisualObject
(
IPB_Session* pbsession,
pobject pobj,
LPCTSTR xtraName,
IPBX_NonVisualObject **obj
)
{
PBXRESULT result = PBX_OK;

string cn(className);
if (cn.compare("class_a") == 0)
{
*obj = new class_a(pobj);
}
else if (cn.compare("class_b") == 0)
{
*obj = new class_b(pobj);
}
else if (cn.compare("class_c") == 0)
{
*obj = new class_b(pobj);
else{
*obj = NULL;
result = PBX_E_NO_SUCH_CLASS;
}

return PBX_OK;
};
```

Usage

You must implement this method in every PowerBuilder extension module that contains nonvisual classes. When you use the CREATE statement in PowerScript to create a new PowerBuilder extension object, the PBVM calls this method.

See also[PBX_GetDescription](#)**7.25.2 PBX_CreateVisualObject****Description**

Creates a new instance of a visual PowerBuilder extension object.

Syntax

```
PBX_CreateVisualObject(IPB_Session* pbsession, pobject pobj, LPCTSTR xtraName,
IPBX_NonVisualObject**obj)
```

Table 7.139:

Argument	Description
pbsession	This IPB session
pobj	The name of a pobject corresponding to the PowerBuilder extension object to be created
xtraname	The name of the PowerBuilder native class in lowercase
obj	The PowerBuilder extension object to be created

Return value

PBXRESULT. PBX_OK for success.

Examples

In this example the extension contains several classes. The object created depends on the string value of the class name passed in.

```
PBEXPORT PBXRESULT PBXCALL PBX_CreateVisualObject
(
IPB_Session* pbsession,
pobject pobj,
LPCTSTR className,
IPBX_VisualObject **obj
)
{
PBXRESULT result = PBX_OK;

string cn(className);
if (cn.compare("visualext") == 0)
{
*obj = new CVisualExt(pbsession, pobj);
}
else
{
*obj = NULL;
result = PBX_FAIL;
}
return PBX_OK;
};
```

Usage

You must implement this method in every PowerBuilder extension module that contains visual classes. When you use a visual extension in a PowerBuilder application, the PBVM calls this method.

See also

[PBX_GetDescription](#)

7.25.3 PBX_DrawVisualObject

Description

Draws a visual object in the PowerBuilder development environment.

Syntax

```
PBX_DrawVisualObject(HDC hDC, LPCTSTR className, const PBX_DrawItemStruct&
property)
```

Table 7.140:

Argument	Description
hDC	A handle to the device context of the object
classname	The name of the visual extension object to be drawn
property	A PBX_DrawItemStruct structure specifying the display properties of the object

Return value

PBXRESULT. The return value of this function is currently ignored.

Examples

This is an extension of a sample that is available on the PowerBuilder Code Samples Web site at <https://www.appeon.com/developers/library/code-samples-for-pb>. It draws a representation of a light-emitting diode (LED) and uses Microsoft Foundation Classes (MFC):

```
PBEXPORT PBXRESULT PBXCALL PBX_DrawVisualObject
(
HDC hDC,
LPCTSTR xtraName,
const PBX_DrawItemStruct& property
)
{
// If this PBX is dynamically linked against the MFC
// DLLs, any functions exported from this PBX that
// call into MFC must have the AFX_MANAGE_STATE macro
// added at the very beginning of the function.
AFX_MANAGE_STATE( AfxGetStaticModuleState() );

// Variables to hold the Led control and a pointer
// to Device Context
CLed *myLed;
CDC* pDC;

// The name must not contain uppercase letters
```

```

if ( strcmp( xtraName, "u_cpp_led" ) == 0 )
{
CRect rc( property.x, property.y, property.x +
property.width, property.y + property.height );
//Create a new LED
myLed = new CLed();
// Get the handle from the hDC
pDC = CDC::FromHandle(hDC);
CWnd* pWnd = pDC->GetWindow();
// Create the window
myLed->Create(NULL, WS_CHILD | WS_VISIBLE |
SS_BITMAP, rc, pWnd);

// Function that handles the background
// rendering of the control
myLed->OnEraseBkgndIDE(pDC);
// Draw the LED in default mode (red, on, round)
myLed->DrawLed(pDC,0,0,0);
myLed->SetLed(0,0,0);
//done
delete myLed;
}

return PBX_OK;
}

```

Usage

In a visual extension, export this function if you want the visual control to be drawn in the development environment. If you do not export the function, you need to run the application to see the appearance of the visual control.

See also

[PBX_CreateVisualObject](#)

[PBX_DrawItemStruct structure](#)

7.25.4 PBX_GetDescription

Description

Passes a description of all the classes and methods in the PowerBuilder extension module to PowerBuilder.

Syntax

```
PBX_GetDescription ( )
```

Return value

LPCTSTR containing the description of the module.

Examples

The following extension module contains three classes:

```

PBXEXPORT LPCTSTR PBXCALL PBX_GetDescription()
{
static const TCHAR desc[] = {
"class class_a from nonvisualobject\n"
"function long meth1(string classpath)\n"
"function string meth2()\n"
"end class\n"
}
}

```

```
"class class_b from nonvisualobject\n"
"subroutine sbtrl()\n"
"subroutine sbrt2()\n"
"function long func1()\n"
"end class\n"

"class class_c from nonvisualobject\n"
"end class\n"
};

return desc;
}
```

The following module contains a visual class that has two subroutines (functions that do not return values), two events that require that Windows messages be captured in the extension (onclick and ondoubleclick), and one event that maps a Windows message directly to a PowerBuilder event (testmouse). The module also contains two global functions, funca and funcb.

```
PBXEXPORT LPCTSTR PBXCALL PBX_GetDescription()
{
static const TCHAR desc[] = {
"class visualext from userobject\n"
"event int onclick()\n"
"event int ondoubleclick()\n"
"subroutine setcolor(int r, int g, int b)\n"
"subroutine settext(string txt)\n"
"event testmouse pbm_mousemove \n"
"end class\n"

"globalfunctions\n"
"function int funca(int a, int b)\n"
"function int funcb(int a, int b)\n"
"end globalfunctions\n"
};

return desc;
}
```

Usage

You must implement this method in every PowerBuilder extension module. The method is exported from the PowerBuilder extension module and is used by PowerBuilder to display the prototype of each class, function, and event in the module.

The syntax of the description follows:

Multiple instances

A syntax element with an asterisk indicates that multiple instances of that element can appear in a description. For example, [Desc]* indicates that one description can contain multiple classes, global functions, and forward declarations.

```
Desc ::=
class_desc | globalfunc_desc | forward_desc | [Desc]*
class_desc ::=
class className from parentClass newline
[method_desc]* end class newline
globalfunc_desc ::=
globalfunctions newLine [func_desc]* end globalfunctions
```



```

forward_desc:=
forward newLine [forwardtype_desc]* end forward
forwardtype_desc:=
class className from parentClass newline
className::=
a PowerBuilder token (cannot duplicate an existing group name)
parentClass::=
any class inherited from NonVisualObject or UserObject
newline ::=
a newline character
methods_desc::=
method_desc [methods_desc]*
method_desc::=
func_desc | sub_desc | event_desc
func_desc::=
function returnType funcName(args_desc) newline
returnType ::= =
pbType
pbType::=
any PowerBuilder type | previous declared PBNI class
funcName::=
a PowerBuilder token
args_desc::=
None | arg_desc, [args_desc]*
arg_desc::=
[ ref | readonly ] pbType argName [array_desc]
argName::=
a PowerBuilder token
array_desc::=
array declaration of PowerBuilder
sub_desc::=
subroutine subName(args_desc) newline
event_desc::=
event returnType eventName(args_desc) newline
| event eventName pbevent_token newline
pbevent_token ::= =
string

```

This syntax for event_desc allows you to map a Windows message directly to a PowerBuilder event:

```
event eventName pbevent_tokennewline
```

For more information, see [Event processing in visual extensions](#).

See also

[PBX_CreateNonVisualObject](#)

[PBX_CreateVisualObject](#)

[PBX_InvokeGlobalFunction](#)

7.25.5 PBX_InvokeGlobalFunction

Description

Contains the implementation of one or more global functions used in the PowerBuilder extension module.

Syntax

```
PBX_InvokeGlobalFunction(IPB_Session* pbsession, LPCTSTR functionname, PBCallinfo* ci);
```

Table 7.141:

Argument	Description
pbsession	This IPB session
functionname	The name of the global function
ci	A pointer to a preallocated PBCallInfo structure containing the parameters and return value setting for the function

Return value

PBXRESULT. PBX_OK for success.

Examples

This PBX_GetDescription call declares three global functions: bitAnd, bitOr, and bitXor:

```
PBXEXPORT LPCTSTR PBXCALL PBX_GetDescription()
{
static const TCHAR desc[] = {
"globalfunctions\n"
"function int bitAnd(int a, int b)\n"
"function int bitOr(int a, int b)\n"
"function int bitXor(int a, int b)\n"
"end globalfunctions\n"
};

return desc;
}
```

The PBX_InvokeGlobalFunction call contains the implementation of the functions:

```
PBXEXPORT PBXRESULT PBXCALL PBX_InvokeGlobalFunction
(
IPB_Session* pbsession,
LPCTSTR functionName,
PBCallInfo* ci
)
{
PBXRESULT pbrResult = PBX_OK;

int arg1 = ci->pArgs->GetAt(0)->GetInt();
int arg2 = ci->pArgs->GetAt(1)->GetInt();

if (strcmp(functionName, "bitand") == 0)
{
ci->returnValue->SetInt(arg1 & arg2);
}else if (strcmp(functionName, "bitor") == 0)
{
ci->returnValue->SetInt(arg1 | arg2);
}else if (strcmp(functionName, "bitxor") == 0)
{
ci->returnValue->SetInt(arg1 ^ arg2);
}else{
return PBX_FAIL;
}

return pbrResult;
}
```

Usage

Use this function in a PowerBuilder native class that uses global functions. The function is exported from the PowerBuilder extension module and is used to identify global functions included in the module. Like global functions in PowerScript, global functions in PowerBuilder extensions cannot be overloaded.

See also

[PBX_GetDescription](#)

7.25.6 PBX_Notify

Description

Used to initialize and uninitialize a session.

Syntax

```
PBXEXPORT PBXRESULT PBXCALL PBX_Notify(IPB_Session* pbsession, pbint reasonForCall)
```

Return value

PBXRESULT

Examples

This sample shows code that exports PBX_Notify and displays a message box after the PBX is loaded and before it is unloaded:

```
PBXEXPORT PBXRESULT PBXCALL PBX_Notify
(
IPB_Session* pbsession,
pbint      reasonForCall
)
{
switch(reasonForCall)
{
case kAfterDllLoaded:
MessageBox(NULL, "After PBX loading", "",
MB_OK);
break;
case kBeforeDllUnloaded:
MessageBox(NULL, "Before PBX unloading", "",
MB_OK);
break;
}
return PBX_OK;
}
```

Usage

If PBX_NOTIFY is exported, the PBVM calls PBX_Notify immediately after an extension PBX is loaded and just before the PBX is unloaded. You can use this function to initialize and uninitialize a session. For example, you could create a session manager object, and store it in the IPB session using the SetProp function. Later, you could use GetProp to obtain the session object.

7.26 Method exported by PowerBuilder VM

Description

This method is exported by the PowerBuilder VM:

[PB_GetVM](#)**7.26.1 PB_GetVM****Description**

Passes the IPB_VM interface to the user.

Syntax

```
PB_GetVM (IPB_VM** vm)
```

Examples

This example loads the PowerBuilder VM and calls the f_getrowcount function on the nvo_dw custom class user object:

```
#include <pbext.h>
#include <iostream.h>
typedef PBXEXPORT PBXRESULT (*P_PB_GetVM)(IPB_VM** vm);

class LibraryLoader
{
public:
LibraryLoader(LPCSTR libname)
{
d_hinst = LoadLibrary(libname);
}

~LibraryLoader()
{
FreeLibrary(d_hinst);
}

operator HINSTANCE()
{
return d_hinst;
}

private:
HINSTANCE d_hinst;
};

int main()
{
int int_rowcount;
PBXRESULT ret;
LibraryLoader loader("pbvm170.dll");
if ((HINSTANCE)loader == NULL) return 0;

P_PB_GetVM getvm = (P_PB_GetVM)
GetProcAddress((HINSTANCE)loader, "PB_GetVM");
if (getvm == NULL) return 0;

IPB_VM* vm = NULL;
getvm(&vm);
if (vm == NULL) return 0;
static const char *liblist[] =
{
"load_pbvm.pbl"
};

IPB_Session* session = NULL;
ret = vm->CreateSession
```

```
("load_pbvm", liblist, 1, &session);  
if (ret!= PBX_OK)  
{  
cout << " Create session failure!" << endl;  
return 0;  
}  
return 1;  
}
```

Usage

To load the PowerBuilder VM and run a PowerBuilder application in a third-party server or application, you first create an IPB_VM object using the PB_GetVM method. Then, create an IPB_Session object within IPB_VM, using the application's name and library list as arguments.

See also

[CreateSession](#)

8 PBNI Tool Reference

About this chapter

This chapter describes two tools provided with the PBNI SDK:

- The pbsig170 tool gets the internal signature of a PowerBuilder function from a PBL name.
- The pbx2pbd170 tool generates a PBD from a PBX.

When you install PowerBuilder, these tools are installed in the SDK subdirectory of your PowerBuilder 2017 R2 directory and in Shared\PowerBuilder.

8.1 pbsig170

Description

The PowerBuilder function signature is the internal signature of a PowerBuilder function that is used to identify polymorphisms functions in a class. The pbsig170 tool obtains these function signatures from a PBL.

Inherited functions

You can also obtain a signature by selecting the function in the System Tree or Browser and selecting Properties from its pop-up menu. The pbsig170 tool does not report the signature of functions that are inherited from an ancestor object unless they are extended in the descendant. For such functions, you must use the Properties dialog box to obtain the signature. The Properties dialog box in the Browser also allows you to obtain the signature of PowerBuilder system functions.

Syntax

```
pbsig170 pbl_name
```

Examples

This command extracts function signatures from one of the PBLs in the Code Examples sample application:

```
pbsig170 pbexamw1.pbl
```

Here is some of the output from the previous command:

```
PB Object Name: w_date_sort
  public subroutine of_sort (string as_Column,
    string as_Order)
    /* QSS */

PB Object Name: w_date_window
  public function boolean of_is_leap_year
    (integer ai_year)
    /* BI */

  public subroutine of_days ()
    /* Q */
```

```

PB Object Name: w_dde_server
  public subroutine check_hotlink (checkbox status,
    string data, string item)
    /* QCcheckbox.SS */

PB Object Name: w_dir_tree
public function integer
  wf_collapse_rows (datawindow
    adw_datawindow, long al_startrow)
    /* ICdatawindow.L */
  public function long of_recurse_dir_list (string
    as_path, long al_parent)
    /* LSL */
  public function string of_build_dw_tree
    (long al_handle)
    /* SL */

```

The following example illustrates the use of a letter code to represent a PowerBuilder system class or a custom class. Consider this function:

```
function integer of_get_all_sales_orders (Ref s_sales_order astr_order[], date
  adt_date, integer ai_direction)
```

For this function, the pbsig170 tool returns the following string. The first argument is an unbounded array of type s_sales_order and is passed by reference:

```
/* IRCs_sales_order.[ ]YI */
```

Usage

The pbsig170 tool generates a string that represents the declaration and signature of all the functions and events in the PBL, including argument types, return types, and passing style. Each function and event is followed by a commented string. You pass the commented string, for example, QSS in the first comment in the previous example, as the last argument to the GetMethodID method.

For example, the following output indicates that the function returns an integer and has a single integer argument passed by reference:

```
/* IRI */
```

PowerBuilder arrays

PowerBuilder arrays are indicated with a pair of square brackets [] as a suffix. For bounded arrays, the brackets enclose the bounds.

```
/* IRCdatastore.RS[ ]SS */
```

PowerBuilder system or custom class

Additional letter codes represent a PowerBuilder system class or a custom class. The letter C followed by the name of a PowerBuilder object or enumerated class and a period (Cname.) represents an argument or return value of that type.

The following table shows how the output from pbsig170 maps to datatypes and other entities.

Table 8.1: Return value and argument representation in pbsig170 output

Output	Datatype
[]	array

Output	Datatype
A	any
B	boolean
C	class
D	double
E	byte
F	real
G	basictype
H	character
I	integer
J	cursor
K	longlong
L	long
M	decimal
N	unsigned integer (uint)
O	blob
P	dbproc
Q	No type (subroutine)
S	string
T	time
U	unsigned long (ulong)
W	datetime
Y	date
Z	objhandle

The passing style is indicated by a prefix on the type.

Table 8.2: Passing style and varargs representation in pbsig170 output

Prefix	Meaning
None	Pass by value
R	Pass by reference
X	Pass as read only
V	Variable arguments (varargs)

8.2 pbx2pbd170

Description

The pbx2pbd170 tool generates a PowerBuilder dynamic library (PBD) file from a PowerBuilder extension PBX. The generated PBD can be added to the library list of any

PowerBuilder application target that will use the objects and methods in the PowerBuilder extension.

Syntax

```
pbx2pbd170 [+] des.pbd src1.pbx [ src2.pbx src3.pbx ...srcn.pbx ]
```

Examples

This example generates a new PBD test.pbd from test.pbx. The input and output files are in the current directory:

```
pbx2pbd170 test.pbd test.pbx
```

This example appends generated information from C:\myproject\src.pbx to C:\mypbds\des.pbd. (If des.pbd does not exist, it is created.)

```
pbx2pbd170 + C:\mypbds\des.pbd C:\myproject\src.pbx
```

This example generates a new PBD D:\pbds\test.pbd from all the PBX files in the C:\myproject directory:

```
pbx2pbd170 D:\pbds\test.pbd C:\myproject\*.pbx
```

This example generates PBD information from all the PBX files in the C:\temp and D:\temp directories and appends the information to the existing generated PBD file D:\pbds\test.pbd:

```
pbx2pbd170 + D:\pbds\test.pbd c:\temp\*.pbx d:\temp\*.pbx
```

Usage

You can import an extension into a PowerBuilder library using the Import PB Extension pop-up menu item for the library in the PowerBuilder System Tree. Prior to PowerBuilder 11.5, you had to use the pbx2pbdnnn tool to create a PBD file from a PBX file, then add the PBD to the library list of your PowerScript target. The tool is still available in this release.

You can include multiple PBXs in a single PBD file. If you want to add additional PBXs to an existing PBD, use the plus (+) sign before the name of the PBD.

The pbx2pbd170 tool is installed in the system PATH in the Shared\PowerBuilder directory so you can invoke it in the directory where the PBXs reside.

If you specify an absolute path for the PBX file when you generate the PBD, the PowerBuilder application searches for the PBX only in the specified path.

If you do not specify the path for the PBX file, the PowerBuilder application searches the system path for the PBX.

Part III. Appendix

This appendix describes wizards provided for Microsoft Visual Studio.

9 APPENDIX A Using the Visual Studio Wizards

About this appendix

If you use Visual Studio .NET 2002 or 2003 or Visual Studio 2005, you can use a wizard to create a PBNI extension project. The wizard creates a project with .cpp and .h files that contain required code as well as template code to help you get started.

Check for wizard updates in the PBNI section of the PowerBuilder Code Samples Web site at <https://www.appeon.com/developers/library/code-samples-for-pb>.

9.1 Where the wizards are installed

When you install PowerBuilder, the setup program installs four directories into the PowerBuilder 17.0\SDK\PBNI\wizards directory:

- VCProjects 7.0
- VCProjects 7.1
- VCProjects 8.0
- VCWizards

If Microsoft Visual Studio is already installed on your computer, the setup program also installs the appropriate files into your Visual Studio installation.

Table A-1: Where wizard files are installed

Table 9.1:

Visual Studio version	Files copied	Destination
Visual Studio 2005	VCProjects 8.0 VCWizards	..\Microsoft Visual Studio 8\VC\VCProjects ..\Microsoft Visual Studio 8\VC\VCWizards
Visual Studio .NET 2003	VCProjects 7.1 VCWizards	..\Microsoft Visual Studio .NET 2003\Vc7\VCProjects ..\Microsoft Visual Studio .NET 2003\Vc7\VCWizards
Visual Studio .NET 2002	VCProjects 7.0 VCWizards	..\Microsoft Visual Studio .NET\Vc7\VCProjects ..\Microsoft Visual Studio .NET Vc7\VCWizards

If Visual Studio is not already installed when you install PowerBuilder, see the install.txt file in the PBNI\wizards\VCWizards\PBNIWizard directory for how to install the wizard later.

To check whether the wizard is installed in Visual Studio, select File>New>Project from the menu bar, select Visual C++ Projects, and scroll the Templates pane to see the PBNI wizard.

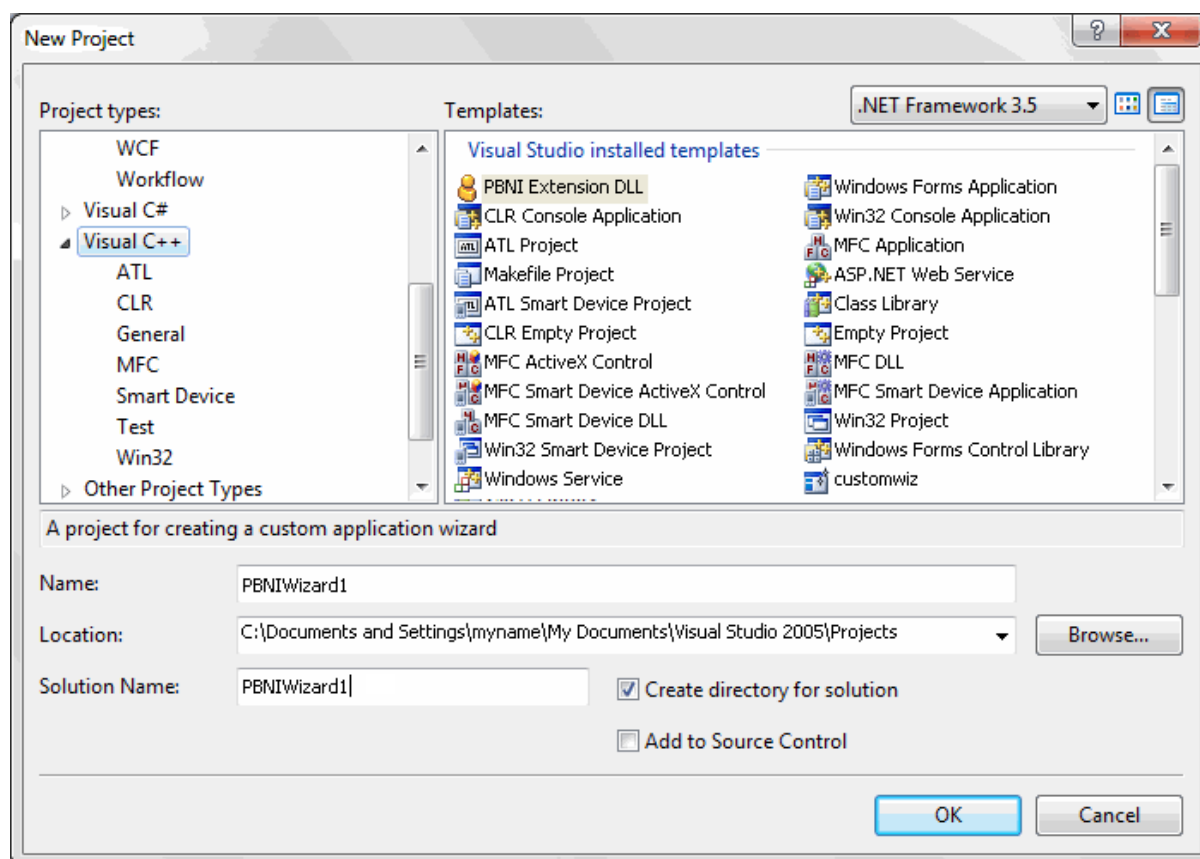

9.1.1 Generating a PBNI project

The PBNI Application Wizard lets you choose whether to create a visual or nonvisual extension, whether to include support for Unicode and global functions, and whether to generate a header file.

To create a new PBNI project:

1. Start Visual Studio, select File>New>Project, select Visual C++ Projects, and scroll the Templates pane to see the PBNI wizard.
2. Select PBNI Extension DLL, enter a name and location for the project, and click OK.
3. Click Application Settings if you want to create a visual extension or change any other settings.

The default is to create a nonvisual extension with Unicode support.

4. Click Finish.

See the ReadMe.txt file created by the wizard for a description of the generated source and header files.

9.1.2 Setting project options

If the project does not build correctly, you might need to turn off precompiled headers in the project's Property Pages dialog box and set the path for the PBNI include files.

To set project options for PBNI library and include files:

1. In Visual Studio, select Tools>Options.
2. Select Projects and Solutions>VC++ Directories.
3. Select Include Files from the Show Directories For drop-down list and click the New icon. Then click the browse button, browse to the location of the PowerBuilder 17.0\SDK\PBNI\include directory, and click OK.
4. Click OK to close the Options dialog box.

By default, the project is compiled for Unicode character sets. You can change this setting in the wizard. If you want to change it to compile for ASCII (SBCS) character sets after you have created the project, you can remove the `_UNICODE` preprocessor option.

To compile for ASCII character sets:

1. Select Project>ProjectName Properties.
2. Expand C/C++ and select Preprocessor.
3. Edit the Preprocessor Definitions to remove `_UNICODE` and `UNICODE`.

9.1.3 Building and using the PBX

When you have finished coding the project, build the project from the Build menu to create a DLL with the extension `.pbx`. By default, the extension is created in the Debug directory.

Then, you can import the PBX into a PBL in your PowerBuilder target and use it as described in [Using the extension](#).

Index

A

AcquireArrayItemValue, [80](#)
 AcquireValue, [81](#)
 Add<type>Argument, [82](#)
 AddGlobalRef, [84](#)
 AddLocalRef, [84](#)
 AddRef, [68](#)

C

C++, [47](#)
 call PowerBuilder from C++, [47](#)
 ClearException, [85](#)
 CreateControl, [191](#)
 CreateResultSet, [85](#)
 CreateSession, [183](#)

D

Destroy (IPBX_Marshaler), [185](#)
 Destroy (IPBX_UserObject), [189](#)

E

enumerated types, [45](#), [60](#)
 event processing, [24](#)

F

FindClass, [88](#)
 FindClassByClassID, [88](#)
 FindGroup, [89](#)
 FindMatchingFunction, [89](#)
 FreeCallInfo, [91](#)

G

Get<type>, [176](#)
 Get<type>ArrayItem, [91](#)
 Get<type>Field, [93](#)
 Get<type>GlobalVar, [94](#)
 Get<type>SharedVar, [95](#)
 GetArray (PBBoundedArrayCreator), [201](#)
 GetArray (PBBoundedObjectArrayCreator), [204](#)
 GetArray (PBUnboundedArrayCreator), [207](#)
 GetArray (PBUnboundedObjectArrayCreator), [208](#)
 GetArrayInfo, [96](#)
 GetArrayItemType, [97](#)
 GetArrayLength, [98](#)
 GetAt (IPB_Arguments), [66](#)

GetAt (PBArryAccessor), [198](#)
 GetAt (PBOBJECTArrayAccessor), [205](#)
 GetBlob, [99](#)
 GetBlobLength, [99](#)
 GetClass (IPB_Session), [100](#)
 GetClass (IPB_Value), [177](#)
 GetClassName, [101](#)
 GetColumnCount, [68](#)
 GetColumnMetaData, [68](#)
 GetCount (IPB_Arguments), [67](#)
 GetCurrGroup, [101](#)
 GetDateString, [102](#)
 GetDateTimeString, [102](#)
 GetDecimalString, [103](#)
 GetEnumItemName, [104](#)
 GetEnumItemValue, [104](#)
 GetEventID, [192](#)
 GetException, [105](#)
 GetFieldID, [105](#)
 GetFieldName, [106](#)
 GetFieldType, [107](#)
 GetGlobalVarID, [108](#)
 GetGlobalVarType, [108](#)
 GetItemData, [69](#)
 GetMarshaler, [109](#)
 GetMethodID, [110](#)
 GetMethodIDByEventID, [111](#)
 GetModuleHandle (IPBX_Marshaler), [186](#)
 GetNativeInterface, [112](#)
 GetNumOfFields, [113](#)
 GetPBAnyArrayItem, [113](#)
 GetPBAnyField, [114](#)
 GetPBAnyGlobalVar, [116](#)
 GetPBAnySharedVar, [116](#)
 GetProp, [117](#)
 GetResultSetAccessor, [117](#)
 GetRowCount, [70](#)
 GetSharedVarID, [118](#)
 GetSharedVarType, [119](#)
 GetString, [120](#)
 GetStringLength, [121](#)
 GetSuperClass, [121](#)
 GetSystemClass, [122](#)
 GetSystemGroup, [122](#)
 GetTimeString, [123](#)
 GetType, [177](#)
 GetWindowClassName, [194](#)

H

HasExceptionThrown, [123](#)
 HasPBVisualObject, [124](#)
 header files, [63](#)

I

InitCallInfo, [125](#)
 Invoke (IPBX_UserObject), [189](#)
 InvokeClassFunction, [126](#)
 InvokeObjectFunction, [127](#)
 InvokeRemoteMethod (IPBX_Marshaler),
[187](#)
 IPBX_Marshaler
 Destroy, [185](#)
 GetModuleHandle, [186](#)
 InvokeRemoteMethod, [187](#)
 IPBX_NonVisualObject, [188](#)
 IPBX_UserObject
 Destroy, [189](#)
 Invoke, [189](#)
 IPBX_VisualObject
 CreateControl, [191](#)
 GetEventID, [192](#)
 GetWindowClassName, [194](#)
 IPB_Arguments
 GetAt, [66](#)
 GetCount, [67](#)
 IPB_Arguments interface, [39](#)
 IPB_ResultSetAccessor
 AddRef, [68](#)
 GetColumnCount, [68](#)
 GetColumnMetaData, [68](#)
 GetItemData, [69](#)
 GetRowCount, [70](#)
 Release, [71](#)
 IPB_RSItemData
 SetData, [71](#)
 SetNull, [72](#)
 IPB_Session
 AcquireArrayItemValue, [80](#)
 AcquireValue, [81](#)
 Add<type>Argument, [82](#)
 AddGlobalRef, [84](#)
 AddLocalRef, [84](#)
 ClearException, [85](#)
 CreateResultSet, [85](#)
 FindClass, [88](#)
 FindClassByClassID, [88](#)

FindGroup, [89](#)
 FindMatchingFunction, [89](#)
 FreeCallInfo, [91](#)
 Get<type>ArrayItem, [91](#)
 Get<type>Field, [93](#)
 Get<type>GlobalVar, [94](#)
 Get<type>SharedVar, [95](#)
 GetArrayInfo, [96](#)
 GetArrayItemType, [97](#)
 GetArrayLength, [98](#)
 GetBlob, [99](#)
 GetBlobLength, [99](#)
 GetClass, [100](#)
 GetClassName, [101](#)
 GetCurrGroup, [101](#)
 GetDateString, [102](#)
 GetDateTimeString, [102](#)
 GetDecimalString, [103](#)
 GetEnumItemName, [104](#)
 GetEnumItemValue, [104](#)
 GetException, [105](#)
 GetFieldID, [105](#)
 GetFieldName, [106](#)
 GetFieldType, [107](#)
 GetGlobalVarID, [108](#)
 GetGlobalVarType, [108](#)
 GetMarshaler, [109](#)
 GetMethodID, [110](#)
 GetMethodIDByEventID, [111](#)
 GetNativeInterface, [112](#)
 GetNumOfFields, [113](#)
 GetPBAnyArrayItem, [113](#)
 GetPBAnyField, [114](#)
 GetPBAnyGlobalVar, [116](#)
 GetPBAnySharedVar, [116](#)
 GetProp, [117](#)
 GetResultSetAccessor, [117](#)
 GetSharedVarID, [118](#)
 GetSharedVarType, [119](#)
 GetString, [120](#)
 GetStringLength, [121](#)
 GetSuperClass, [121](#)
 GetSystemClass, [122](#)
 GetSystemGroup, [122](#)
 GetTimeString, [123](#)
 HasExceptionThrown, [123](#)
 HasPBVisualObject, [124](#)
 InitCallInfo, [125](#)

- [InvokeClassFunction, 126](#)
- [InvokeObjectFunction, 127](#)
- [IsArrayItemNull, 128](#)
- [IsAutoInstantiate, 128](#)
- [IsFieldArray, 129](#)
- [IsFieldNull, 129](#)
- [IsFieldObject, 130](#)
- [IsGlobalVarArray, 131](#)
- [IsGlobalVarNull, 132](#)
- [IsGlobalVarObject, 132](#)
- [IsNativeObject, 133](#)
- [IsSharedVarArray, 134](#)
- [IsSharedVarNull, 135](#)
- [IsSharedVarObject, 135](#)
- [NewBlob, 136](#)
- [NewBoundedObjectArray, 137](#)
- [NewBoundedSimpleArray, 138](#)
- [NewDate, 139](#)
- [NewDateTime, 139](#)
- [NewDecimal, 140](#)
- [NewObject, 141](#)
- [NewProxyObject, 141](#)
- [NewString, 142](#)
- [NewTime, 143](#)
- [NewUnboundedObjectArray, 143](#)
- [NewUnboundedSimpleArray, 144](#)
- [PopLocalFrame, 145](#)
- [ProcessPBMMessage, 146](#)
- [PushLocalFrame, 147](#)
- [ReleaseArrayInfo, 147](#)
- [ReleaseDateString, 148](#)
- [ReleaseDateTimeString, 149](#)
- [ReleaseDecimalString, 149](#)
- [ReleaseResultSetAccessor, 149](#)
- [ReleaseString, 150](#)
- [ReleaseTimeString, 151](#)
- [ReleaseValue, 151](#)
- [RemoveGlobalRef, 152](#)
- [RemoveLocalRef, 153](#)
- [RemoveProp, 153](#)
- [RestartRequested, 154](#)
- [Set<type>ArrayItem, 155](#)
- [Set<type>Field, 157](#)
- [Set<type>GlobalVar, 158](#)
- [Set<type>SharedVar, 159](#)
- [SetArrayItemToNull, 160](#)
- [SetArrayItemValue, 160](#)
- [SetBlob, 161](#)
- [SetDate, 161](#)
- [SetDateTime, 162](#)
- [SetDecimal, 163](#)
- [SetFieldToNull, 164](#)
- [SetGlobalVarToNull, 164](#)
- [SetMarshaler, 165](#)
- [SetProp, 166](#)
- [SetSharedVarToNull, 167](#)
- [SetString, 168](#)
- [SetTime, 169](#)
- [SetValue, 170](#)
- [SplitDate, 171](#)
- [SplitDateTime, 171](#)
- [SplitTime, 172](#)
- [ThrowException, 173](#)
- [TriggerEvent, 174](#)
- [UpdateField, 175](#)
- [IPB_Session interface, 41](#)
- [IPB_Value, 43](#)
 - [Get<type>, 176](#)
 - [GetClass, 177](#)
 - [GetType, 177](#)
 - [IsArray, 178](#)
 - [IsByRef, 179](#)
 - [IsEnum, 179](#)
 - [IsNull, 179](#)
 - [IsObject, 180](#)
 - [Set<type>, 181](#)
 - [SetToNull, 182](#)
- [IPB_Value interface, 40](#)
- [IPB_VM](#)
 - [CreateSession, 183](#)
 - [RunApplication, 184](#)
- [IsArray, 178](#)
- [IsArrayItemNull, 128](#)
- [IsAutoInstantiate, 128](#)
- [IsByRef, 179](#)
- [IsEnum, 179](#)
- [IsFieldArray, 129](#)
- [IsFieldNull, 129](#)
- [IsFieldObject, 130](#)
- [IsGlobalVarArray, 131](#)
- [IsGlobalVarNull, 132](#)
- [IsGlobalVarObject, 132](#)
- [IsNativeObject, 133](#)
- [IsNull \(IPB_Value\), 179](#)
- [IsNull \(PBArrayAccessor\), 199](#)
- [IsObject, 180](#)

- IsSharedVarArray, [134](#)
 - IsSharedVarNull, [135](#)
 - IsSharedVarObject, [135](#)
- J**
- Java classes, [37](#)
 - JNI, [7](#)
- L**
- local variable, [43](#)
- M**
- marshaller extensions
 - about, [32](#)
 - call Java class, [38](#)
 - develop, [32](#)
 - generate proxies for Java classes, [37](#)
- N**
- NewBlob, [136](#)
 - NewBoundedObjectArray, [137](#)
 - NewBoundedSimpleArray, [138](#)
 - NewDate, [139](#)
 - NewDateTime, [139](#)
 - NewDecimal, [140](#)
 - NewObject, [141](#)
 - NewProxyObject, [141](#)
 - NewString, [142](#)
 - NewTime, [143](#)
 - NewUnboundedObjectArray, [143](#)
 - NewUnboundedSimpleArray, [144](#)
- P**
- pbadd, [8](#)
 - PBArrayAccessor
 - GetAt, [198](#)
 - IsNull, [199](#)
 - SetAt, [199](#)
 - SetToNull, [200](#)
 - PBArrayInfo, [195](#)
 - PBBoundedArrayCreator
 - GetArray, [201](#)
 - SetAt, [202](#)
 - PBBoundedObjectArrayCreator
 - GetArray, [204](#)
 - SetAt, [204](#)
 - PBCallInfo, [195](#)
 - PBCallInfo structure, [39](#)
 - pbgroup_type, [60](#)
 - PBNI
 - about, [2](#)
 - class and interface, [63](#)
 - compare PBNI and JNI, [7](#)
 - datatype mappings, [59](#)
 - elements, [4](#)
 - embed PBVM in a C++ application, [4](#)
 - enumerated types, [60](#)
 - error return values, [61](#)
 - exchange data, [39](#)
 - header files, [63](#)
 - interfaces, [63](#)
 - methods, [63](#)
 - more possibilities, [56](#)
 - PBNI SDK, [6](#)
 - return values, [59](#)
 - structures, [63](#)
 - types, [59](#)
 - understand PowerBuilder extensions, [2](#)
 - PBNI project, [226](#)
 - PBObjectArrayAccessor
 - GetAt, [205](#)
 - SetAt, [206](#)
 - pbvt_type, [60](#)
 - pbsig170, [220](#)
 - PBUnboundedArrayCreator
 - GetArray, [207](#)
 - SetAt, [207](#)
 - PBUnboundedObjectArrayCreator
 - GetArray, [208](#)
 - SetAt, [208](#)
 - pbvalue_type, [60](#)
 - PBVM, [39](#)
 - pbx2pbd170, [222](#)
 - PBXRESULT, [61](#)
 - PBX_CreateNonVisualObject, [209](#)
 - PBX_CreateVisualObject, [211](#)
 - PBX_DrawItemStruct, [197](#)
 - PBX_DrawVisualObject, [212](#)
 - PBX_GetDescription, [213](#)
 - PBX_InvokeGlobalFunction, [215](#)
 - PBX_Notify, [217](#)
 - PB_DateData, [196](#)
 - PB_DateTimeData, [196](#)
 - PB_GetVM, [218](#)
 - PB_TimeData, [196](#)
 - PopLocalFrame, [145](#)
 - PowerBuilder extensions
 - add to a target, [18](#)

[build pbadd, 8](#)
[call PowerScript, 28](#)
[create, 12](#)
[create and use a visual extension, 20](#)
[create visual class instances, 22](#)
[event processing, 24](#)
[exception handling and debugging, 30](#)
[nonvisual extension example, 8](#)
[use, 19](#)
 PowerBuilder messages, [52](#)
 ProcessPBMessage, [146](#)
 proxies, [37](#)
 PushLocalFrame, [147](#)

R

[Release, 71](#)
[ReleaseArrayInfo, 147](#)
[ReleaseDateString, 148](#)
[ReleaseDateTimeString, 149](#)
[ReleaseDecimalString, 149](#)
[ReleaseResultSetAccessor, 149](#)
[ReleaseString, 150](#)
[ReleaseTimeString, 151](#)
[ReleaseValue, 151](#)
[RemoveGlobalRef, 152](#)
[RemoveLocalRef, 153](#)
[RemoveProp, 153](#)
[RestartRequested, 154](#)
[RunApplication, 184](#)

S

[session, 45](#)
[Set<type>, 181](#)
[Set<type>ArrayItem, 155](#)
[Set<type>Field, 157](#)
[Set<type>GlobalVar, 158](#)
[Set<type>SharedVar, 159](#)
[SetArrayItemToNull, 160](#)
[SetArrayItemValue, 160](#)
[SetAt \(PBArrayAccessor\), 199](#)
[SetAt \(PBBoundedArrayCreator\), 202](#)
[SetAt \(PBBoundedObjectArrayCreator\), 204](#)
[SetAt \(PBOBJECTArrayAccessor\), 206](#)
[SetAt \(PBUnboundedArrayCreator\), 207](#)
[SetAt \(PBUnboundedObjectArrayCreator\), 208](#)
[SetBlob, 161](#)
[SetData, 71](#)
[SetDate, 161](#)

[SetDateTime, 162](#)
[SetDecimal, 163](#)
[SetFieldToNull, 164](#)
[SetGlobalVarToNull, 164](#)
[SetMarshaler, 165](#)
[SetNull, 72](#)
[SetProp, 166](#)
[SetSharedVarToNull, 167](#)
[SetString, 168](#)
[SetTime, 169](#)
[SetToNull \(IPB_Value\), 182](#)
[SetToNull \(PBArrayAccessor\), 200](#)
[SetValue, 170](#)
[SplitDate, 171](#)
[SplitDateTime, 171](#)
[SplitTime, 172](#)

T

[ThrowException, 173](#)
[TriggerEvent, 174](#)

U

[UpdateField, 175](#)

V

[variables, 45](#)
[visual class instances, 22](#)