

Connecting to Your Database

Appeon InfoMaker® 2019 R2
FOR WINDOWS

DOCUMENT ID: DC37791-01-1900-01

LAST REVISED: March 25, 2020

Copyright © 2019 Appeon. All rights reserved.

This publication pertains to Appeon software and to any subsequent release until otherwise indicated in new editions or technical notes. Information in this document is subject to change without notice. The software described herein is furnished under a license agreement, and it may be used or copied only in accordance with the terms of that agreement.

Upgrades are provided only at regularly scheduled software release dates. No part of this publication may be reproduced, transmitted, or translated in any form or by any means, electronic, mechanical, manual, optical, or otherwise, without the prior written permission of Appeon Inc.

Appeon and other Appeon products and services mentioned herein as well as their respective logos are trademarks or registered trademarks of Appeon Inc.

SAP and other SAP products and services mentioned herein as well as their respective logos are trademarks or registered trademarks of SAP and SAP affiliate company.

Java and all Java-based marks are trademarks or registered trademarks of Oracle and/or its affiliates in the U.S. and other countries.

Unicode and the Unicode Logo are registered trademarks of Unicode, Inc.

All other company and product names mentioned may be trademarks of the respective companies with which they are associated.

Use, duplication, or disclosure by the government is subject to the restrictions set forth in subparagraph (c)(1)(ii) of DFARS 52.227-7013 for the DOD and as set forth in FAR 52.227-19(a)-(d) for civilian agencies.

Appeon Inc., 1/F, Shell Industrial Building, 12 Lee Chung Street, Chai Wan District, Hong Kong

Contents

I Introduction to Database Connections	1
1 Understanding Data Connections	2
1.1 How to find the information you need	2
1.2 Accessing data in InfoMaker	3
1.3 Accessing the Demo Database	4
1.4 Using database profiles	4
1.4.1 About creating database profiles	5
1.4.2 Creating a database profile	8
1.5 What to do next	9
II Working with Standard Database Interfaces	10
2 Using the ODBC Interface	11
2.1 Using the ODBC interface	11
2.1.1 What is ODBC?	11
2.1.2 Using ODBC in InfoMaker	12
2.1.3 Components of an ODBC connection	12
2.1.4 Types of ODBC drivers	14
2.1.5 Ensuring the proper ODBC driver conformance levels	16
2.1.5.1 What are ODBC conformance levels?	16
2.1.6 Obtaining ODBC drivers	18
2.1.7 Getting help with ODBC drivers	18
2.2 Preparing ODBC data sources	18
2.3 Defining ODBC data sources	19
2.3.1 How InfoMaker accesses the data source	19
2.3.1.1 PBODB190 initialization file	19
2.3.1.2 ODBCINST registry entries	20
2.3.1.3 ODBC registry entries	20
2.3.1.4 Database profiles registry entry	21
2.3.2 Defining multiple data sources for the same data	22
2.3.3 Displaying Help for ODBC drivers	22
2.3.3.1 Help for any ODBC driver	22
2.3.4 Selecting an ODBC translator	23
2.4 Defining the ODBC interface	23
2.5 SAP SQL Anywhere	23
2.5.1 Supported versions for SQL Anywhere	24
2.5.2 Basic software components for SQL Anywhere	24
2.5.3 Preparing to use the SQL Anywhere data source	25
2.5.4 Defining the SQL Anywhere data source	26
2.5.5 Support for Transact-SQL special timestamp columns	28
2.5.6 What to do next	29
2.6 PostgreSQL	29
3 Using the JDBC Interface	31
3.1 About the JDBC interface	31
3.1.1 What is JDBC?	31
3.1.2 Components of a JDBC connection	32
3.1.3 JDBC registry entries	33
3.1.4 Supported versions for JDBC	34

3.1.5 Supported JDBC datatypes	34
3.2 Preparing to use the JDBC interface	34
3.3 Defining the JDBC interface	35
4 Using the OLE DB interface	37
4.1 About the OLE DB interface	37
4.1.1 What is OLE DB?	37
4.1.2 Components of an OLE DB connection	39
4.1.3 Obtaining OLE DB data providers	40
4.1.4 Supported versions for OLE DB	40
4.2 Preparing to use the OLE DB interface	41
4.3 Defining the OLE DB interface	42
5 Using the ADO.NET interface	44
5.1 About ADO.NET	44
5.2 About the InfoMaker ADO.NET database interface	45
5.2.1 Components of an ADO.NET connection	45
5.2.2 OLE DB data providers	46
5.3 Preparing to use the ADO.NET interface	47
5.4 Defining the ADO.NET interface	48
III Working with Native Database Interfaces	50
6 Using Native Database Interfaces	51
6.1 About native database interfaces	51
6.1.1 What is a native database interface?	51
6.1.2 Components of a database interface connection	51
6.1.3 Using a native database interface	52
6.2 Informix	53
6.2.1 Supported versions for Informix	53
6.2.2 Supported Informix datatypes	54
6.2.2.1 Informix DateTime datatype	54
6.2.2.2 Informix Time datatype	55
6.2.2.3 Informix Interval datatype	55
6.2.3 Basic software components for Informix	55
6.2.4 Preparing to use the Informix database	56
6.2.5 Defining the Informix database interface	57
6.2.5.1 Specifying the server name	58
6.2.6 What to do next	58
6.3 Microsoft SQL Server	58
6.3.1 Supported versions for SQL Server	58
6.3.2 Supported SQL Server datatypes	59
6.3.3 Basic software components for Microsoft SQL Server	59
6.3.4 Preparing to use the SQL Server database	60
6.3.5 Defining the SQL Server database interface	62
6.3.6 Migrating from the MSS or OLE DB database interfaces	62
6.3.7 SQL Server 2008 features	65
6.3.7.1 New database parameters	65
6.3.7.2 Support for new datatypes in SQL Server 2008	66
6.3.7.3 T-SQL enhancements	69
6.3.7.4 Unsupported SQL Server 2008 features	71
6.3.8 Notes on using the SNC interface	71

6.4 Oracle	72
6.4.1 Supported versions for Oracle	72
6.4.2 Supported Oracle datatypes	72
6.4.3 Basic software components for Oracle	73
6.4.4 Preparing to use the Oracle database	74
6.4.4.1 What to do next	76
6.4.5 Defining the Oracle database interface	76
6.4.5.1 Specifying the Oracle server connect descriptor	76
6.4.6 Using Oracle stored procedures as a data source	77
6.4.6.1 What is an Oracle stored procedure?	77
6.4.6.2 What you can do with Oracle stored procedures	77
6.4.6.3 Using Oracle stored procedures with result sets	77
6.4.6.4 Using a large-object output parameter	80
6.4.7 Using Oracle user-defined types	80
6.4.8 What to do next	82
6.5 Adaptive Server Enterprise	82
6.5.1 Supported versions for Adaptive Server	82
6.5.2 Supported Adaptive Server datatypes	82
6.5.3 Basic software components for Adaptive Server	83
6.5.4 Preparing to use the Adaptive Server database	84
6.5.4.1 What to do next	86
6.5.5 Defining the Adaptive Server database interface	86
6.5.6 Using Open Client security services	87
6.5.6.1 What are Open Client security services?	87
6.5.6.2 Requirements for using Open Client security services	87
6.5.6.3 Security services DBParm parameters	88
6.5.7 Using Open Client directory services	89
6.5.7.1 What are Open Client directory services?	89
6.5.7.2 Requirements for using Open Client directory services	89
6.5.7.3 Specifying the server name with Open Client directory services	90
6.5.7.4 Directory services DBParm parameters	91
6.5.8 Using PRINT statements in Adaptive Server stored procedures	91
6.5.9 Creating a DataWindow based on a heterogeneous cross- database join	91
6.5.10 What to do next	92
6.6 Installing InfoMaker stored procedures in Adaptive Server databases	92
6.6.1 What are the InfoMaker stored procedure scripts?	92
6.6.1.1 PBSYC.SQL script	93
6.6.1.2 PBSYC2.SQL script	94
6.6.2 How to run the scripts	95
6.6.2.1 Using ISQL to run the stored procedure scripts	95
6.6.2.2 Using SQL Advantage to run the stored procedure scripts	96

6.7	DirectConnect	97
6.7.1	Using the DirectConnect interface	97
6.7.1.1	Connecting through the DirectConnect middleware product	97
6.7.1.2	Connecting through the Open ServerConnect middleware product	98
6.7.1.3	Selecting the type of connection	98
6.7.2	Basic software components for the DirectConnect interface	98
6.7.3	Supported versions for the DirectConnect interface	100
6.7.4	Supported DirectConnect interface datatypes	101
6.7.5	Preparing to use the database with DirectConnect	101
6.7.6	Defining the DirectConnect interface	103
6.8	Creating the extended attribute system tables in DB2 databases	104
6.8.1	Creating the extended attribute system tables	104
6.8.2	Using the DB2SYSPB.SQL script	104
IV	Working with Database Connections	106
7	Managing Database Connections	107
7.1	About database connections	107
7.1.1	When database connections occur	107
7.1.2	Using database profiles	109
7.2	Connecting to a database	109
7.2.1	Selecting a database profile	110
7.2.2	What happens when you connect	111
7.2.3	Specifying passwords in database profiles	111
7.3	Maintaining database profiles	112
7.4	Sharing database profiles	112
7.4.1	About shared database profiles	112
7.4.2	Setting up shared database profiles	113
7.4.3	Using shared database profiles to connect	114
7.4.4	Making local changes to shared database profiles	115
7.4.5	Maintaining shared database profiles	116
7.5	Importing and exporting database profiles	116
7.6	About the InfoMaker extended attribute system tables	117
7.6.1	Logging on to your database for the first time	118
7.6.2	Displaying the InfoMaker extended attribute system tables	118
7.6.3	Contents of the extended attribute system tables	120
7.6.4	Controlling system table access	121
7.6.4.1	Setting Use Extended Attributes or Read Only to control access	121
7.6.4.2	Granting permissions on system tables to control access	123
8	Setting Additional Connection Parameters	124
8.1	Basic steps for setting connection parameters	124
8.2	About the Database Profile Setup dialog box	125
8.3	Setting database parameters	125
8.3.1	Setting database parameters in the development environment	125

8.4	Setting database preferences	125
8.4.1	Setting database preferences in the development environment	126
8.4.1.1	Setting AutoCommit and Lock in the database profile	126
8.4.1.2	Setting preferences in the Database Preferences property sheet	127
9	Troubleshooting Your Connection	131
9.1	Overview of troubleshooting tools	131
9.2	Using the Database Trace tool	131
9.2.1	About the Database Trace tool	131
9.2.1.1	How you can use the Database Trace tool	131
9.2.1.2	Location of the Database Trace log	132
9.2.1.3	Contents of the Database Trace log	132
9.2.1.4	Format of the Database Trace log	133
9.2.2	Starting the Database Trace tool	133
9.2.3	Stopping the Database Trace tool	134
9.2.4	Specifying a nondefault Database Trace log	134
9.2.5	Using the Database Trace log	135
9.2.5.1	Viewing the Database Trace log	135
9.2.5.2	Annotating the Database Trace log	136
9.2.5.3	Deleting or clearing the Database Trace log	136
9.2.6	Sample Database Trace output	136
9.3	Using the ODBC Driver Manager Trace	138
9.3.1	About ODBC Driver Manager Trace	138
9.3.2	Starting ODBC Driver Manager Trace	139
9.3.2.1	Starting ODBC Driver Manager Trace	139
9.3.3	Stopping ODBC Driver Manager Trace	140
9.3.3.1	Stopping ODBC Driver Manager Trace	140
9.3.4	Viewing the ODBC Driver Manager Trace log	140
9.3.5	Sample ODBC Driver Manager Trace output	141
9.4	Using the JDBC Driver Manager Trace	143
9.4.1	About JDBC Driver Manager Trace	143
9.4.2	Starting JDBC Driver Manager Trace	143
9.4.2.1	Starting JDBC Driver Manager Trace	144
9.4.3	Stopping JDBC Driver Manager Trace	145
9.4.3.1	Stopping JDBC Driver Manager Trace	145
9.4.4	Viewing the JDBC Driver Manager Trace log	146
V	Appendix	147
A	Adding Functions to the PBODB190 Initialization File	148
A.1	About the PBODB190 initialization file	148
A.1.1	Adding functions to PBODB190.INI	148
A.1.1.1	Adding functions to an existing section in the file	149
A.1.1.2	Adding functions to a new section in the file	151
	Index	154

Part I. Introduction to Database Connections

This part introduces data connections in InfoMaker. It gives an overview of the concepts and procedures for connecting to a database in the InfoMaker development environment.

1 Understanding Data Connections

About this chapter

This chapter gives an overview of the concepts and procedures for connecting to a database in the InfoMaker development environment.

1.1 How to find the information you need

What's in this book

This book describes how to connect to your database in the InfoMaker development environment.

Basic connection procedure

The following table gives an overview of the connection procedure and indicates where you can find detailed information about each step.

Table 1.1: Basic connection procedure

Step	Action	Details	See
1	(Optional) Get an introduction to database connections in InfoMaker.	If necessary, learn more about how InfoMaker connects to a database in the development environment.	Chapter 1 (this chapter)
2	Prepare to use the data source or database before connecting to it for the first time in InfoMaker.	Outside InfoMaker, install the required network, database server, and database client software and verify that you can connect to the database.	For ODBC data sources: Using the ODBC Interface For JDBC data sources: Using the JDBC Interface For OLE DB data sources: Using the OLE DB interface For ADO.NET data sources: Using the ADO.NET interface For native database interfaces: Using Native Database Interfaces
3	Install the ODBC driver, OLE DB data provider, ADO.NET data provider, or native database interface.	Install the driver, database provider, or native database interface required to access your data.	For a list of what is supported on your platform: "Supported Database Interfaces" in online Help
4	Define the data source (ODBC connections and some OLE DB drivers).	Create the required configuration for a data source accessed through ODBC.	For ODBC data sources: Using the ODBC Interface

Step	Action	Details	See
5	Define the database interface.	Create the database profile.	For ODBC data sources: Using the ODBC Interface For JDBC data sources: Using the JDBC Interface For OLE DB data sources: Using the OLE DB interface For ADO.NET data sources: Using the ADO.NET interface For native database interfaces: Using Native Database Interfaces
6	Connect to the data source or database.	Access the data in InfoMaker.	Managing Database Connections
7	(Optional) Set additional connection parameters.	If necessary, set DBParm parameters and database preferences to fine-tune your database connection and take advantage of DBMS-specific features that your interface supports.	For procedures: Setting Additional Connection Parameters For DBParm descriptions: online Help For database preference descriptions: online Help
8	(Optional) Troubleshoot the data connection.	If necessary, use the trace tools to troubleshoot problems with your connection.	Troubleshooting Your Connection

1.2 Accessing data in InfoMaker

There are several ways to access data in the InfoMaker development environment:

- Through one of the standard database interfaces such as ODBC, JDBC, OLE DB, or ADO.NET
- Through one of the native database interfaces

Standard database interfaces

A standard database interface communicates with a database through a standard-compliant driver (in the case of ODBC and JDBC) or data provider (in the case of OLE DB and ADO.NET). The standard-compliant driver or data provider translates the abstract function calls defined by the standard's API into calls that are understood by a specific database. To use a standard interface, you need to install the standard's API and a suitable driver or data

provider. Then, install the standard database interface you want to use to access your DBMS by selecting the interface in the InfoMaker Setup program.

InfoMaker currently supports the following standard interfaces:

- Open Database Connectivity (ODBC)
- Java Database Connectivity (JDBC)
- Microsoft's Universal Data Access Component OLE DB
- Microsoft's ADO.NET

Native database interfaces

A native database interface communicates with a database through a direct connection. It communicates to a database using that database's native API.

To access data through one of the native database interfaces, you must first install the appropriate database software on the server and client workstations at your site. Then, install the native database interface that accesses your DBMS by selecting the interface in the InfoMaker Setup program.

For example, if you have the appropriate SAP Adaptive Server Enterprise server and client software installed, you can access the database by installing the Adaptive Server Enterprise database interface.

InfoMaker with other SAP products

If your version of InfoMaker was provided with another SAP product, see the Help for that product for information about database connectivity features.

1.3 Accessing the Demo Database

InfoMaker includes a standalone SQL Anywhere database called the PB Demo Database. The database is installed automatically. You access tables in the Demo Database when you use the InfoMaker tutorial.

A SQL Anywhere database is considered an ODBC data source, because you access it with the SQL Anywhere ODBC driver.

1.4 Using database profiles

What is a database profile?

A database profile is a named set of parameters stored in your system registry that defines a connection to a particular database in the InfoMaker development environment. You must create a database profile for each data connection.

What you can do

Using database profiles is the easiest way to manage data connections in the InfoMaker development environment. For example, you can:

- Select a database profile to connect to or switch between databases

- Edit a database profile to customize a connection
- Delete a database profile if you no longer need to access that data
- Import and export database profiles to quickly share connection parameters

For more information

For instructions on using database profiles, see [Managing Database Connections](#)

1.4.1 About creating database profiles

You work with two dialog boxes when you create a database profile in InfoMaker: the Database Profiles dialog box and the interface-specific Database Profile Setup dialog box.

Using the Database painter to create database profiles

The Database painter is an optional InfoMaker painter. If the Database painter is installed, you can also create database profiles from the Database painter's Objects view. However, opening the Database painter to define profiles and/or connect to a database uses more system resources than using the Database Profiles dialog box.

Database Profiles dialog box

The Database Profiles dialog box uses an easy-to-navigate tree control format to display your installed database interfaces and defined database profiles. You can create, edit, and delete database profiles from this dialog box.

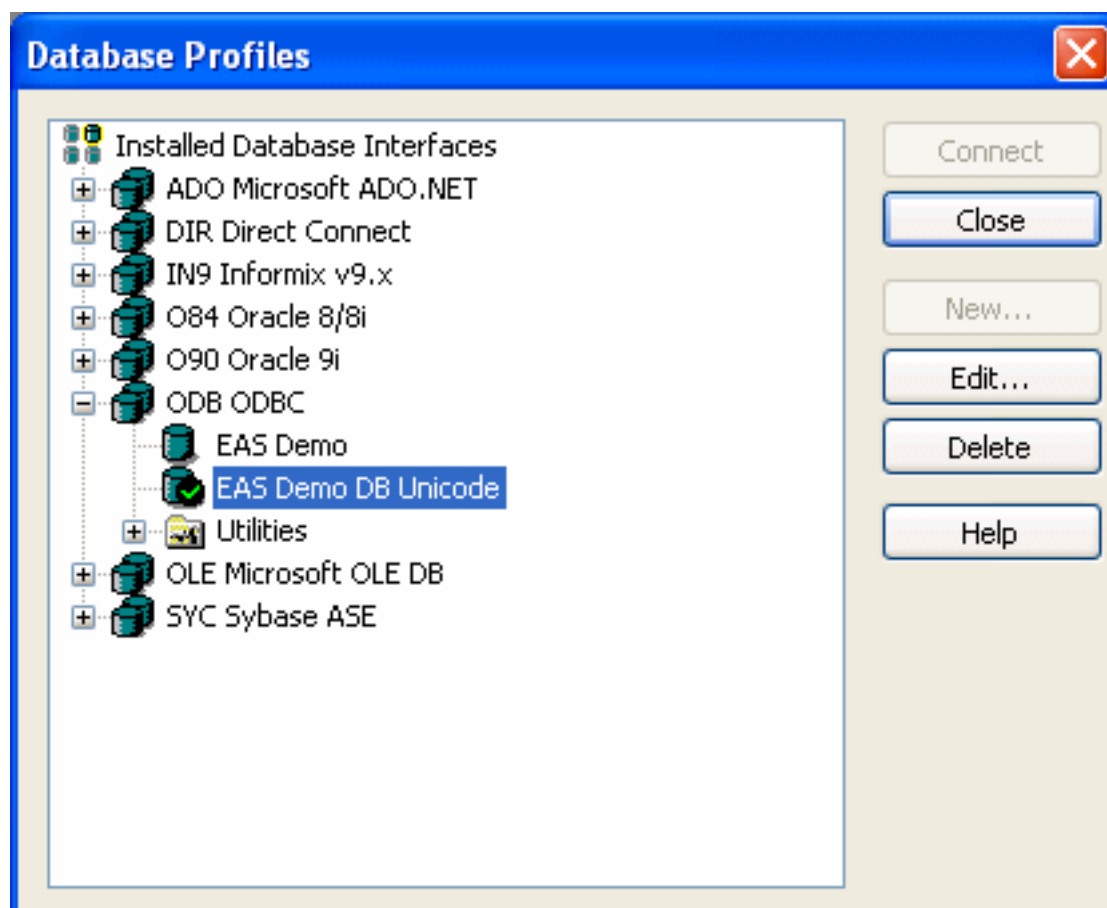

When you run the InfoMaker Setup program, it updates the Vendors list in the PowerBuilder section in the HKEY_LOCAL_MACHINE registry key with the interfaces you install. The Database Profiles dialog box displays the same interfaces that appear in the Vendors list.

Where the Vendors list is stored

The Sybase\PowerBuilder\18.0\Vendors key in HKEY_LOCAL_MACHINE \SOFTWARE is used for InfoMaker as well as PowerBuilder.

For detailed instructions on using the Database Profiles dialog box to connect to a database and manage your profiles, see [Managing Database Connections](#)

Database Profile Setup dialog box

Each database interface has its own Database Profile Setup dialog box where you can set interface-specific connection parameters. For example, if you install the O90 interface and then select it and click New in the Database Profiles dialog box, the Database Profile Setup - Oracle 9i dialog box displays, containing settings for those connection options that apply to this interface.

Preview tab unavailable in InfoMaker

PowerScript connection syntax does not apply to InfoMaker. Therefore, the Database Profile Setup dialog box in InfoMaker does not include a Preview tab for copying PowerScript connection syntax into a script.

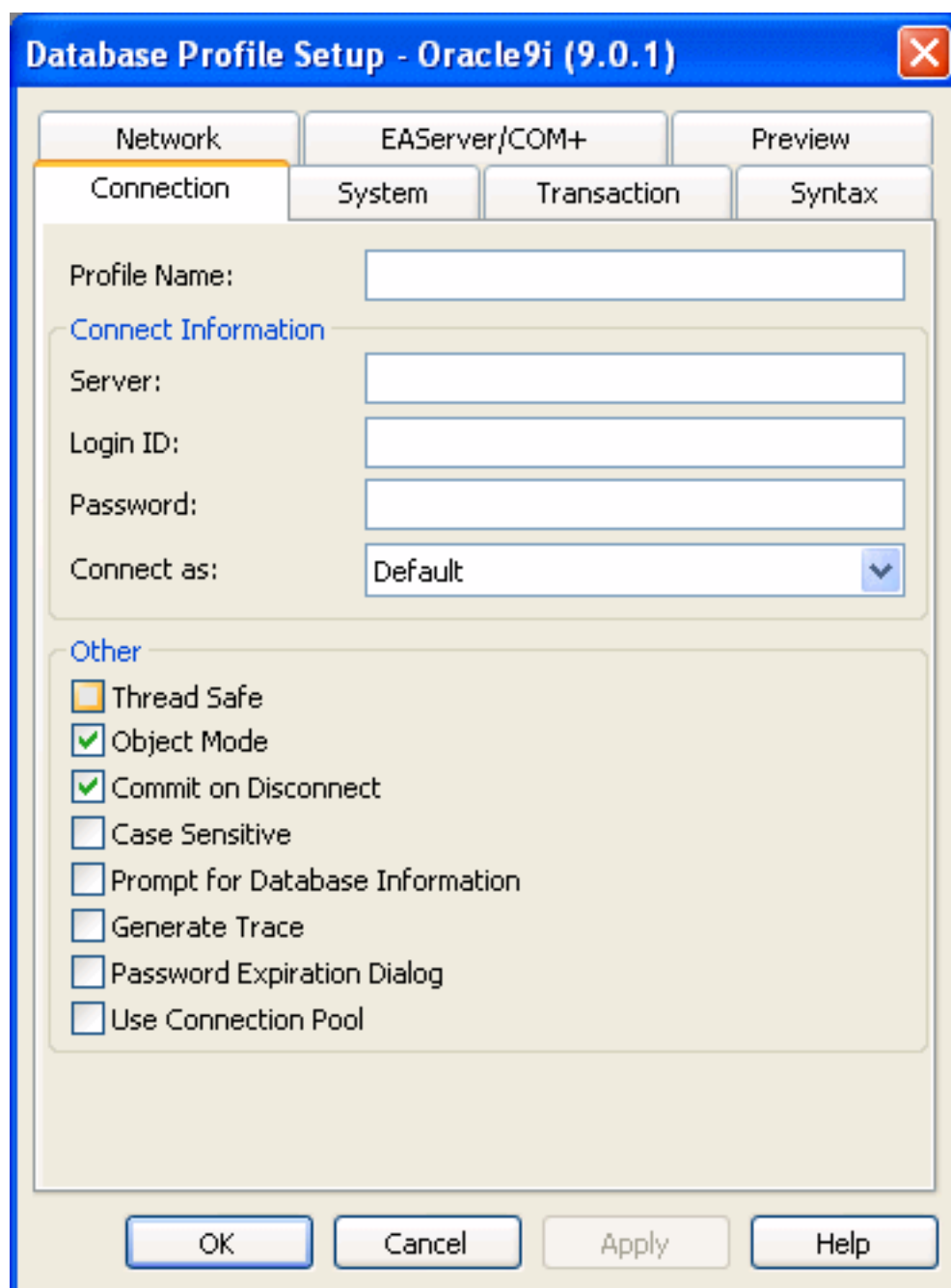

The Database Profile Setup dialog box groups similar connection parameters on the same tab page and lets you easily set their values by using check boxes, drop-down lists, and text boxes. Basic (required) connection parameters are on the Connection tab page, and additional connection options (DBParm parameters and SQLCA properties) are on the other tab pages.

Supplying sufficient information in the Database Profile Setup dialog box

For some database interfaces, you might not need to supply values for all boxes in the Database Profile Setup dialog box. If you supply the profile name and click OK, InfoMaker displays a series of dialog boxes to prompt you for additional information when you connect to the database.

This information can include:

User ID or login ID

Password or login password

Database name

Server name

For some databases, supplying only the profile name does not give InfoMaker enough information to prompt you for additional connection values. For these interfaces, you must supply values for all applicable boxes in the Database Profile Setup dialog box.

For information about the values you should supply for your connection, click Help in the Database Profile Setup dialog box for your interface.

1.4.2 Creating a database profile

To create a new database profile for a database interface, you must complete the Database Profile Setup dialog box for the interface you are using to access the database.

When using InfoMaker

The Database Profile Setup dialog box in InfoMaker does not include the Preview tab.

To create a database profile for a database interface:

1. Click the Database Profile button in the PowerBar.

The Database Profiles dialog box displays, listing your installed database interfaces. To see a list of database profiles defined for a particular interface, click the plus sign to the left of the interface name or double-click the interface name to expand the list.

2. Highlight an interface name and click New.

The Database Profile Setup dialog box for the selected interface displays. For example, if you select the SYC interface, the Database Profile Setup - Adaptive Server Enterprise dialog box displays.

Client software and interface must be installed

To display the Database Profile Setup dialog box for your interface, the required client software and native database interface must be properly installed and configured. For specific instructions for your database interface, see the chapter on using the interface.

3. On the Connection tab page, type the profile name and supply values for any other basic parameters your interface requires to connect.

For information about the basic connection parameters for your interface and the values you should supply, click Help.

About the DBMS identifier

You do not need to specify the DBMS identifier in a database profile. When you create a new profile for any installed database interface, InfoMaker generates the correct DBMS connection syntax for you.

4. (Optional) On the other tab pages, supply values for any additional connection options (DBParm parameters and SQLCA properties) to take advantage of DBMS-specific features that your interface supports.

For information about the additional connection parameters for your interface and the values you should supply, click Help.

5. Click OK to save your changes and close the Database Profile Setup dialog box. (To save your changes on a particular tab page without closing the dialog box, click Apply.)

The Database Profiles dialog box displays, with the new profile name highlighted under the appropriate interface. The database profile values are saved in the system registry.

1.5 What to do next

For instructions on preparing to use and then defining an ODBC data source, see [Using the ODBC Interface](#)

For instructions on preparing to use and then defining a JDBC database interface, see [Using the JDBC Interface](#)

For instructions on preparing to use and then defining an OLE DB data provider, see [Using the OLE DB interface](#)

For instructions on preparing to use and then defining an ADO.NET data provider, see [Using the ADO.NET interface](#)

For instructions on preparing to use and then defining a native database interface, see [Using Native Database Interfaces](#)

Part II. Working with Standard Database Interfaces

This part describes how to set up and define database connections accessed through one of the standard database interfaces.

2 Using the ODBC Interface

About this chapter

This chapter gives an introduction to the ODBC interface and then describes how to prepare to use the data source, how to define the data source, and how to define the ODBC database profile. It also describes how to use the SQL Anywhere ODBC driver.

For more information

This chapter gives general information about preparing to use and defining each ODBC data source. For more detailed information:

- Use the online Help provided by the driver vendor, as described in [Displaying Help for ODBC drivers](#). This Help provides important details about using the data source.
- Check to see if there is a technical document that describes how to connect to your ODBC data source. Any updated information about connectivity issues is available from the the Apeon Support Web site at <https://support.appeon.com/>.

2.1 Using the ODBC interface

You can access a wide variety of ODBC data sources in InfoMaker. This section describes what you need to know to use ODBC connections to access your data in InfoMaker.

ODBC drivers and data sources

For a complete list of the ODBC drivers supplied with InfoMaker and the data sources they access, see "Database Interfaces" in online Help.

2.1.1 What is ODBC?

The ODBC API

Open Database Connectivity (ODBC) is a standard application programming interface (API) developed by Microsoft. It allows a single application to access a variety of data sources for which ODBC-compliant drivers exist. The application uses Structured Query Language (SQL) as the standard data access language.

The ODBC API defines the following:

- A library of ODBC function calls that connect to the data source, execute SQL statements, and retrieve results
- A standard way to connect and log in to a DBMS
- SQL syntax based on the X/Open and SQL Access Group (SAG) CAE specification (1992)
- A standard representation for datatypes
- A standard set of error codes

Accessing ODBC data sources

Applications that provide an ODBC interface, like InfoMaker, can access data sources for which an ODBC driver exists. An ODBC data source driver is a dynamic link library (DLL) that implements ODBC function calls. The application invokes the ODBC driver to access a particular data source.

Accessing Unicode data

Using the ODBC interface, InfoMaker can connect, save, and retrieve data in both ANSI/DBCS and Unicode databases but does not convert data between Unicode and ANSI/DBCS. When character data or command text is sent to the database, InfoMaker sends a Unicode string. The driver must guarantee that the data is saved as Unicode data correctly. When InfoMaker retrieves character data, it assumes the data is Unicode.

A Unicode database is a database whose character set is set to a Unicode format, such as UTF-8, UTF-16, UCS-2, or UCS-4. All data must be in Unicode format, and any data saved to the database must be converted to Unicode data implicitly or explicitly.

A database that uses ANSI (or DBCS) as its character set might use special datatypes to store Unicode data. These datatypes are NCHAR, NVARCHAR, and NVARCHAR2. Columns with this datatype can store only Unicode data. Any data saved into such a column must be converted to Unicode explicitly. This conversion must be handled by the database server or client.

2.1.2 Using ODBC in InfoMaker

What you can do

The following ODBC connectivity features are available in InfoMaker:

- Connect to an SQL Anywhere standalone database (including the Demo Database) using the SQL Anywhere ODBC driver and the ODBC interface.
- Create and delete local SQL Anywhere databases.
For instructions, see the User's Guide.
- Use SAP-supplied DataDirect ODBC drivers to access your data.
For a list of the ODBC drivers supplied, see "Database Interfaces" in online Help.
- Use Level 1 or later ODBC-compliant drivers obtained from vendors other than SAP to access your data.
See [Obtaining ODBC drivers](#).
- Use Microsoft's ODBC Data Source Administrator to define ODBC data sources.
See [Defining ODBC data sources](#).

2.1.3 Components of an ODBC connection

How an ODBC connection is made

When you access an ODBC data source in InfoMaker, your connection goes through several layers before reaching the data source. It is important to understand that each layer represents

a separate component of the connection, and that each component might come from a different vendor.

Because ODBC is a standard API, InfoMaker uses the same interface to access every ODBC data source. As long as a driver is ODBC compliant, InfoMaker can access it through the ODBC interface to the ODBC Driver Manager. The development environment and the ODBC interface work together as the application component.

The following figure shows the general components of an ODBC connection.

Figure: Components of an ODBC connection

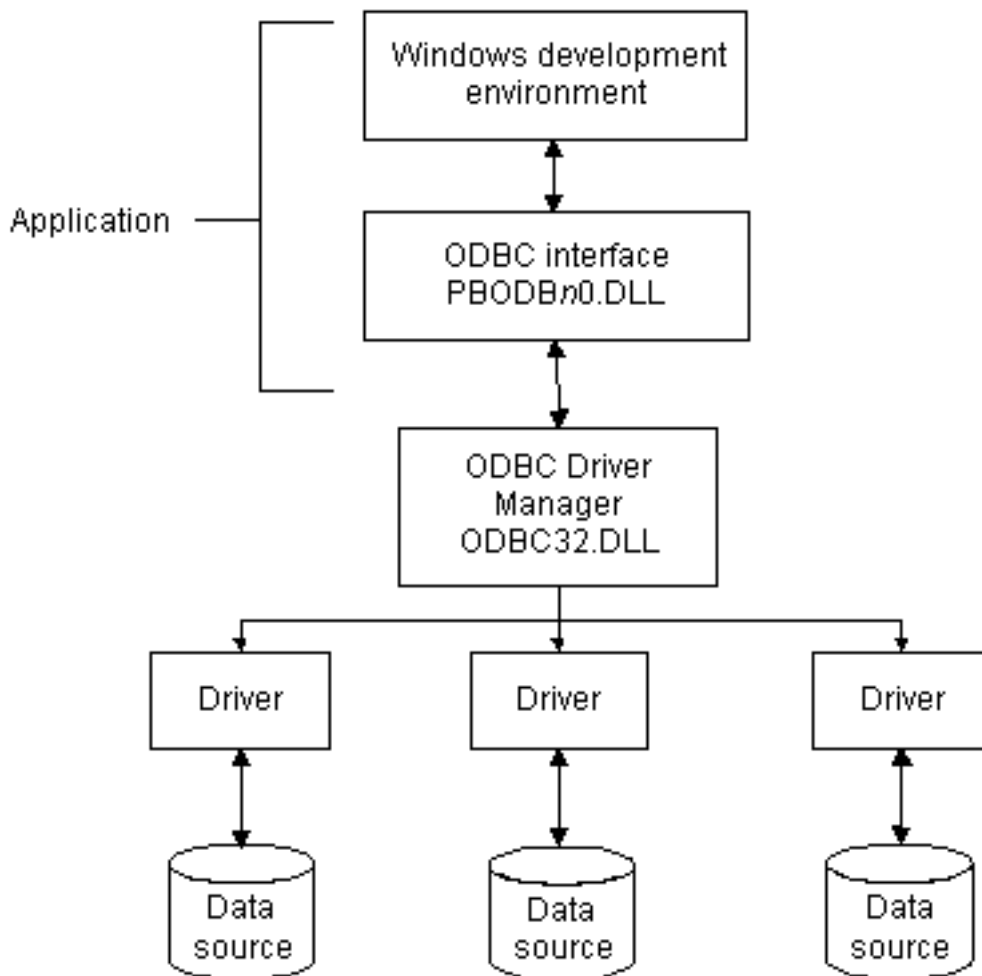

Component descriptions

The following table gives the provider and a brief description of each ODBC component shown in the diagram:

Table 2.1: Provider and function of ODBC connection components

Component	Provider	What it does
Application	SAP	Calls ODBC functions to submit SQL statements, catalog requests, and retrieve results from a data source.

Component	Provider	What it does
		InfoMaker uses the same ODBC interface to access all ODBC data sources.
ODBC Driver Manager	Microsoft	Installs, loads, and unloads drivers for an application.
Driver	Driver vendor	Processes ODBC function calls, submits SQL requests to a particular data source, and returns results to an application. If necessary, translates an application's request so that it conforms to the SQL syntax supported by the back-end database. See Types of ODBC drivers .
Data source	DBMS or database vendor	Stores and manages data for an application. Consists of the data to be accessed and its associated DBMS, operating system, and (if present) network software that accesses the DBMS.

2.1.4 Types of ODBC drivers

When InfoMaker is connected to an ODBC data source, you might see messages from the ODBC driver that include the words single-tier or multiple-tier. These terms refer to the two types of drivers defined by the ODBC standard.

Single-tier driver

A single-tier ODBC driver processes both ODBC functions and SQL statements. In other words, a single-tier driver includes the data access software required to manage the data source file and catalog tables. An example of a single-tier ODBC driver is one that accesses Xbase files, such as the DataDirect dBASE ODBC driver.

Figure: Single-tier ODBC driver

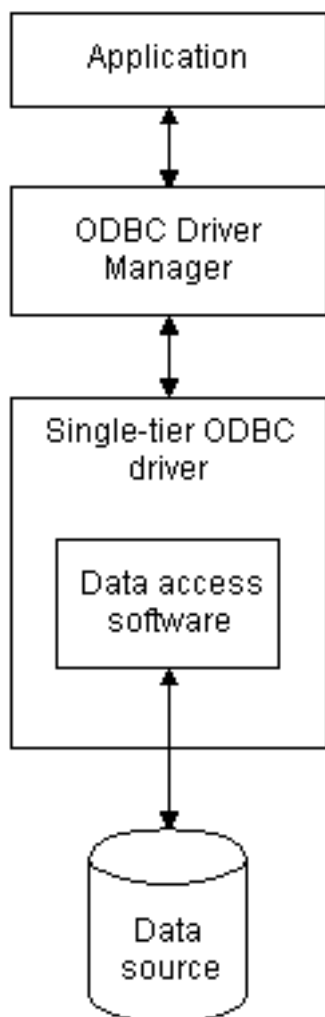

Multiple-tier driver

A multiple-tier ODBC driver processes ODBC functions, but sends SQL statements to the database engine for processing. Unlike the single-tier driver, a multiple-tier driver does not include the data access software required to manage the data directly.

An example of a multiple-tier ODBC driver is the SQL Anywhere driver.

Figure: Multi-tier ODBC driver

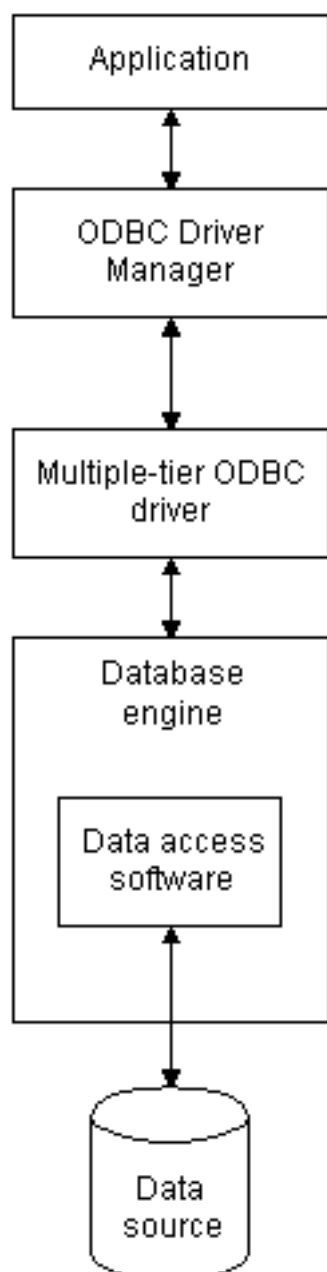

2.1.5 Ensuring the proper ODBC driver conformance levels

You can access data in InfoMaker with ODBC drivers obtained from vendors other than SAP, such as DBMS vendors.

An ODBC driver obtained from another vendor must meet certain conformance requirements to ensure that it works properly with InfoMaker. This section describes how to make sure your driver meets these requirements.

2.1.5.1 What are ODBC conformance levels?

InfoMaker can access many data sources for which ODBC-compliant drivers exist. However, ODBC drivers manufactured by different vendors might vary widely in the functions they provide.

To ensure a standard level of compliance with the ODBC interface, and to provide a means by which application vendors can determine if a specific driver provides the functions they need, ODBC defines conformance levels for drivers in two areas:

- **API**
Deals with supported ODBC function calls
- **SQL grammar**
Deals with supported SQL statements and SQL datatypes

API conformance levels

ODBC defines three API conformance levels, in order of increasing functionality:

- **Core**
A set of core API functions that corresponds to the functions in the ISO Call Level Interface (CLI) and X/Open CLI specification
- **Level 1**
Includes all Core API functions and several extended functions usually available in an OLTP relational DBMS
- **Level 2**
Includes all Core and Level 1 API functions and additional extended functions

To ensure the proper ODBC driver API conformance level:

- SAP recommends that the ODBC drivers you use with InfoMaker meet Level 1 or higher API conformance requirements. However, InfoMaker might also work with drivers that meet Core level API conformance requirements.

SQL conformance levels

ODBC defines three SQL grammar conformance levels, in order of increasing functionality:

- **Minimum**
A set of SQL statements and datatypes that meets a basic level of ODBC conformance
- **Core**
Includes all Minimum SQL grammar and additional statements and datatypes that roughly correspond to the X/Open and SAG CAE specification (1992)
- **Extended**
Includes all Minimum and Core SQL grammar and an extended set of statements and datatypes that support common DBMS extensions to SQL

To ensure the proper ODBC driver SQL conformance level:

- SAP recommends that the ODBC drivers you use with InfoMaker meet Core or higher SQL conformance requirements. However, InfoMaker might also work with drivers that meet Minimum level SQL conformance requirements.

2.1.6 Obtaining ODBC drivers

Two sources

There are two ways that you can obtain ODBC drivers for use with InfoMaker:

- From SAP (recommended)

Install one or more of the ODBC drivers shipped with InfoMaker. You can do this when you first install InfoMaker, or later.

- From another vendor

InfoMaker lets you access data with any Level 1 or higher ODBC-compliant drivers obtained from a vendor other than SAP. In most cases, these drivers will work with InfoMaker.

2.1.7 Getting help with ODBC drivers

To ensure that you have up-to-date and accurate information about using your ODBC driver with InfoMaker, get help as needed by doing one or more of the following:

Table 2.2:

To get help on	Do this
Using the ODBC Data Source Administrator	Click the Help button on each tab.
Completing the ODBC setup dialog box for your driver	Click the Help button (if present) in the ODBC setup dialog box for your driver.
Using SQL Anywhere	See the SQL Anywhere documentation.
Using an ODBC driver obtained from a vendor other than SAP	See the vendor's documentation for that driver.
Troubleshooting your ODBC connection	Check for a technical document that describes how to connect to your ODBC data source. Updated information about connectivity issues is available on the the Apeon Support Web site at https://support.appeon.com/ .

2.2 Preparing ODBC data sources

The first step in connecting to an ODBC data source is preparing the data source. This ensures that you are able to connect to the data source and use your data in InfoMaker.

You prepare to use a data source outside InfoMaker before you start the product, define the data source, and connect to it. The requirements differ for each data source, but in general, preparing to use a data source involves the following steps.

To prepare to use an ODBC data source with InfoMaker:

1. If network software is required to access the data source, make sure it is properly installed and configured at your site and on the client workstation.

2. If database software is required, make sure it is properly installed and configured on your computer or network server.
3. Make sure the required data files are present on your computer or network server.
4. Make sure the names of tables and columns you want to access follow standard SQL naming conventions.

Avoid using blank spaces or database-specific reserved words in table and column names. Be aware of the case-sensitivity options of the DBMS. It is safest to use all uppercase characters when naming tables and columns that you want to access in InfoMaker.

Backquote character not allowed as a delimiter

The online Help supplied for the DataDirect ODBC drivers indicates that you can use the backquote (`) character, also known as the grave character, as a delimiter for table and column names that do not follow standard SQL naming conventions. However, InfoMaker does not currently allow use of the backquote character as a delimiter for table and column names.

-
5. If your database requires it, make sure the tables you want to access have unique indexes.
 6. Install both of the following using the InfoMaker Setup program:
 - The ODBC driver that accesses your data source
 - The ODBC interface

2.3 Defining ODBC data sources

Each ODBC data source requires a corresponding ODBC driver to access it. When you define an ODBC data source, you provide information about the data source that the driver requires in order to connect to it. Defining an ODBC data source is often called configuring the data source.

After you prepare to use the data source, you must define it using Microsoft's ODBC Data Source Administrator utility. This utility can be accessed from the Control Panel in Windows or InfoMaker's Database painter.

The rest of this section describes what you need to know to define an ODBC data source in order to access it in the InfoMaker development environment.

2.3.1 How InfoMaker accesses the data source

When you access an ODBC data source in InfoMaker, there are several initialization files and registry entries on your computer that work with the ODBC interface and driver to make the connection.

2.3.1.1 PBODB190 initialization file

Contents

PBODB190.INI is installed in the Apeon\Shared\PowerBuilder or Apeon\Shared\PowerBuilder\x64 directory. InfoMaker uses PBODB190.INI to maintain access to extended functionality in the back-end DBMS, for which ODBC does not provide an API call. Examples of extended functionality are SQL syntax or DBMS-specific function calls.

Editing

In most cases, you do not need to edit PBODB190.INI. In certain situations, however, you might need to add functions to PBODB190.INI for your back-end DBMS.

For instructions, see [Adding Functions to the PBODB190 Initialization File](#).

2.3.1.2 ODBCINST registry entries

Contents

The ODBCINST initialization information is located in the HKEY_LOCAL_MACHINE\SOFTWARE\ODBC\ODBCINST.INI registry key. When you install an ODBC-compliant driver supplied by SAP or another vendor, ODBCINST.INI is automatically updated with a description of the driver.

This description includes:

- The DBMS or data source associated with the driver
- The drive and directory of the driver and setup DLLs (for some data sources, the driver and setup DLLs are the same)
- Other driver-specific connection parameters

Editing

You do not need to edit the registry key directly to modify connection information. If your driver uses the information in the ODBCINST.INI registry key, the key is automatically updated when you install the driver. This is true whether the driver is supplied by SAP or another vendor.

2.3.1.3 ODBC registry entries

Contents

ODBC initialization information is located in the HKEY_CURRENT_USER\SOFTWARE\ODBC\ODBC.INI registry key. When you define a data source for a particular ODBC driver, the driver writes the values you specify in the ODBC setup dialog box to the ODBC.INI registry key.

The ODBC.INI key contains a subkey named for each defined data source. Each subkey contains the values specified for that data source in the ODBC setup dialog box. The values might vary for each data source but generally include the following:

- Database
- Driver
- Optional description

- DBMS-specific connection parameters

Editing

Do not edit the ODBC subkey directly to modify connection information. Instead, use a tool designed to define ODBC data sources and the ODBC configuration automatically, such as the ODBC Data Source Administrator.

2.3.1.4 Database profiles registry entry

Contents

Database profiles for all data sources are stored in the registry in HKEY_CURRENT_USER \SOFTWARE\Sybase\PowerBuilder\18.0\DatabaseProfiles.

Editing

You should not need to edit the profiles directly to modify connection information. These files are updated automatically when InfoMaker creates the database profile as part of the ODBC data source definition.

You can also edit the profile in the Database Profile Setup dialog box or complete the Database Preferences property sheet in InfoMaker to specify other connection parameters stored in the registry. (For instructions, see [Setting Additional Connection Parameters](#))

Example

The following example shows a portion of the database profile for the PB Demo DB data source:

```
DBMS=ODBC
Database=PB Demo DB
UserId=dba
DatabasePassword=
LogPassword=
ServerName=
LogId=
Lock=
DbParm=ConnectionString='DSN=PB Demo DB;UID=dba;PWD=sql '
Prompt=0
```

This registry entry example shows the two most important values in a database profile for an ODBC data source:

- DBMS

The DBMS value (ODBC) indicates that you are using the ODBC interface to connect to the data source.

- DBParm

The ConnectString DBParm parameter controls your ODBC data source connection. The connect string must specify the DSN (data source name) value, which tells ODBC which data source you want to access. When you select a database profile to connect to a data source, ODBC looks in the ODBC.INI registry key for a subkey that corresponds to the data source name in your profile. ODBC then uses the information in the subkey to load the required libraries to connect to the data source. The connect string can also contain the UID (user ID) and PWD (password) values needed to access the data source.

2.3.2 Defining multiple data sources for the same data

When you define an ODBC data source in InfoMaker, each data source name must be unique. You can, however, define multiple data sources that access the same data, as long as the data sources have unique names.

For example, assume that your data source is an SQL Anywhere database located in C:\SQL Anywhere\SALES.DB. Depending on your application, you might want to specify different sets of connection parameters for accessing the database, such as different passwords and user IDs.

To do this, you can define two ODBC data sources named Sales1 and Sales2 that specify the same database (C:\SQL Anywhere\SALES.DB) but use different user IDs and passwords. When you connect to the data source using a profile created for either of these data sources, you are using different connection parameters to access the same data.

Figure: Using two data sources to access a database

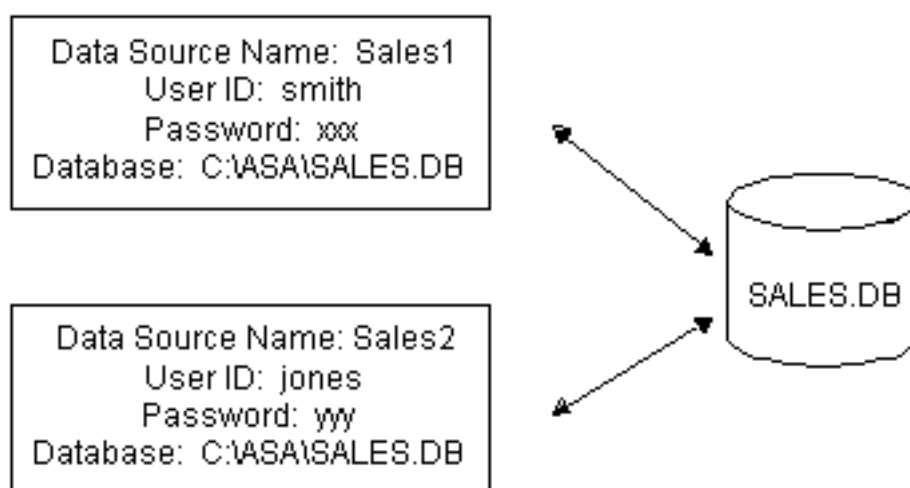

2.3.3 Displaying Help for ODBC drivers

The online Help for ODBC drivers in InfoMaker is provided by the driver vendors. It gives help on:

- Completing the ODBC setup dialog box to define the data source
- Using the ODBC driver to access the data source

2.3.3.1 Help for any ODBC driver

Use the following procedure to display vendor-supplied Help when you are in the ODBC setup dialog box for ODBC drivers supplied with InfoMaker.

To display Help for any ODBC driver:

1. Click the Help button in the ODBC setup dialog box for your driver.
A Help window displays, describing features in the setup dialog box.

2. Click the Contents button in the Help window to display additional Help topics for this driver.

Another Help window displays, listing the topics you can view.

3. Click an underlined topic to display its Help window.

2.3.4 Selecting an ODBC translator

What is an ODBC translator?

The ODBC drivers supplied with InfoMaker allow you to specify a translator when you define the data source. An ODBC translator is a DLL that translates data passing between an application and a data source. Typically, translators are used to translate data from one character set to another.

What you do

Follow these steps to select a translator for your ODBC driver.

To select a translator when using an ODBC driver:

1. In the ODBC setup dialog box for your driver, display the Select Translator dialog box.

The way you display the Select Translator dialog box for SAP-supplied ODBC drivers depends on the driver and Windows platform you are using. Click Help in your driver's setup dialog box for instructions on displaying the Select Translator dialog box.

In the Select Translator dialog box, the translators listed are determined by the values in your ODBCINST.INI registry key.

2. Select a translator to use from the Installed Translators list.

If you need help using the Select Translator dialog box, click Help.

3. Click OK.

The Select Translator dialog box closes and the driver performs the translation.

2.4 Defining the ODBC interface

To define a connection through the ODBC interface, you must create a database profile by supplying values for at least the basic connection parameters in the Database Profile Setup - ODBC dialog box. You can then select this profile at any time to connect to your data source in the development environment.

For information on how to define a database profile, see [Using database profiles](#).

2.5 SAP SQL Anywhere

This section describes how to prepare and define an SAP SQL Anywhere data source in order to connect to it using the SQL Anywhere ODBC driver.

SQL Anywhere includes two database servers -- a personal database server and a network database server. For information about using SQL Anywhere, see the SQL Anywhere documentation.

2.5.1 Supported versions for SQL Anywhere

The SQL Anywhere ODBC driver supports connection to local and remote databases created with the following:

- InfoMaker running on your computer
- SQL Anywhere 17.x
- SQL Anywhere 16.x
- SQL Anywhere 12.x

2.5.2 Basic software components for SQL Anywhere

The following figure shows the basic software components required to connect to an SQL Anywhere data source in InfoMaker.

Figure: Components of an SQL Anywhere connection

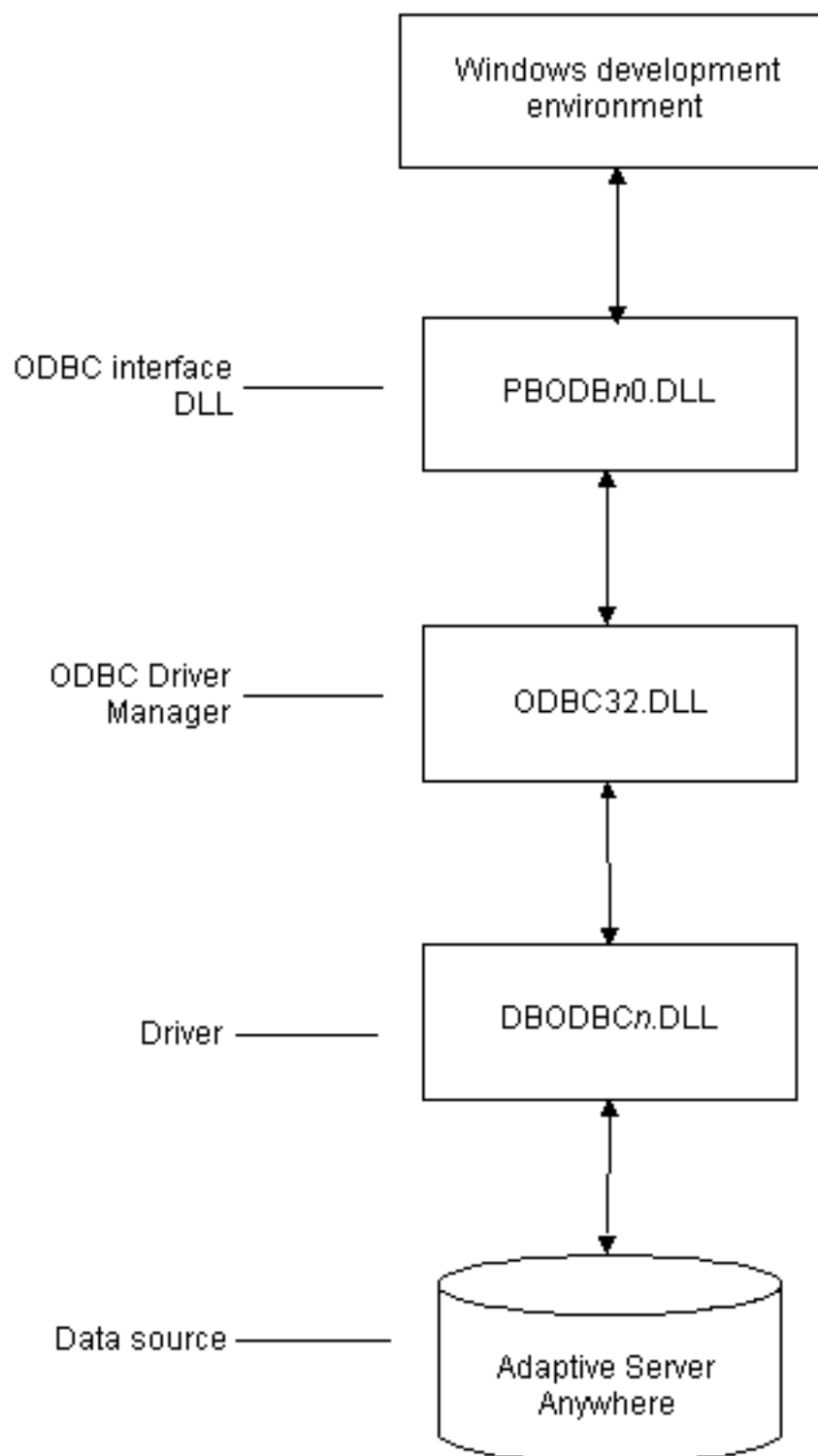

2.5.3 Preparing to use the SQL Anywhere data source

Before you define and connect to an SQL Anywhere data source in InfoMaker, follow these steps to prepare the data source.

To prepare an SQL Anywhere data source:

1. Make sure the database file for the SQL Anywhere data source already exists. You can create a new database by:

- Launching the Create SQL Anywhere Database utility. This utility can be accessed from the Utilities folder for the ODBC interface in the Database profile or Database painter when InfoMaker is running on your computer.

This method creates a local SQL Anywhere database on your computer, and also creates the data source definition and database profile for this connection. (For instructions, see the User's Guide.)

- Creating the database some other way, such as with InfoMaker running on another user's computer or by using SQL Anywhere outside InfoMaker. (For instructions, see the SQL Anywhere documentation.)

2. Make sure you have the log file associated with the SQL Anywhere database so that you can fully recover the database if it becomes corrupted.

If the log file for the SQL Anywhere database does not exist, the SQL Anywhere database engine creates it. However, if you are copying or moving a database from another computer or directory, you should copy or move the log file with it.

2.5.4 Defining the SQL Anywhere data source

When you create a local SQL Anywhere database, InfoMaker automatically creates the data source definition and database profile for you. Therefore, you need only use the following procedure to define an SQL Anywhere data source when you want to access an SQL Anywhere database not created using InfoMaker on your computer.

To define an SQL Anywhere data source for the SQL Anywhere driver:

1. Select Create ODBC Data Source from the list of ODBC utilities in the Database Profiles dialog box or the Database painter.
2. Select User Data Source and click Next.
3. On the Create New Data Source page, select the SQL Anywhere driver and click Finish.

The ODBC Configuration for SQL Anywhere dialog box displays:

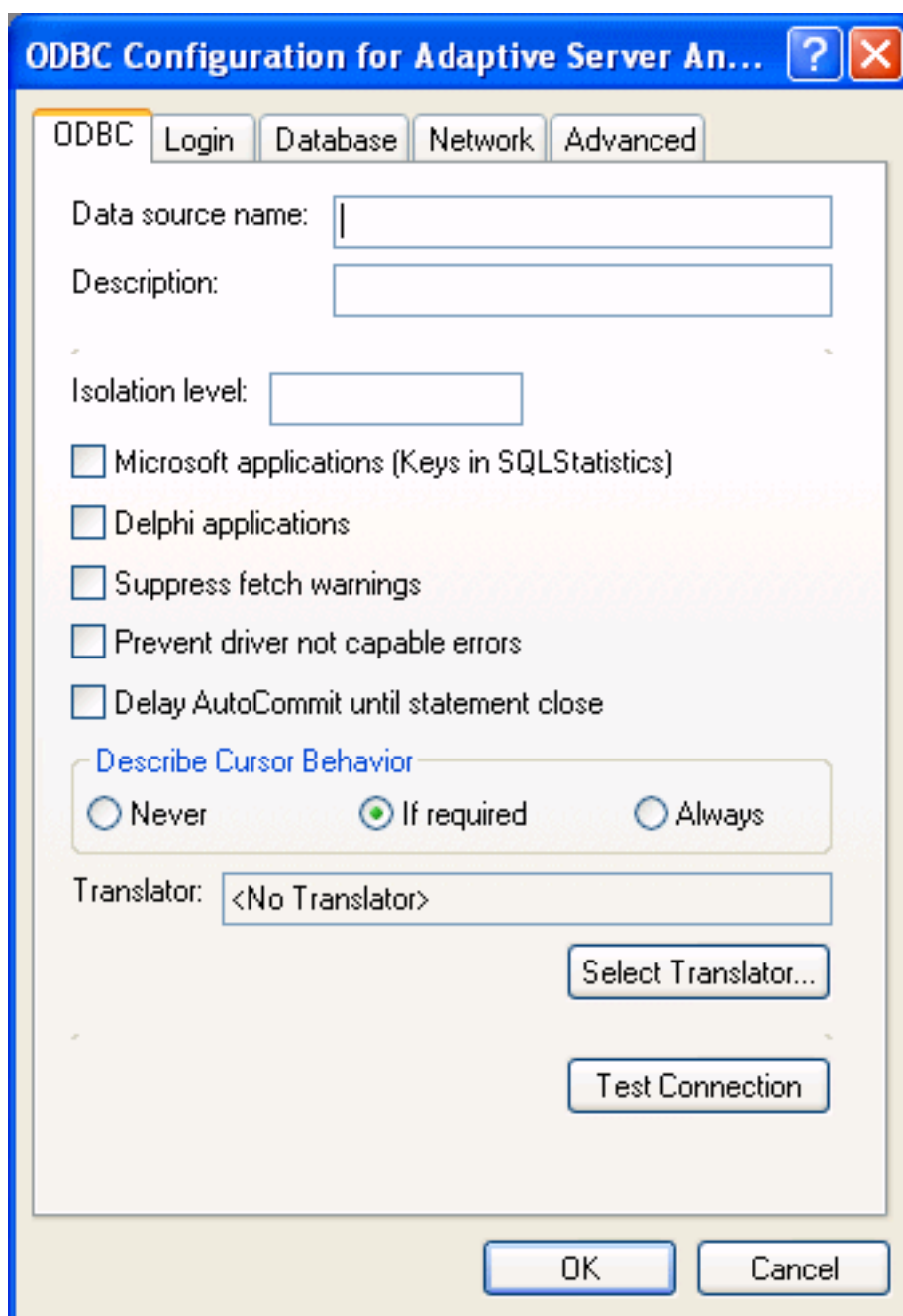

4. You must supply the following values:
- Data source name on the ODBC tab page
 - User ID and password on the Login tab page
 - Database file on the Database tab page

Use the Help button to get information about boxes in the dialog box.

Using the Browse button

When you use the Browse button to supply the Database File name (for example, SALES.DB), this name also displays without the extension in both the Data Source Name and Database Name boxes. This might change values that you previously supplied in these boxes. If you want to specify a different name for the data source or database, you can edit one or both of these boxes after using the Browse button.

5. (Optional) To select an ODBC translator to translate your data from one character set to another, click the Select button on the ODBC tab.

See [Selecting an ODBC translator](#).

6. Click OK to save the data source definition.

Specifying a Start Line value

When the SQL Anywhere ODBC driver cannot find a running personal or network database server using the PATH variable and Database Name setting, it uses the commands specified in the Start Line field to start the database servers.

Specify one of the following commands in the Start Line field on the Database tab, where n is the version of SQL Anywhere you are using.

Table 2.3:

Specify this command	To
dbengn.exe	Start the personal database server and the database specified in the Database File box
rtengn.exe	Start the runtime database server and the database specified in the Database File box

For information on completing the ODBC Configuration For SQL Anywhere dialog box, see the SQL Anywhere documentation.

2.5.5 Support for Transact-SQL special timestamp columns

When you work with an SQL Anywhere table in the Data Pipeline or Database painter, the default behavior is to treat any column named timestamp as an SQL Anywhere Transact-SQL special timestamp column.

Creating special timestamp columns

You can create a Transact-SQL special timestamp column in an SQL Anywhere table.

To create a Transact-SQL special timestamp column in an SQL Anywhere table in InfoMaker:

1. Give the name timestamp to any column having a timestamp datatype that you want treated as a Transact-SQL special timestamp column. Do this in one of the following ways:

- In the painter -- Select timestamp as the column name. (For instructions, see the User's Guide.)
 - In a SQL CREATE TABLE statement -- Follow the [CREATE TABLE example](#).
2. Specify timestamp as the default value for the column. Do this in one of the following ways:
 - In the painter -- Select timestamp as the default value for the column. (For instructions, see the User's Guide.)
 - In a SQL CREATE TABLE statement -- Follow the [CREATE TABLE example](#).
 3. If you are working with the table in the Data Pipeline painter, select the initial value exclude for the special timestamp column from the drop-down list in the Initial Value column of the workspace.

You must select exclude as the initial value to exclude the special timestamp column from INSERT or UPDATE statements.

For instructions, see the User's Guide.

CREATE TABLE example

The following CREATE TABLE statement defines an SQL Anywhere table named timesheet containing three columns: employee_ID (integer datatype), hours (decimal datatype), and timestamp (timestamp datatype and timestamp default value):

```
CREATE TABLE timesheet (  
    employee_ID INTEGER,  
    hours DECIMAL,  
    timestamp TIMESTAMP default timestamp )
```

Not using special timestamp columns

If you want to change the default behavior, you can specify that InfoMaker not treat SQL Anywhere columns named timestamp as Transact-SQL special timestamp columns.

To specify that InfoMaker not treat columns named timestamp as a Transact-SQL special timestamp column:

- Edit the SAP SQL Anywhere section of the PBODB190 initialization file to change the value of SQLSrvrTSName from 'Yes' to 'No'.

After making changes in the initialization file, you must reconnect to the database to have them take effect. See [Adding Functions to the PBODB190 Initialization File](#)

2.5.6 What to do next

For instructions on connecting to the ODBC data source, see [Connecting to a database](#).

2.6 PostgreSQL

PowerBuilder apps can connect with the PostgreSQL 10 (32-bit and 64-bit) (ANSI and Unicode) database through the PostgreSQL ODBC driver.

Note

The PostgreSQL database cannot be used as the data source for stored procedure; and PBODB190.INI must be configured first in order for connecting with the PostgreSQL database through ODBC interface. For how to configure the PBODB190.INI file, see [Adding Functions to the PBODB190 Initialization File](#).

3 Using the JDBC Interface

About this chapter

This chapter describes the JDBC interface and explains how to prepare to use this interface and how to define the JDBC database profile.

For more information

For more detailed information about JDBC, go to the Java web site.

3.1 About the JDBC interface

You can access a wide variety of databases through JDBC in InfoMaker. This section describes what you need to know to use JDBC connections to access your data in InfoMaker.

3.1.1 What is JDBC?

The JDBC API

Java Database Connectivity (JDBC) is a standard application programming interface (API) that allows a Java application to access any database that supports Structured Query Language (SQL) as its standard data access language.

The JDBC API includes classes for common SQL database activities so that you can open connections to databases, execute SQL commands, and process results. Consequently, Java programs have the capability to use the familiar SQL programming model of issuing SQL statements and processing the resulting data. The JDBC classes are included in Java 1.1+ and Java 2 as the `java.sql` package.

The JDBC API defines the following:

- A library of JDBC function calls that connect to a database, execute SQL statements, and retrieve results
- A standard way to connect and log in to a DBMS
- SQL syntax based on the X/Open SQL Call Level Interface or X/Open and SQL Access Group (SAG) CAE specification (1992)
- A standard representation for datatypes
- A standard set of error codes

How JDBC APIs are implemented

JDBC API implementations fall into two broad categories: those that communicate with an existing ODBC driver (a JDBC-ODBC bridge) and those that communicate with a native database API (a JDBC driver that converts JDBC calls into the communications protocol used by the specific database vendor). The InfoMaker implementation of the JDBC interface can be used to connect to any database for which a JDBC-compliant driver exists.

The InfoMaker JDB interface

A Java Virtual Machine (JVM) is required to interpret and execute the bytecode of a Java program. The InfoMaker JDB interface supports the Sun Java Runtime Environment (JRE) versions 1.2 and later.

3.1.2 Components of a JDBC connection

How a JDBC connection is made

In InfoMaker when you access a database through the JDBC interface, your connection goes through several layers before reaching the database. It is important to understand that each layer represents a separate component of the connection, and that each component might come from a different vendor.

Because JDBC is a standard API, InfoMaker uses the same interface to access every JDBC-compliant database driver.

The following figure shows the general components of a JDBC connection.

Figure: Components of a JDBC connection

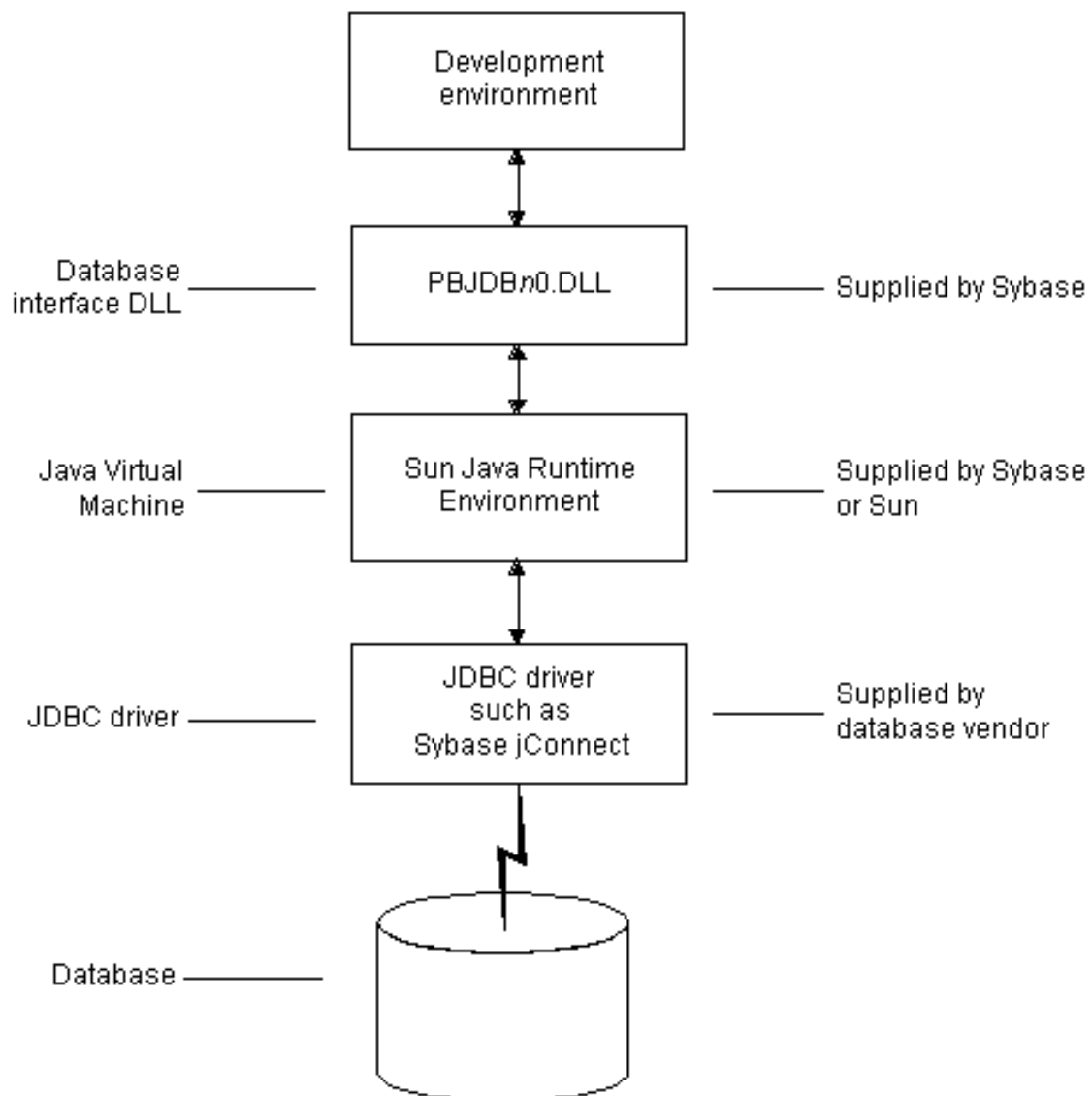

The JDBC DLL

InfoMaker provides the pbjdb190.dll. This DLL runs with the Sun Java Runtime Environment (JRE) versions 1.1 and later.

InfoMaker Java package

InfoMaker includes a small package of Java classes that gives the JDBC interface the level of error-checking and efficiency (SQLException catching) found in other InfoMaker interfaces. The package is called `pbjdbc12190.jar` and is found in `Apeon\Shared\PowerBuilder`.

The Java Virtual Machine

The Java Virtual Machine (JVM) is a component of Java development software. When you install InfoMaker, the Sun Java Development Kit (JDK), including the Java Runtime Environment (JRE), is installed on your system in `Apeon\Shared\PowerBuilder`. For InfoMaker 2017 and later, JDK 1.6 is installed. This version of the JVM is started when you use a JDBC connection or any other process that requires a JVM and is used throughout the InfoMaker session.

If you need to use a different JVM, see the instructions in [Preparing to use the JDBC interface](#). For more information about how the JVM is started, see the chapter on deploying your application in the User's Guide.

The JDBC drivers

The JDBC interface can communicate with any JDBC-compliant driver including SAP Sybase jConnect for JDBC and the Oracle and IBM Informix JDBC drivers. These drivers are native-protocol, all-Java drivers -- that is, they convert JDBC calls into the SQL syntax supported by the databases.

Accessing Unicode data

Using the ODBC interface, InfoMaker can connect, save, and retrieve data in both ANSI/DBCS and Unicode databases but does not convert data between Unicode and ANSI/DBCS. When character data or command text is sent to the database, InfoMaker sends a Unicode string. The driver must guarantee that the data is saved as Unicode data correctly. When InfoMaker retrieves character data, it assumes the data is Unicode.

A Unicode database is a database whose character set is set to a Unicode format, such as UTF-8, UTF-16, UCS-2, or UCS-4. All data must be in Unicode format, and any data saved to the database must be converted to Unicode data implicitly or explicitly.

A database that uses ANSI (or DBCS) as its character set might use special datatypes to store Unicode data. These datatypes are NCHAR, NVARCHAR, and NVARCHAR2. Columns with this datatype can store only Unicode data. Any data saved into such a column must be converted to Unicode explicitly. This conversion must be handled by the database server or client.

3.1.3 JDBC registry entries

When you access data through the InfoMaker JDBC interface, InfoMaker uses an internal registry to maintain definitions of SQL syntax, DBMS-specific function calls, and default DBParm parameter settings for the back-end DBMS. This internal registry currently includes subentries for SQL Anywhere, Adaptive Server Enterprise, and Oracle databases.

In most cases you do not need to modify the JDBC entries. However, if you do need to customize the existing entries or add new entries, you can make changes to the system registry by editing the registry directly or executing a registry file. Changes you introduce in the system registry override the InfoMaker internal registry entries. See the `egreg.txt` file in `Apeon\Shared\PowerBuilder` for an example of a registry file you could execute to change entry settings.

3.1.4 Supported versions for JDBC

The InfoMaker JDBC interface uses the `pbjdb190.dll` to access a database through a JDBC driver.

To use the JDBC interface to access the jConnect driver, use jConnect Version 4.2 or higher or jConnect Version 5.2 or higher. For information on jConnect, see your SAP documentation.

To use the JDBC interface to access the Oracle JDBC driver, use Oracle 8 JDBC driver Version 8.0.4 or higher. For information on the Oracle JDBC driver, see your Oracle documentation.

3.1.5 Supported JDBC datatypes

Like ODBC, the JDBC interface compiles, sorts, presents, and uses a list of datatypes that are native to the back-end database to emulate as much as possible the behavior of a native interface.

3.2 Preparing to use the JDBC interface

Before you define the interface and connect to a database through the JDBC interface, follow these steps to prepare the database for use:

1. Configure the database server for its JDBC connection and install its JDBC-compliant driver and network software.
2. Install the JDBC driver.
3. Set or verify the settings in the CLASSPATH environment variable and the Java tab of the System Options dialog box.

Step 1: Configure the database server

You must configure the database server to make JDBC connections as well as install the JDBC driver and network software.

To configure the database server for its JDBC connection:

1. Make sure the database server is configured to make JDBC connections. For configuration instructions, see your database vendor's documentation.
2. Make sure the appropriate JDBC driver software is installed and running on the database server.

The driver vendor's documentation should provide the driver name, URL format, and any driver-specific properties you need to specify in the database profile. For notes about the jConnect driver, see [Configuring the jConnect driver](#).

3. Make sure the required network software (such as TCP/IP) is installed and running on your computer and is properly configured so that you can connect to the database server at your site.

You must install the network communication driver that supports the network protocol and operating system platform you are using.

For installation and configuration instructions, see your network or database administrator.

Step 2: Install the JDBC driver

In the InfoMaker Setup program, select the Typical install, or select the Custom install and select the JDBC driver.

Step 3: Set or verify the settings in the CLASSPATH variable and Java tab

Set or verify that the settings in the PATH and CLASSPATH environment variables point to the appropriate, fully-qualified file names.

If you are using the JDK installed with InfoMaker, you do not need to make any changes to these environment variables.

If you are using JDK 1.2 or later, you do not need to include any Sun Java VM packages in your CLASSPATH variable, but your PATH environment variable must include an entry for the Sun Java VM library, jvm.dll (for example, path\JDK122\JRE\bin\classic).

Configuring the jConnect driver

If you are using the SAP Sybase jConnect driver, make sure to complete the required configuration steps such as installing the JDBC stored procedures in Adaptive Server databases. Also, verify that the CLASSPATH environment variable on your machine includes an entry pointing to the location of the jConnect driver. For example, if you are using jConnect 5.5, you should include an entry similar to the following:

```
C:\Program Files\SAP\Shared\jConnect-5_5\classes\jconn2.jar
```

For more information about configuring jConnect, see the jConnect for JDBC documentation.

3.3 Defining the JDBC interface

Defining the profile

To define a connection through the JDBC interface, you must create a database profile by supplying values for at least the basic connection parameters in the Database Profile Setup - JDBC dialog box. You can then select this profile at any time to connect to your database in the development environment.

For information on how to define a database profile, see [Using database profiles](#).

Specifying connection parameters

To provide maximum flexibility (as provided in the JDBC API), the JDBC interface supports database connections made with different combinations of connection parameters:

- Driver name, URL, and Properties

You should specify values for this combination of connection parameters if you need to define driver-specific properties. When properties are defined, you must also define the user ID and password in the properties field.

For example, when connecting to the jConnect driver, the following values should be entered in the Driver-Specific Properties field:

```
SQLINITSTRING=set TextSize 32000; user=system;password=manager;
```

- Driver name, URL, User ID, and Password

You should specify values for this combination of connection parameters if you do not need to define any driver-specific properties.

```
Driver Name: com.sybase.jdbc.SybDriver
URL:        jdbc:sybase:Tds:localhost:2638
Login ID:   dba
Password:   sql
```

- Driver name and URL

You should specify values for this combination of connections parameters when the user ID and password are included as part of the URL.

For example, when connecting to the Oracle JDBC driver, the URL can include the user ID and password:

```
jdbc:oracle:thin:userid/password@host:port:dbname
```

Specifying properties when connecting to jConnect

If you plan to use the blob datatype in InfoMaker, you should be aware that jConnect imposes a restriction on blob size. Consequently, before you make your database connection from InfoMaker, you might want to reset the blob size to a value greater than the maximum size you plan to use.

To set blob size, define the jConnect property `SQLINITSTRING` in the Driver-Specific Properties box on the Connection page. The `SQLINITSTRING` property is used to define commands to be passed to the back-end database server:

```
SQLINITSTRING=set TextSize 32000;
```

Remember that if you define a property in the Driver-Specific Properties box, you must also define the user ID and password in this box.

Specifying the appropriate Java Virtual Machine (JVM)

Since the JDB interface supports several JVMs, you must specify which version of the JVM you want to use. For consistent behavior, the same version of the JVM used during development should be used at runtime.

Set the JavaVM DBParm on the Options tab page to select the appropriate JVM. The default value is JRE 1.4. The following table lists the supported JVMs and their corresponding JavaVM DBParm value.

Table 3.1: Available Java VMs and JavaVM DBParm values

JVM	DBParm Value
Sun JRE 1.2	Sun1.2
Sun JRE 1.3	Sun1.3
Sun JRE 1.4	Sun1.4

4 Using the OLE DB interface

About this chapter

This chapter describes the OLE DB interface and then explains how to prepare to use this interface and how to define the OLE DB database profile.

For more information

This chapter gives general information about using the OLE DB interface. For more detailed information:

- See the Data Access section in the Microsoft MSDN library.
- Use the online Help provided by the data provider vendor.
- Check to see if there is a technical document that describes how to connect to your OLE DB data provider. Any updated information about connectivity issues is available from the Apeon Support Web site at <https://support.appeon.com/>.

4.1 About the OLE DB interface

You can access a wide variety of data through OLE DB data providers in InfoMaker. This section describes what you need to know to use OLE DB connections to access your data in InfoMaker.

Supported OLE DB data providers

For a complete list of the OLE DB data providers supplied with InfoMaker and the data they access, see "Supported Database Interfaces" in online Help.

4.1.1 What is OLE DB?

OLE DB API

OLE DB is a standard application programming interface (API) developed by Microsoft. It is a component of Microsoft's Data Access Components software. OLE DB allows an application to access a variety of data for which OLE DB data providers exist. It provides an application with uniform access to data stored in diverse formats, such as indexed-sequential files like Btrieve, personal databases like Corel Paradox, productivity tools such as spreadsheets and electronic mail, and SQL-based DBMSs.

The OLE DB interface supports direct connections to SQL-based databases.

Accessing data through OLE DB

Applications like InfoMaker that provide an OLE DB interface can access data for which an OLE DB data provider exists. An OLE DB data provider is a dynamic link library (DLL) that implements OLE DB function calls to access a particular data source.

The InfoMaker OLE DB interface can connect to any OLE DB data provider that supports the OLE DB object interfaces listed in the following table. An OLE DB data provider must support these interfaces in order to adhere to the Microsoft OLE DB 2.0 specification.

Table 4.1: Required OLE DB interfaces

IAccessor	IDBInitialize
-----------	---------------

IColumnsInfo	IDBProperties
ICommand	IOpenRowset
ICommandProperties	IRowset
ICommandText	IRowsetInfo
IDBCreateCommand	IDBSchemaRowset
IDBCreateSession	ISourcesRowset

In addition to the required OLE DB interfaces, InfoMaker also uses the OLE DB interfaces listed in the following table to provide further functionality.

Table 4.2: Additional OLE DB interfaces

OLE DB interface	Use in InfoMaker
ICommandPrepare	Preparing commands and retrieving column information.
IDBInfo	Querying the data provider for its properties. If this interface is not supported, database connections might fail.
IDBCommandWithParameters	Querying the data provider for parameters.
IErrorInfo	Providing error information.
IErrorRecords	Providing error information.
IIndexDefinition	Creating indexes for the extended attribute system tables. Also creating indexes in the Database painter. If this interface is not supported, InfoMaker looks for index definition syntax in the PBODB190.ini file.
IMultipleResults	Providing information.
IRowsetChange	Populating the extended attribute system tables when they are created. Also, for updating blobs.
IRowsetUpdate	Creating the extended attribute system tables.
ISQLErrorInfo	Providing error information.
ISupportErrorInfo	Providing error information.
ITableDefinition	<p>Creating the extended attribute system tables and also for creating tables in the Database painter. If this interface is not supported, the following behavior results:</p> <ul style="list-style-type: none"> • InfoMaker looks for table definition syntax in the PBODB190.ini file • InfoMaker catalog tables cannot be used • DDL and DML operations, like modifying columns or editing data in the database painter, do not function properly
ITransactionLocal	Supporting transactions. If this interface is not supported, InfoMaker defaults to AutoCommit mode.

Accessing Unicode data

Using the OLE DB interface, InfoMaker can connect, save, and retrieve data in both ANSI/DBCS and Unicode databases but does not convert data between Unicode and ANSI/DBCS. When character data or command text is sent to the database, InfoMaker sends a Unicode string. The data provider must guarantee that the data is saved as Unicode data correctly. When InfoMaker retrieves character data, it assumes the data is Unicode.

A Unicode database is a database whose character set is set to a Unicode format, such as UTF-8, UTF-16, UCS-2, or UCS-4. All data must be in Unicode format, and any data saved to the database must be converted to Unicode data implicitly or explicitly.

A database that uses ANSI (or DBCS) as its character set might use special datatypes to store Unicode data. These datatypes are NCHAR, NVARCHAR, and NVARCHAR2. Columns with this datatype can store only Unicode data. Any data saved into such a column must be converted to Unicode explicitly. This conversion must be handled by the database server or client.

4.1.2 Components of an OLE DB connection

When you access an OLE DB data provider in InfoMaker, your connection goes through several layers before reaching the data provider. It is important to understand that each layer represents a separate component of the connection, and that each component might come from a different vendor.

Because OLE DB is a standard API, InfoMaker uses the same interface to access every OLE DB data provider. As long as an OLE DB data provider supports the object interfaces required by InfoMaker, InfoMaker can access it through the OLE DB interface.

The following figure shows the general components of a OLE DB connection.

Figure: Components of an OLE DB connection

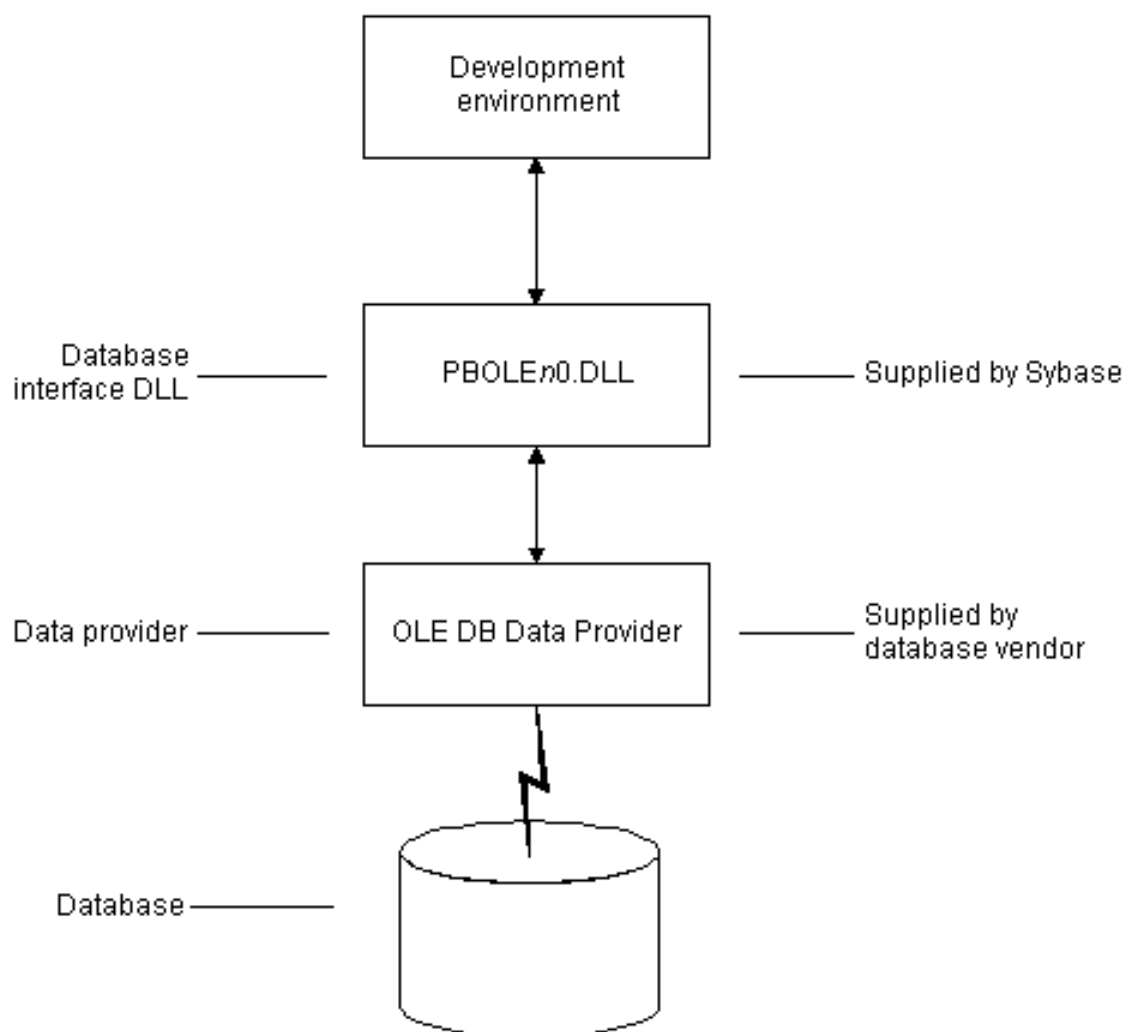

4.1.3 Obtaining OLE DB data providers

There are two ways you can obtain OLE DB data providers for use with InfoMaker:

- From SAP (recommended)

Install the OLE DB data providers shipped with InfoMaker. You can do this either when you first install InfoMaker or later.

- From another vendor

InfoMaker lets you access data with any OLE DB data provider obtained from a vendor other than SAP if that data provider supports the OLE DB object interfaces required by InfoMaker. In most cases, these drivers work with InfoMaker. However, SAP might not have tested the drivers to verify this.

4.1.4 Supported versions for OLE DB

The OLE DB interface uses a DLL named PBOLE190.dll to access a database through an OLE DB data provider.

Required OLE DB version

To use the OLE DB interface to access an OLE DB database, you must connect through an OLE DB data provider that supports OLE DB version 2.0 or later. For information on OLE DB specifications, see Microsoft Universal Data Access web site.

4.2 Preparing to use the OLE DB interface

Before you define the interface and connect to a data provider through the OLE DB:

1. Install and configure the database server, network, and client software.
2. Install the OLE DB interface and the OLE DB data provider that accesses your data source.
3. Install Microsoft's Data Access Components software on your machine.
4. If required, define the OLE DB data source.

Step 1: Install and configure the data server

You must install and configure the database server and install the network software and client software.

To install and configure the database server, network, and client software:

1. Make sure the appropriate database software is installed and running on its server.
You must obtain the database server software from your database vendor. For installation instructions, see your database vendor's documentation.
2. Make sure the required network software (such as TCP/IP) is installed and running on your computer and is properly configured so that you can connect to the data server at your site. You must install the network communication driver that supports the network protocol and operating system platform you are using.

For installation and configuration instructions, see your network or data source administrator.

3. If required, install the appropriate client software on each client computer on which InfoMaker is installed.

Client software requirements

To determine client software requirements, see your database vendor's documentation. To access supported remote Informix databases through the Informix data provider, you need Informix Connect for Windows platforms, version 2.x, or the Informix Client Software Development Kit for Windows platforms, version 2.x.

Step 2: Install the OLE DB interface and data provider

In the InfoMaker Setup program, select the Custom install and select the OLE DB provider that accesses your database. You can install one or more of the OLE DB data providers shipped with InfoMaker, or you can install data providers from another vendor later.

Step 3: Install the Microsoft Data Access Components software

The InfoMaker OLE DB interface requires the functionality of the Microsoft Data Access Components (MDAC) version 2.6 software.

To check the version of MDAC on your computer, download and run the MDAC Component Checker utility from the Microsoft Data Access Downloads page.

If MDAC version 2.6 is not installed, you can install it by running the file mdac_typ.exe found in the Support directory.

OLE DB data providers installed with MDAC

When you run the mdac_typ file, several Microsoft OLE DB data providers are automatically installed, including the providers for SQL Server (SQLOLEDB) and ODBC (MSDASQL).

Step 4: Define the OLE DB data source

Once the OLE DB data provider is installed, you might have to define the OLE DB data source the data provider will access. How you define the data source depends on the OLE DB data provider you are using and the vendor who provided it.

To define a data source for one of the OLE DB data providers shipped with InfoMaker, use the DataDirect OLE DB Administrator. This utility is named PBadm and can be found in SAP\Shared\DataDirect.

If you are connecting to an ODBC data provider (such as Microsoft's OLE DB Provider for ODBC), you must define the ODBC data source as you would if you were using a direct ODBC connection. To define an ODBC data source, use Microsoft's ODBC Data Source Administrator. This utility can be accessed through the Control Panel in Windows or through the Database painter.

4.3 Defining the OLE DB interface

Using the OLE DB Database Profile Setup

To define a connection through the OLE DB interface, you must create a database profile by supplying values for at least the basic connection parameters in the Database Profile Setup -- OLE DB dialog box. You can then select this profile anytime to connect to your data in the development environment.

For information on how to define a database profile, see [Using database profiles](#).

Specifying connection parameters

You must supply values for the Provider and Data Source connection parameters. Select a data provider from the list of installed data providers in the Provider drop-down list. The Data Source value varies depending on the type of data source connection you are making. For example:

- If you are using Microsoft's OLE DB Provider for ODBC to connect to the PB Demo DB, you select MSDASQL as the Provider value and enter the actual ODBC data source name (in this case PB Demo DB) as the Data Source value.

- If you are using Microsoft's OLE DB Provider for SQL Server, you select SQLOLEDB as the Provider value and enter the actual server name as the Data Source value. In the case of Microsoft SQL Server, you must also use the Extended Properties field to provide the database name (for example, Database=Pubs) since you can have multiple instances of a database.
- If you are using the PB OLE DB Provider to connect to an Oracle8i database, you select Sybase.Oracle8ADOProvider as the Provider value and enter the actual data source name (which you should have previously defined using the DataDirect OLE DB Administrator) as the Data Source value.

Using the Data Link API

The Data Link option allows you to access Microsoft's Data Link API, which allows you to define a file or use an existing file that contains your OLE DB connection information. A Data Link file is identified with the suffix .udl.

To launch this option, select the File Name check box on the Connection tab and double-click on the button next to the File Name box. (You can also launch the Data Link API in the Database painter by double-clicking on the Manage Data Links utility included with the OLE DB interface in the list of Installed Database Interfaces.)

For more information on using the Data Link API, see Microsoft Universal Data Access web site.

Using a Data Link file versus setting the DBParm parameters

If you use a Data Link file to connect to your data source, all other settings you make in the OLE DB Database Profile Setup dialog box are ignored.

5 Using the ADO.NET interface

About this chapter

This chapter describes the ADO.NET interface and explains how to prepare to use this interface and how to define an ADO.NET database profile.

For more information

This chapter gives general information about using the ADO.NET interface. For more detailed information:

- See the Data Access and .NET development sections in the Microsoft MSDN library.
- Use the online Help provided by the data provider vendor.
- Check to see if there is a technical document that describes how to connect to your ADO.NET data provider. Any updated information about connectivity issues is available from the Apeon Support Web site at <https://support.appeon.com/>.

5.1 About ADO.NET

ADO.NET is a set of technologies that provides native access to data in the Microsoft .NET Framework. It is designed to support an n-tier programming environment and to handle a disconnected data architecture. ADO.NET is tightly integrated with XML and uses a common data representation that can combine data from disparate sources, including XML.

One of the major components of ADO.NET is the .NET Framework data provider, which connects to a database, executes commands, and retrieves results.

Microsoft provides .NET Framework data providers for SQL Server and OLE DB with the .NET Framework, and data providers for ODBC and Oracle can be downloaded from the Microsoft Web site. You can also obtain .NET Framework data providers from other vendors, such as the .NET Framework Data Provider for Adaptive Server Enterprise from SAP.

To connect to a database using the InfoMaker ADO.NET database interface, you must use a .NET Framework data provider.

Accessing Unicode data

Using the ADO.NET interface, InfoMaker can connect, save, and retrieve data in both ANSI/DBCS and Unicode databases but does not convert data between Unicode and ANSI/DBCS. When character data or command text is sent to the database, InfoMaker sends a Unicode string. The data provider must guarantee that the data is saved as Unicode data correctly. When InfoMaker retrieves character data, it assumes the data is Unicode.

A Unicode database is a database whose character set is set to a Unicode format, such as UTF-8, UTF-16, UCS-2, or UCS-4. All data must be in Unicode format, and any data saved to the database must be converted to Unicode data implicitly or explicitly.

A database that uses ANSI (or DBCS) as its character set might use special datatypes to store Unicode data. These datatypes are NCHAR, NVARCHAR, and NVARCHAR2. Columns with this datatype can store only Unicode data. Any data saved into such a column must be converted to Unicode explicitly. This conversion must be handled by the database server or client.

5.2 About the InfoMaker ADO.NET database interface

You can use the InfoMaker ADO.NET database interface to connect to a data source such as Adaptive Server Enterprise, Oracle, and Microsoft SQL Server, as well as to data sources exposed through OLE DB and XML, in much the same way as you use the InfoMaker ODBC and OLE DB database interfaces.

Performance

You might experience better performance if you use a native database interface. The primary purpose of the ADO.NET interface is to support shared connections with other database constructs such as the .NET DataGrid in Appeon DataWindow .NET.

5.2.1 Components of an ADO.NET connection

When you access a database using ADO.NET in InfoMaker, your connection goes through several layers before reaching the database. It is important to understand that each layer represents a separate component of the connection, and that components might come from different vendors.

The InfoMaker ADO.NET interface consists of a driver (pbado190.dll) and a server (pbdata190.dll). Both DLLs must be deployed with an application that connects to a database using ADO.NET.

In this release, the InfoMaker database interface for ADO.NET supports the .NET namespace System.Data.OleDb, which is the .NET Framework data provider for OLE DB.

Additional .NET Framework data providers will be supported in future releases. Please see the release bulletin for the latest information.

The following figure shows the general components of an ADO.NET connection using the OLE DB .NET Framework data provider.

Figure: Components of an ADO.NET OLE DB connection

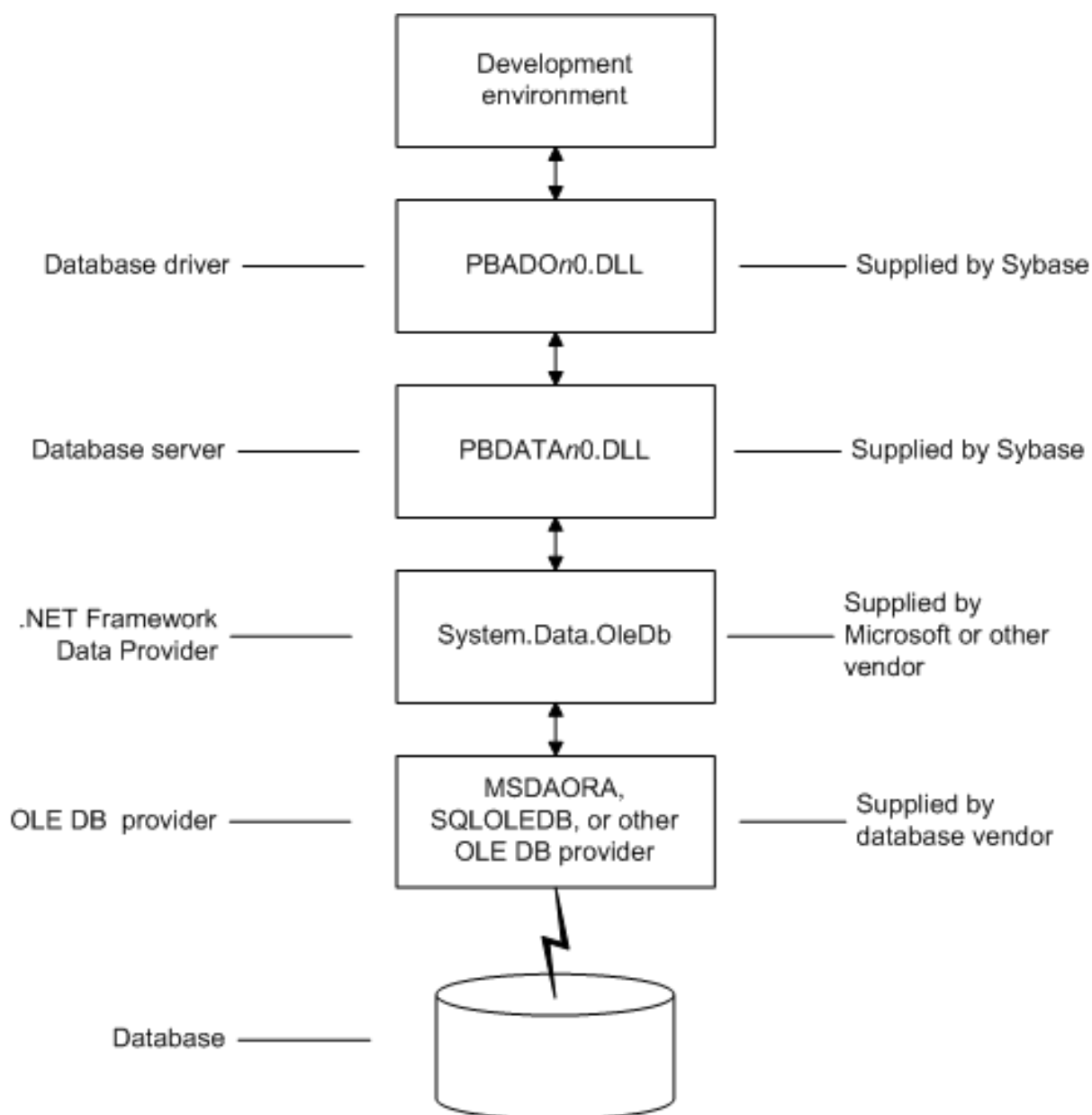

5.2.2 OLE DB data providers

When you use the .NET Framework data provider for OLE DB, you connect to a database through an OLE DB data provider, such as Microsoft's SQLOLEDB or MSDAORA or a data provider from another vendor.

The .NET Framework Data Provider for OLE DB does not work with the MSDASQL provider for ODBC, and it does not support OLE DB version 2.5 interfaces.

You can use any OLE DB data provider that supports the OLE DB interfaces listed in the following table with the OLE DB .NET Framework data provider. For more information about supported providers, see the topic on .NET Framework data providers in the Microsoft .NET Framework Developer's Guide.

Table 5.1: Required interface support for OLE DB data providers

OLE DB object	Required interfaces
OLE DB Services	IDataInitialize
DataSource	IDBInitialize IDBCreateSession IDBProperties IPersist
Session	ISessionProperties IOpenRowset
Command	ICommandText ICommandProperties
MultipleResults	IMultipleResults
RowSet	IRowset IAccessor IColumnsInfo IRowsetInfo (only required if DBTYPE_HCHAPTER is supported)
Error	IErrorInfo IErrorRecords

After you install the data provider, you might need to define a data source for it. To define a data source for one of the OLE DB data providers shipped with InfoMaker, use the DataDirect OLE DB Administrator. This utility is named PAdmin and can be found in SAP \Shared\DataDirect.

5.3 Preparing to use the ADO.NET interface

Before you define the interface and connect to a database using ADO.NET:

1. Install and configure the database server, network, and client software.
2. Install the ADO.NET interface.
3. Install Microsoft's Data Access Components version 2.6 or later software on your machine.

Step 1: Install and configure the data server

You must install and configure the database server and install the network software and client software.

To install and configure the database server, network, and client software:

1. Make sure the appropriate database software is installed and running on its server.

You must obtain the database server software from your database vendor. For installation instructions, see your database vendor's documentation.

2. Make sure the required network software (such as TCP/IP) is installed and running on your computer and is properly configured so that you can connect to the data server at your site. You must install the network communication driver that supports the network protocol and operating system platform you are using.

For installation and configuration instructions, see your network or data source administrator.

3. If required, install the appropriate client software on each client computer on which InfoMaker is installed.

Client software requirements

To determine client software requirements, see your database vendor's documentation.

Step 2: Install the ADO.NET interface

In the InfoMaker Setup program, select the Custom install and select the ADO.NET database interface. You can also install one or more of the OLE DB data providers shipped with InfoMaker, or you can install data providers from another vendor later.

Step 3: Install the Microsoft Data Access Components software

The InfoMaker ADO.NET interface requires the functionality of the Microsoft Data Access Components (MDAC) version 2.6 software.

To check the version of MDAC on your computer, download and run the MDAC Component Checker utility from the Microsoft Data Access Downloads page.

If MDAC version 2.6 is not installed, you can install it by running the file mdac_typ.exe found in the Support directory.

OLE DB data providers installed with MDAC

When you run the mdac_typ file, several Microsoft OLE DB data providers are automatically installed, including the provider for SQL Server, SQLOLEDB, which can be used with ADO.NET.

5.4 Defining the ADO.NET interface

Using the ADO.NET Database Profile Setup

To define a connection using the ADO.NET interface, you must create a database profile by supplying values for at least the basic connection parameters in the Database Profile Setup -- ADO.NET dialog box. You can then select this profile at any time to connect to your data in InfoMaker.

For information on how to define a database profile, see [Using database profiles](#).

Specifying connection parameters

You must supply a value for the Namespace and DataSource connection parameters and for the User ID and Password. When you use the System.Data.OleDb namespace, you must also select a data provider from the list of installed data providers in the Provider drop-down list.

The Data Source value varies depending on the type of data source connection you are making. For example:

- If you are using Microsoft's OLE DB Provider for SQL Server, you select SQLOLEDB as the Provider value and enter the actual server name as the Data Source value. In the case of Microsoft SQL Server, you must also use the Extended Properties field to provide the database name (for example, Database=Pubs) since you can have multiple instances of a database.
- If you are using the DataDirect OLE DB Provider to connect to an Oracle8i database, you select Sybase.Oracle8ADOProvider as the Provider value and enter the actual data source name (which you should have previously defined using the DataDirect OLE DB Administrator) as the Data Source value.

Using the Data Link API with OLE DB

The Data Link option allows you to access Microsoft's Data Link API, which allows you to define a file or use an existing file that contains your OLE DB connection information. A Data Link file is identified with the suffix .udl.

To launch this option, select the File Name check box on the Connection page and double-click the button next to the File Name box. (You can also launch the Data Link API in the Database painter by double-clicking the Manage Data Links utility included with the OLE DB interface in the list of Installed Database Interfaces.)

For more information on using the Data Link API, see Microsoft Universal Data Access web site.

Using a Data Link file versus setting the DBParm parameters

If you use a Data Link file to connect to your data source, all other settings you make in the OLE DB Database Profile Setup dialog box are ignored.

Part III. Working with Native Database Interfaces

This part describes how to set up and define database connections accessed through one of the native database interfaces.

6 Using Native Database Interfaces

About this chapter

This chapter describes the native database interfaces. For each supported interface, it then explains how to prepare to use the database and define any unique database interface parameters so that you can access your data.

For more information

This chapter gives general information about using each native database interface. For more detailed information:

- Check to see if there is a technical document that describes how to connect to your database. Any updated information about connectivity issues is available from the the Appeon Support Web site at <https://support.appeon.com/>.
- Ask your network or system administrator for assistance when installing and setting up the database server and client software at your site.

6.1 About native database interfaces

The native database interfaces provide native connections to many databases and DBMSs. This section describes how the native database interfaces access these databases.

For a complete list of the supported native database interfaces, see "Supported Database Interfaces" in online Help.

6.1.1 What is a native database interface?

A native database interface is a direct connection to your data in InfoMaker.

Each native database interface uses its own interface DLL to communicate with a specified database through a vendor-specific database API. For example, the Adaptive Server interface uses a DLL named PBSYC190.dll to access the database, while the Oracle database interface accesses the database through PBO90190.dll (Oracle9i), PBO10190.dll (Oracle10g), and PBO90190.dll (Oracle11g and Oracle12c).

In contrast, a standard database interface uses a standard API to communicate with the database. For example, InfoMaker can use a single-interface DLL (PBODB190.dll) to communicate with the ODBC Driver Manager and corresponding driver to access any ODBC data source.

6.1.2 Components of a database interface connection

When you use a native database interface to access a database, your connection goes through several layers before reaching the data. Each layer is a separate component of the connection and each component might come from a different vendor.

Figure: Components of a database connection

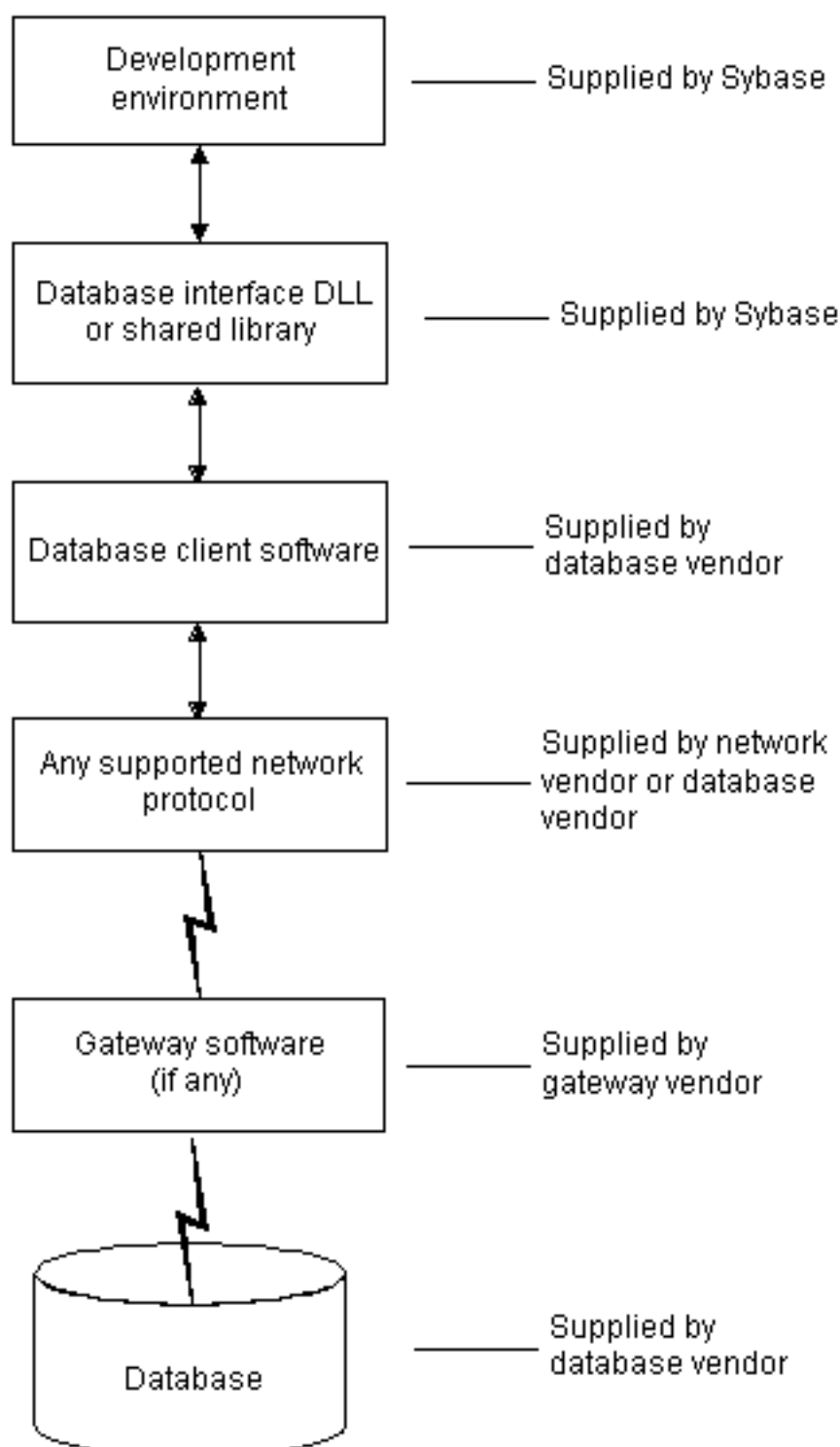

For diagrams showing the specific components of your connection, see "Basic software components" in the section in this chapter for your native database interface.

6.1.3 Using a native database interface

You perform several basic steps to use a native database interface to access a database.

About preparing to use the database

The first step in connecting to a database through a native database interface is to prepare to use the database. Preparing the database ensures that you will be able to access and use your data in InfoMaker.

You must prepare the database outside InfoMaker before you start the product, then define the database interface and connect to it. The requirements differ for each database -- but in general, preparing a database involves four basic steps.

To prepare to use your database with InfoMaker:

1. Make sure the required database server software is properly installed and configured at your site.
2. If network software is required, make sure it is properly installed and configured at your site and on the client computer so that you can connect to the database server.
3. Make sure the required database client software is properly installed and configured on the client computer. (Typically, the client computer is the one running InfoMaker.)

You must obtain the client software from your database vendor and make sure that the version you install supports all of the following:

The operating system running on the client computer

The version of the database that you want to access

The version of InfoMaker that you are running

4. Verify that you can connect to the server and database you want to access outside InfoMaker.

For specific instructions to use with your database, see "Preparing to use the database" in the section in this chapter for your native database interface.

About installing native database interfaces

After you prepare to use the database, you must install the native database interface that accesses the database. See the instructions for each interface for more information.

About defining native database interfaces

Once you are ready to access the database, you start InfoMaker and define the database interface. To define a database interface, you must create a database profile by completing the Database Profile Setup dialog box for that interface.

For general instructions, see [About creating database profiles](#). For instructions about defining database interface parameters unique to a particular database, see "Preparing to use the database" in the section in this chapter for your database interface.

6.2 Informix

This section describes how to use the native IBM Informix database interface in InfoMaker.

6.2.1 Supported versions for Informix

You can access the following Informix databases using the native Informix database interface:

- Informix 12.x
- Informix 10.x
- Informix Dynamic Server
- Informix-OnLine and Informix-SE version 9.x

InfoMaker provides the I10 interface in the PBIN10190.dll to connect through Informix-Connect version 10.x/12.x client software.

Accessing Unicode data

InfoMaker can connect, save, and retrieve data in ANSI/DBCS databases. The Informix native driver does not currently support access to Unicode databases.

6.2.2 Supported Informix datatypes

The Informix database interface supports the Informix datatypes listed in the following table in reports and forms.

Table 6.1: Supported datatypes for Informix

Byte (a maximum of 231 bytes)	Integer (4 bytes)
Character (1 to 32,511 bytes)	Money
Date	Real
DateTime	Serial
Decimal	SmallInt (2 bytes)
Float	Text (a maximum of 231 bytes)
Interval	VarChar (1 to 255 bytes)

Exceptions

Byte, text, and VarChar datatypes are not supported in Informix SE.

6.2.2.1 Informix DateTime datatype

The DateTime datatype is a contiguous sequence of boxes. Each box represents a component of time that you want to record. The syntax is:

```
DATETIME largest_qualifier TO smallest_qualifier
```

InfoMaker defaults to Year TO Fraction(5).

For a list of qualifiers, see your Informix documentation.

To create your own variation of the DateTime datatype:

1. In the Database painter, create a table with a DateTime column.

For instructions on creating a table, see the User's Guide.

2. In the Columns view, select Pending Syntax from the Objects or pop-up menu.

The Columns view displays the pending changes to the table definition. These changes execute only when you click the Save button to save the table definition.

3. Select Copy from the Edit or pop-up menu.

or

Click the Copy button.

The SQL syntax (or the portion you selected) is copied to the clipboard.

4. In the ISQL view, modify the DateTime syntax and execute the CREATE TABLE statement.

For instructions on using the ISQL view, see the User's Guide.

6.2.2.2 Informix Time datatype

The Informix database interfaces also support a time datatype. The time datatype is a subset of the DateTime datatype. The time datatype uses only the time qualifier boxes.

6.2.2.3 Informix Interval datatype

The interval datatype is one value or a sequence of values that represent a component of time. The syntax is:

```
INTERVAL largest_qualifier TO smallest_qualifier
```

InfoMaker defaults to Day(3) TO Day.

For more about interval datatypes, see your Informix documentation.

6.2.3 Basic software components for Informix

The following figure shows the basic software components required to access an Informix database using the native Informix database interfaces.

Figure: Components of an Informix connection

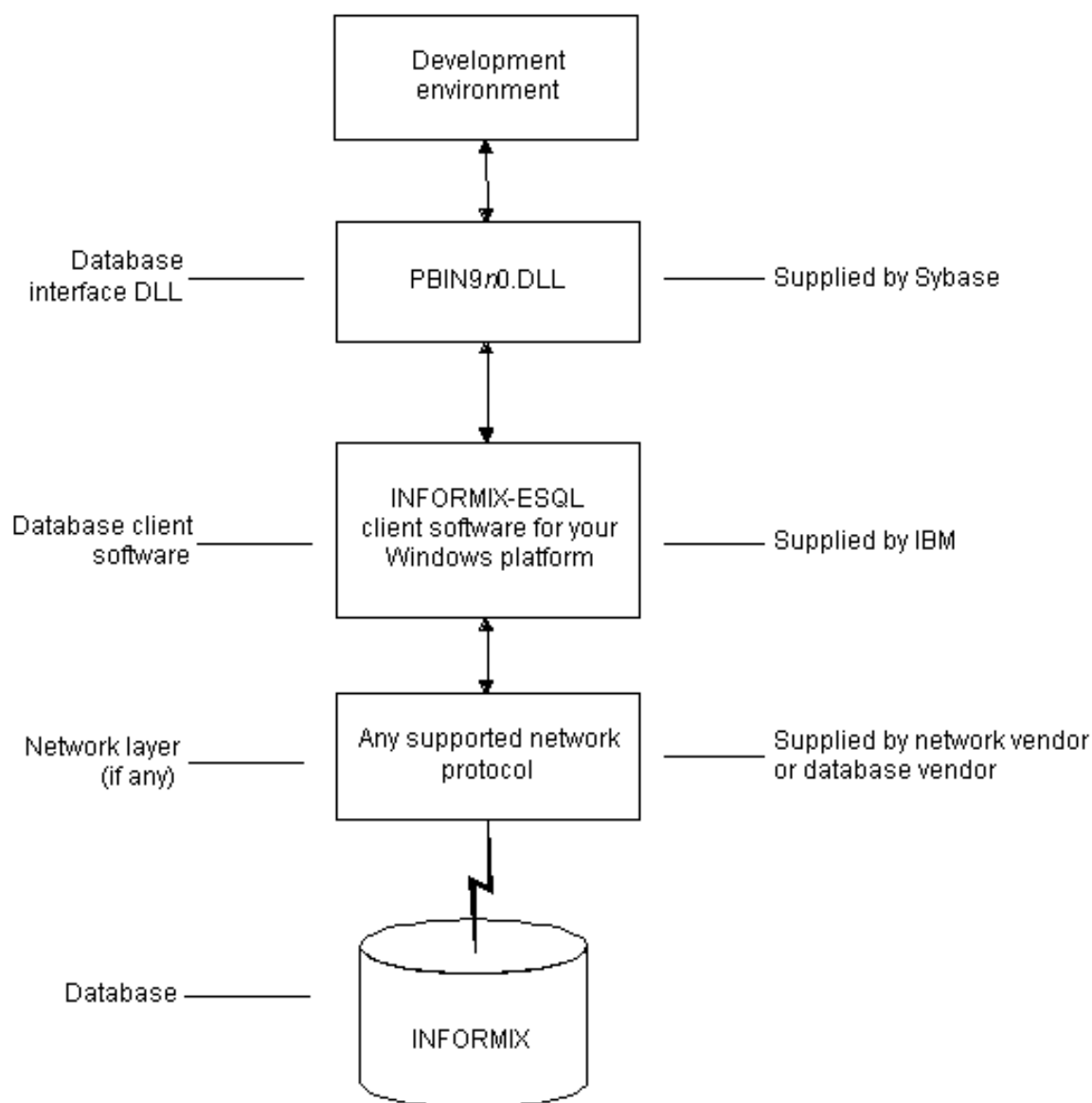

6.2.4 Preparing to use the Informix database

Before you define the database interface and connect to an Informix database in InfoMaker, follow these steps to prepare the database for use:

1. Install and configure the required database server, network, and client software.
2. Install the native Informix IN9 database interface.
3. Verify that you can connect to the Informix server and database outside InfoMaker.

Step 1: Install and configure the database server

You must install and configure the required database server, network, and client software for Informix.

To install and configure the required database server, network, and client software:

1. Make sure the Informix database server software and database network software is installed and running on the server specified in your database profile.

You must obtain the database server and database network software from Informix.
For installation instructions, see your Informix documentation.

2. Install the required Informix client software on each client computer on which InfoMaker is installed.

Install Informix Connect or the Informix Client SDK (which includes Informix Connect) and run the SetNet32 utility to configure the client registry settings.

You must obtain the Informix client software from IBM. Make sure the version of the client software you install supports all of the following:

The operating system running on the client computer

The version of the database that you want to access

The version of InfoMaker that you are running

For installation instructions, see your Informix documentation.

3. Make sure the Informix client software is properly configured so that you can connect to the Informix database server at your site.

For example, when you install Informix-Connect client software, it automatically creates the correct configuration file on your computer.

The configuration file contains default parameters that define your network configuration, network protocol, and environment variables. If you omit these values from the database profile when you define the native Informix database interface, they default to the values specified in your configuration file.

For instructions on setting up the Informix configuration file, see your Informix documentation.

4. If required by your operating system, make sure the directory containing the Informix client software is in your system path.

Step 2: Install the database interface

In the InfoMaker Setup program, select the Typical install, or select the native Informix database interface in the Custom install.

Step 3: Verify the connection

Make sure you can connect to the Informix server and database you want to access from outside InfoMaker.

To verify the connection, use any Windows-based utility (such as the Informix ILOGIN.EXE program) that connects to the database. When connecting, be sure to specify the same parameters you plan to use in your InfoMaker database profile to access the database.

For instructions on using ILOGIN.EXE, see your Informix documentation.

6.2.5 Defining the Informix database interface

To define a connection through an Informix database interface, you must create a database profile by supplying values for at least the basic connection parameters in the Database

Profile Setup - Informix IN9 dialog box. You can then select this profile at any time to connect to your database in the development environment.

For information on how to define a database profile, see [Using database profiles](#).

6.2.5.1 Specifying the server name

When you specify the server name value, you must use the following format to connect to the database through the Informix interface:

```
host_name@server_name
```

Table 6.2:

Parameter	Description
host_name	The name of the host computer running the Informix database server. This corresponds to the Informix HOSTNAME environment variable.
server_name	The name of the server containing the Informix database. This corresponds to the Informix SERVER environment variable.

For example, to use the IN9 interface to connect to an Informix database server named server01 running on a host machine named sales, type the host name (sales) in the Host Name box and the server name (server01) in the Server box on the Connection tab in the Database Profile Setup - Informix IN9 dialog box. InfoMaker saves this server name as sales@server01 in the database profile entry in the system registry.

6.2.6 What to do next

For instructions on connecting to the database, see [Connecting to a database](#)

6.3 Microsoft SQL Server

This section describes how to use the Microsoft SQL Server Native Client database interface in InfoMaker.

6.3.1 Supported versions for SQL Server

You can access Microsoft SQL Server 2008 R2, 2012, 2014, 2016, or 2017 databases using the SQL Native Client interface. The SQL Native Client interface uses a DLL named PBSNC190.dll to access the database. The interface uses the SQL Native Client (sqlncli.h and sqlncli.dll) on the client side and connects using OLE DB.

To take advantage of these features, you need to use the SNC interface. The SQL Server 2008 R2 or later SQL Native Client software must be installed on the client computer.

PBODB initialization file not used

Connections made directly through OLE DB use the PBODB initialization file to set some parameters, but connections made using the SNC interface do not depend on the PBODB initialization file.

6.3.2 Supported SQL Server datatypes

The SQL Native Client database interface supports the datatypes listed in the following table.

Table 6.3: Supported datatypes for Microsoft SQL Server 2005

Binary	Real
Bit	SmallDateTime
Character (fewer than 255 characters)	SmallInt
DateTime	SmallMoney
Decimal	Text
Float	Timestamp
Identity	TinyInt
Image	VarBinary(max)
Int	VarBinary(n)
Money	VarChar(max)
Numeric	VarChar(n)
NVarChar(max)	XML
NVarChar(n)	

The XML datatype is a built-in datatype in SQL Server 2005 that enables you to store XML documents and fragments in a SQL Server database. You can use this datatype as a column type when you create a table.

Additional datatypes are supported for SQL Server 2008. For more information, see [Support for new datatypes in SQL Server 2008](#).

In SQL Server 2005, the VarChar(max), NVarChar(max), and VarBinary(max) datatypes store very large values (up to 2³¹ bytes). You can use these datatypes to obtain metadata, define new columns, and query data from the columns. You can also use them to pipeline data.

6.3.3 Basic software components for Microsoft SQL Server

You must install the software components in the following figure to access a database with the SQL Native Client interface. Microsoft SQL Server Native Client software contains a SQL OLE DB provider and ODBC driver in a single DLL.

Figure: Components of a Microsoft SQL Server connection

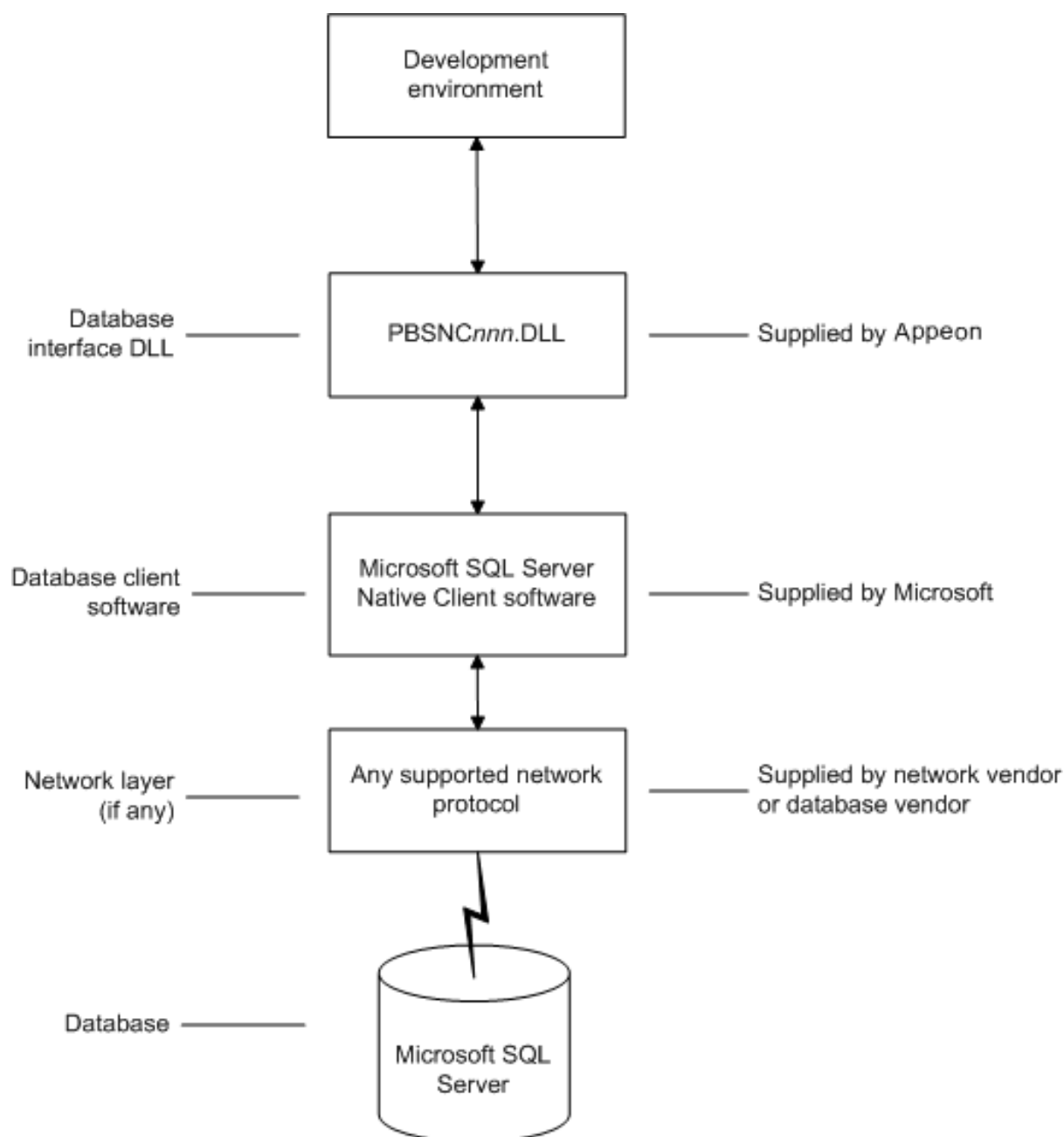

6.3.4 Preparing to use the SQL Server database

Before you define the database interface and connect to a Microsoft SQL Server database in InfoMaker, follow these steps to prepare the database for use:

1. Install and configure the required database server, network, and client software.
2. Install the SQL Native Client database interface.
3. Verify that you can connect to the Microsoft SQL Server server and database outside InfoMaker.

Step 1: Install and configure the database server

You must install and configure the database server, network, and client software for SQL Server.

To install and configure the database server, network, and client software:

1. Make sure the Microsoft SQL Server database software is installed and running on the server specified in your database profile.

You must obtain the database server software and required licenses from Microsoft Corporation. For installation instructions, see your Microsoft SQL Server documentation.

Upgrading from an earlier version of SQL Server

For instructions on upgrading to a later version of SQL Server or installing it alongside an earlier version, see your Microsoft SQL Server documentation.

2. If you are accessing a remote SQL Server database, make sure the required network software (for example, TCP/IP) is installed and running on your computer and is properly configured so that you can connect to the SQL Server database server at your site.

For installation and configuration instructions, see your network or database administrator.

3. Install the required Microsoft SQL Native Client software on each client computer on which InfoMaker is installed.

You must obtain the SQL Native Client software from Microsoft. Make sure the version of the client software you install supports all of the following:

The operating system running on the client computer

The version of the database that you want to access

The version of InfoMaker that you are running

For installation instructions, see your Microsoft SQL Server documentation.

4. Make sure the SQL Native Client client software is properly configured so that you can connect to the SQL Server database server at your site.

For configuration instructions, see your Microsoft SQL Server documentation.

5. Make sure the directory containing the SQL Native Client software is in your system path.

6. Make sure only one copy of the Sqlncli.dll file is installed on your computer.

Step 2: Install the database interface

In the InfoMaker Setup program, select the Custom install and select the SQL Native Client database interface.

Step 3: Verify the connection

Make sure you can connect to the SQL Server server and database you want to access from outside InfoMaker.

To verify the connection, use any Windows-based utility that connects to the database. When connecting, be sure to specify the same parameters you plan to use in your InfoMaker database profile to access the database.

6.3.5 Defining the SQL Server database interface

To define a connection through the SQL Native Client interface, you must create a database profile by supplying values for at least the basic connection parameters in the Database Profile Setup - SQL Native Client dialog box. You can then select this profile at any time to connect to your database in the development environment.

For information on how to define a database profile, see [Creating a database profile](#). For new features that require special settings in the database profile, see [SQL Server 2008 features](#). For a comparison of the database parameters you might have used with existing applications and those used with the SNC database interface, see [Migrating from the MSS or OLE DB database interfaces](#).

6.3.6 Migrating from the MSS or OLE DB database interfaces

In earlier releases of InfoMaker, the MSS native interface was provided for connection to Microsoft SQL Server. This native interface was based on Microsoft DB-LIB functionality, which is no longer supported by Microsoft and is not Unicode-enabled. The MSS interface was removed in InfoMaker 10.0.

Prior to the introduction of SQL Server 2005 and SQL Native Client, Microsoft recommended using the OLE DB database interface and MDAC to connect to SQL Server. You can continue to use this solution if you do not need to take advantage of new features in SQL Server 2005 or later versions.

This section provides a comparison between database parameters you might have used in existing applications with the parameters you can use with the SNC database interface.

MSS database parameters supported by SNC

The following table shows the database parameters and preferences that could be set in the Database Profile Setup dialog box for the discontinued MSS native database interface for Microsoft SQL Server, and indicates whether they are supported by the SNC interface.

The column on the left shows the tab page in the Database Profile Setup dialog box for MSS. The parameters and preferences may be on different tab pages in the SNC profile.

Table 6.4: MSS parameters supported by SNC

MSS	SNC
Connection tab:	
Language	Not supported
Lock	Supported (Transaction tab)
AutoCommit	Supported

MSS	SNC
CommitOnDisconnect	Supported
System tab:	
Log	Not supported
SystemProcs	Not supported
PBCatalogOwner	Supported
Transaction tab:	
Async	Not supported
DBGetTime	Not supported
CursorLock	Not supported
CursorScroll	Not supported
StaticBind	Supported
MaxConnect	Not supported
Syntax tab:	
DBTextLimit	Supported (as PBMaxTextSize on Transaction tab)
DateTimeAllowed	Not supported
OptSelectBlob	Not supported
Network tab:	
AppName	Supported (System tab)
Host	Supported (System tab)
PacketSize	Supported (System tab)
Secure	Supported (as TrustedConnection on General tab)

OLE DB database parameters supported by SNC

The following table shows the database parameters and preferences that can be set in the Database Profile Setup dialog box for the OLE DB standard interface for Microsoft SQL Server, and indicates whether they are supported by the SNC interface.

The column on the left shows the tab page in the Database Profile Setup dialog box for OLE DB. The parameters and preferences may be on different tab pages in the SNC profile.

Table 6.5: OLE DB parameters supported by SNC

OLE DB	SNC
Connection tab:	
Provider	Not supported
DataSource	Supported at runtime (as SQLCA.ServerName)

OLE DB	SNC
DataLink	Supported
Location	Not supported
ProviderString	Supported
System tab:	
PBCatalogOwner	Supported
ServiceComponents	Not supported
AutoCommit	Supported (General tab)
CommitOnDisconnect	Supported (General tab)
StaticBind	Supported (Transaction tab)
DisableBind	Supported (Transaction tab)
Init_Prompt	Not supported
TimeOut	Supported
LCID	Not supported
Transaction tab:	
Block	Supported
PBMaxBlobSize	Supported
Mode	Not supported
Lock	Supported
Syntax tab:	
DelimitIdentifier	Supported
IdentifierQuoteChar	Not supported
DateFormat	Supported
TimeFormat	Supported
DecimalSeparator	Supported
OJSyntax	Supported
Security tab:	
EncryptPassword	Not supported
CacheAuthentication	Not supported
PersistSensitive	Not supported
MaskPassword	Not supported
PersistEncrypted	Not supported
IntegratedSecurity	Supported (TrustedConnection on General tab)
ImpersonationLevel	Not supported
ProtectionLevel	Not supported

Additional database parameters

The SNC interface also supports the Encrypt, TrustServerCertificate, and SPCache parameters (on the System tab page) and the Identity parameter (on the Syntax tab page).

SPCache database parameter

You can control how many stored procedures are cached with parameter information by modifying the setting of the SPCache database parameter. The default is 100 procedures. To turn off caching of stored procedures, set SPCache to 0.

For more information about database parameters supported by the SNC interface, see Connection Reference.

6.3.7 SQL Server 2008 features

InfoMaker support for connections to SQL Server 2008 databases includes new database parameters as well as support for new SQL Server datatypes. To connect to SQL Server 2008 from InfoMaker, you must install the SNC 10.0 driver.

6.3.7.1 New database parameters

Provider parameter

The Provider DBParm parameter for the SQL Native Client (SNC) interface allows you to select the SQL Server version that you want to connect to. You can set this parameter in script to SQLNCLI (for the SNC 9.0 driver that connect to SQL Server 2005), to SQLNCLI10 (for the SNC 10.0 driver that connects to SQL Server 2008), or SQLNCLI11 (for the SNC 11.0 that connect to SQL Server 2012 or later). Otherwise, you can select one of these providers on the Connection tab of the Database Profile Setup dialog box for the SNC interface.

If you do not set or select a provider, the default selection is SQLNCLI (SNC 9.0 for SQL Server 2005). This allows existing SNC interface users to be able to migrate to InfoMaker 2017 and later without any modifications. If InfoMaker fails to connect with the SQLNCLI provider, it will attempt to connect to SQLNCLI10 provider. However, if you explicitly set the provider and the connection fails, InfoMaker displays an error message.

Failover parameter

The FailoverPartner DBParm parameter allows you to set the name of a mirror server, thereby maintaining database availability if a failover event occurs. You can also set the name of the mirror server on the System tab of the Database Profile Setup dialog box for the SNC interface.

When failover occurs, the existing InfoMaker connection to SQL Server is lost. The SNC driver releases the existing connection and tries to reopen it. If reconnection succeeds, InfoMaker triggers the failover event.

The following conditions must be satisfied for InfoMaker to trigger the failover event:

- The FailoverPartner DBParm is supplied at connect time
- The SQL Server database is configured for mirroring
- InfoMaker is able to reconnect successfully when the existing connection is lost

When failover occurs:

- InfoMaker returns an error code (998) and triggers the failover event
- Existing cursors cannot be used and should be closed
- Any failed database operation can be tried again
- Any uncommitted transaction is lost. New transactions must be started

6.3.7.2 Support for new datatypes in SQL Server 2008

Date and time datatypes

The following table lists new SQL Server 2008 date and time datatypes and the PowerScript datatypes that they map to:

Table 6.6:

SQL Server datatype	PowerScript datatype
DATE	Date
TIME	Time (Supports only up to 6 fractional seconds precision although SQL Server datatype supports up to 7 fractional seconds precision.)
DATETIME2	DateTime (Supports only up to 6 fractional seconds precision although SQL Server datatype supports up to 7 fractional seconds precision.)

The SQL Server 2008 DATETIMEOFFSET datatype is not supported in InfoMaker 2017 and later.

Precision settings

When you map to a table column in a SQL Server 2008 database, InfoMaker includes a column labeled "Dec" in the Column Specifications view of the Report painter, and a text box labeled "Fractional Seconds Precision" in the Column (Object Details) view of the Database painter. These fields allow you to list the precision that you want for the TIME and DATETIME2 columns.

The precision setting is for table creation only. When retrieving or updating the data in a column, InfoMaker uses only up to six decimal places precision for fractional seconds, even if you enter a higher precision value for the column.

Filestream datatype

The FILESTREAM datatype allows large binary data to be stored directly in an NTFS file system. Transact-SQL statements can insert, update, query, search, and back up FILESTREAM data.

The SQL Server Database Engine implements FILESTREAM as a Varbinary(max) datatype. The InfoMaker SNC interface maps the Varbinary(max) datatype to a BLOB datatype, so to retrieve or update filestream data, use the SelectBlob or UpdateBlob SQL statements,

respectively. To specify that a column should store data on the file system, you must include the FILESTREAM attribute in the Varbinary(max) column definition. For example:

```
CREATE TABLE FSTest (
  GuidCol1 uniqueidentifier ROWGUIDCOL NOT NULL
  UNIQUE DEFAULT NEWID(),
  IntCol2 int,
  varbinaryCol3 varbinary(max) FILESTREAM);
```

Do not use PowerScript file access functions with FILESTREAM data

You can access FILESTREAM data by declaring and using the Win32 API functions directly in InfoMaker applications. However, existing InfoMaker file access functions cannot be used to access FILESTREAM files. For more information about accessing FILESTREAM data using Win32 APIs, see the MSDN SQL Server Developer Center Web site at [http://msdn.microsoft.com/en-us/library/bb933877\(SQL.100\).aspx](http://msdn.microsoft.com/en-us/library/bb933877(SQL.100).aspx).

Using CLR datatypes in InfoMaker

The binary values of the .NET Common Language Runtime (CLR) datatypes can be retrieved from a SQL Server database as blobs that you could use in InfoMaker applications to update other columns in the database. If their return values are compatible with InfoMaker datatypes, you can use CLR datatype methods in PowerScript, dynamic SQL, embedded SQL or in report objects, because the SQL script is executed on the SQL Server side.

The CLR datatypes can also be mapped to Strings in PowerScript, but the retrieved data is a hexadecimal string representation of binary data.

You can use the ToString method to work with all datatypes that are implemented as CLR datatypes, such as the [HierarchyID datatype](#), [Spatial datatypes](#), and [User-defined types](#).

HierarchyID datatype

HierarchyID is a variable length, system datatype that can store values representing nodes in a hierarchical tree, such as an organizational structure. A value of this datatype represents a position in the tree hierarchy.

ISQL Usage

You can use HierarchyID columns with CREATE TABLE, SELECT, UPDATE, INSERT, and DELETE statements in the ISQL painter. For example:

```
CREATE TABLE Emp (
  EmpId int NOT NULL,
  EmpName varchar(20) NOT NULL,
  EmpNode hierarchyid NULL);
```

To insert HierarchyID data, you can use the canonical string representation of HierarchyID or any of the methods associated with the HierarchyID datatype as shown below.

```
INSERT into Emp VALUES (1, 'Scott',
  hierarchyid::GetRoot());
INSERT into Emp VALUES (2, 'Tom' , '/1/');

DECLARE @Manager hierarchyid
SELECT @Manager = hierarchyid::GetRoot() FROM Emp
INSERT into Emp VALUES (2, 'Tom',
  @Manager.GetDescendant(NULL,NULL));
```

```
DECLARE @Employee hierarchyid
SELECT @Employee = CAST('/1/2/3/4/' AS hierarchyid)
INSERT into Emp VALUES (2, 'Jim' , @Employee);
```

You cannot select the HierarchyID column directly since it has binary data, and the ISQL painter Results view does not display binary columns. However, you can retrieve the HierarchyID data as a string value using the ToString method of HierarchyID. For example:

```
Select EmpId, EmpName, EmpNode.ToString() from Emp;
```

You can also use the following methods on HierarchyID columns to retrieve its data: GetAncestor, GetDescendant, GetLevel, GetRoot, IsDescendant, Parse, and Repair. If one of these methods returns a HierarchyID node, then use ToString to convert the data to a string. For example:

```
Select EmpId, EmpName, EmpNode.GetLevel() from Emp;
Select EmpId, EmpName,
    EmpNode.GetAncestor(1).ToString() from Emp;
```

HierarchyID columns can be updated using a String value or a HierarchyID variable:

```
Update Emp Set EmpNode = '/1/2/' where EmpId=4;
Delete from Emp where EmpNode = '/1/2/';
```

PowerScript Usage

You can use HierarchyID columns in embedded SQL statements for SELECT, INSERT, UPDATE, and DELETE operations. HierarchyID data can be retrieved either as a String or as a Binary(Blob) datatype using the SelectBlob statement.

When using a String datatype to retrieve HierarchyID data, use the ToString method. Otherwise the data will be a hexadecimal representation of the binary HierarchyID value.

The following example shows how you can use HierarchyID methods in embedded SQL:

```
long id
String hid,name
Select EmpId, EmpName, EmpNode.ToString()
    into :id, :name, :hid
    from Emp where EmpId=3;
Select EmpId, EmpName, EmpNode.GetLevel()
    into :id, :name, :hid
    from Emp where EmpId=3;
Blob b
Selectblob EmpNode into :b from Emp where EmpId =2;
```

DataWindow Usage

Reports do not directly support the HierarchyID datatype. But you can convert the HierarchyID to a string using the ToString method or an associated HierarchyID method in the data source SQL. For example:

```
SELECT EmpId, EmpName, EmpNode.ToString() FROM Emp;
SELECT EmpId, EmpName, EmpNode.GetLevel() FROM Emp;
```

Spatial datatypes

Microsoft SQL Server 2008 supports two spatial datatypes: the geometry datatype and the geography datatype. In SQL Server, these datatypes are implemented as .NET Common Language Runtime (CLR) datatypes.

Although the InfoMaker SNC interface does not work with CLR datatypes, you can convert the spatial datatypes into strings (with the ToString function) and use them in PowerScript, in the ISQL painter, in embedded SQL, and in reports. This is similar to the way you use the HierarchyID datatype. The SelectBlob SQL statement also lets you retrieve binary values for these datatypes.

The geography and geometry datatypes support eleven different data objects, or instance types, but only seven of these types are instantiable: Points, LineStrings, Polygons, and the objects in an instantiable GeometryCollection (MultiPoints, MultiLineStrings, and MultiPolygons). You can create and work with these objects in a database, calling methods associated with them, such as STAsText, STArea, STGeometryType, and so on.

For example:

```
CREATE TABLE SpatialTable (id int IDENTITY (1,1),
  GeomCol geometry);
INSERT INTO SpatialTable (GeomCol) VALUES (
  geometry::STGeomFromText(
    'LINESTRING (100 100,20 180,180 180)',0));
select id, GeomCol.ToString() from SpatialTable;
select id, GeomCol.STAsText(),
  GeomCol.STGeometryType(),
  GeomCol.STArea() from SpatialTable;
```

User-defined types

User-defined types (UDTs) are implemented in SQL Server as CLR types and integrated with .NET. Microsoft SQL Server 2008 eliminates the 8 KB limit for UDTs, enabling the size of UDT data to expand dramatically.

Although the InfoMaker SNC interface does not directly support UDT datatypes, you can use the ToString method to retrieve data for UDTs in the same way as for other CLR datatypes such as HierarchyId or the spatial datatypes. However, if a UDT datatype is mapped to a String datatype in PowerScript, UDT binary values will be retrieved as hexadecimal strings. To retrieve or update data in binary form (blob) from a UDT, you can use the SelectBlob or UpdateBlob SQL statements, respectively.

You can use any of the associated methods of UDT or CLR datatypes that return compatible data (such as String, Long, Decimal, and so on) for InfoMaker applications.

6.3.7.3 T-SQL enhancements

MERGE statement

The MERGE Transact-SQL statement performs INSERT, UPDATE, or DELETE operations on a target table or view based on the results of a join with a source table. You can use MERGE statement in the ISQL painter and in PowerScript using dynamic SQL. For example

```
String mySQL
mySQL = "MERGE INTO a USING b ON a.keycol = b.keycol " &
  + "WHEN MATCHED THEN " &
  + "UPDATE SET col1 = b.col1,col2 = b.col2 " &
  + "WHEN NOT MATCHED THEN " &
  + "INSERT (keycol, col1, col2, col3)" &
  + "VALUES (b.keycol, b.col1, b.col2, b.col3) " &
  + "WHEN SOURCE NOT MATCHED THEN " &
  + "DELETE;"
EXECUTE IMMEDIATE :mySQL;
```

Using the MERGE statement in ISQL

A MERGE statement must be terminated by a semicolon. By default the ISQL painter uses a semicolon as a SQL terminating character, so to use a MERGE statement in ISQL, the terminating character must be changed to a colon (:), a forward slash (/), or some other special character.

Grouping sets

GROUPING SETS is an extension of the GROUP BY clause that lets you define multiple groupings in the same query. GROUPING SETS produce a single result set, making aggregate querying and reporting easier and faster. It is equivalent to a UNION ALL operation for differently grouped rows.

The GROUPING SETS, ROLLUP, and CUBE operators are added to the GROUP BY clause. A new function, GROUPING_ID, returns more grouping-level information than the existing GROUPING function. (The WITH ROLLUP, WITH CUBE, and ALL syntax is not ISO compliant and is therefore deprecated.)

The following example uses the GROUPING SETS operator and the GROUPING_ID function:

```
SELECT EmpId, Month, Yr, SUM(Sales) AS Sales
FROM Sales
GROUP BY GROUPING SETS((EmpId, ROLLUP(Yr, Month)));
SELECT COL1, COL2,
SUM(COL3) AS TOTAL_VAL,
GROUPING(COL1) AS C1,
GROUPING(COL2) AS C2,
GROUPING_ID(COL1, COL2) AS GRP_ID_VALUE
FROM TEST_TBL GROUP BY ROLLUP (COL1, COL2);
```

You can use the GROUPING SETS operator in the ISQL painter, in PowerScript (embedded SQL and dynamic SQL) and in reports (syntax mode).

Row constructors

Transact-SQL now allows multiple value inserts within a single INSERT statement. You can use the enhanced INSERT statement in the ISQL painter and in PowerScript (embedded SQL and dynamic SQL). For example:

```
INSERT INTO Employees VALUES ('tom', 25, 5),
('jerry', 30, 6), ('bok', 25, 3);
```

When including multiple values in a single INSERT statement with host variables, you must set the DisableBind DBParm to 1. If you use literal values as in the above example, you can insert multiple rows in a single INSERT statement regardless of the binding setting.

Compatibility level

In SQL Server 2008, the ALTER DATABASE statement allows you to set the database compatibility level (SQL Server version), replacing the sp_dbcmtlevel procedure. You can use this syntax in the ISQL painter and in PowerScript (dynamic SQL). For example:

```
ALTER DATABASE <database_name>
SET COMPATIBILITY_LEVEL = {80 | 90 | 100}
80 = SQL Server 2000
90 = SQL Server 2005
```

```
100 = SQL Server 2008
```

Compatibility level affects behaviors for the specified database only, not for the entire database server. It provides only partial backward compatibility with earlier versions of SQL Server. You can use the database compatibility level as an interim migration aid to work around differences in the behaviors of different versions of the database.

Table hints

The FORCESEEK table hint overrides the default behavior of the query optimizer. It provides advanced performance tuning options, instructing the query optimizer to use an index seek operation as the only access path to the data in the table or view that is referenced by the query. You can use the FORCESEEK table hint in the ISQL painter, in PowerScript (embedded SQL and dynamic SQL), and in reports (syntax mode).

For example:

```
Select ProductID, OrderQty from SalesOrderDetail
with (FORCESEEK);
```

6.3.7.4 Unsupported SQL Server 2008 features

The InfoMaker SNC interface does not support the User-Defined Table Type (a user-defined type that represents the definition of a table structure) that was introduced in SQL Server 2008.

6.3.8 Notes on using the SNC interface

SQL batch statements

The SNC interface supports SQL batch statements. However, they must be enclosed in a BEGIN...END block or start with the keyword DECLARE:

- Enclosed in a BEGIN...END block:

```
BEGIN
INSERT INTO t_1 values(1, 'sfdfs')
INSERT INTO t_2 values(1, 'sfdfs')
SELECT * FROM t_1
SELECT * FROM t_2
END
```

- Starting with the keyword DECLARE:

```
DECLARE @p1 int, @p2 varchar(50)
SELECT @p1 = 1
EXECUTE sp_4 @p1, @p2 OUTPUT
SELECT @p2 AS 'output'
```

You can run the batch of SQL statements in the Database painter. For example:

```
String batchSQL //contains a batch of SQL statements
DECLARE my_cursor DYNAMIC CURSOR FOR SQLSA ;
PREPARE SQLSA FROM :batchSQL ;
OPEN DYNAMIC my_cursor ;
//first result set
FETCH my_cursor INTO . . .
//second result set
FETCH my_cursor INTO . .
```

```

. . .
CLOSE my_cursor ;

```

Connection pooling

The SNC interface pools connections automatically using OLE DB pooling. To disable OLE DB pooling, type the following in the Extended Properties box on the Connection tab page in the Database Profile Setup dialog box:

```
OLE DB Services=-4
```

Triggers and synonyms in the Database painter

In the Objects view for SNC profiles in the Database painter, triggers display for tables in the Tables folder and Microsoft SQL Server 2005 synonyms display for tables and views.

6.4 Oracle

This section describes how to use the native Oracle database interfaces in InfoMaker.

6.4.1 Supported versions for Oracle

InfoMaker provides two Oracle database interfaces. These interfaces use different DLLs and access different versions of Oracle.

Table 6.7: Supported native database interfaces for Oracle

Oracle interface	DLL
O10 Oracle 10g	PBO10190.dll
ORA Oracle 11g/12c	PBORA190.dll

The ORA database interface allows you to connect to Oracle 11g/12c servers using Oracle 11g/12c Database Client or Oracle 11g/12c Instant Client. It includes partial support for the XMLType datatype that it maps to the PowerBuilder String datatype. It also supports session and connection pooling, load balancing, the Oracle Client Cache, setting of an application driver name, and access through a proxy. Oracle 11g clients can also connect to Oracle 10g servers.

The O10 database interface allows you to connect to Oracle 10g servers using Oracle 10g Database Client or Oracle 10g Instant Client. It supports BINARY_FLOAT and BINARY_DOUBLE datatypes and increased size limits for CLOB and NCLOB datatypes. Oracle 10g clients can connect to Oracle 10g servers.

For more information

Updated information about supported versions of databases might be available electronically on the the Apeon Support Web site at <https://support.appeon.com/> or in the InfoMaker Release Bulletin.

6.4.2 Supported Oracle datatypes

The Oracle database interfaces support the Oracle datatypes listed in the following table in reports:

Table 6.8: Supported datatypes for Oracle

Bfile	NChar (Oracle9i and later only)
Blob	Number
Char	NVarChar2 (Oracle9i and later only)
Clob	Raw
Date	TimeStamp (Oracle9i and later only)
Float	VarChar
Long	VarChar2
LongRaw	

Accessing Unicode data

Using the O90 database interface, InfoMaker can connect, save, and retrieve data in both ANSI/DBCS and Unicode databases but does not convert data between Unicode and ANSI/DBCS. When character data or command text is sent to the database, InfoMaker sends a Unicode string. The driver must guarantee that the data is saved as Unicode data correctly. When InfoMaker retrieves character data, it assumes the data is Unicode.

Using the O84 database interface, InfoMaker detects whether the Oracle client variable `NS_LANG` is set. If the variable is set to a value that requires UTF-8 or DBCS characters, InfoMaker converts command text (such as `SELECT * FROM emp`) to the appropriate character set before sending the command to the database. However, if `DisableBind` is set to 0 (the default), InfoMaker always binds string data as Unicode data.

A Unicode database is a database whose character set is set to a Unicode format, such as UTF-8, UTF-16, UCS-2, or UCS-4. All data must be in Unicode format, and any data saved to the database must be converted to Unicode data implicitly or explicitly.

A database that uses ANSI (or DBCS) as its character set might use special datatypes to store Unicode data. These datatypes are `NCHAR`, `NVARCHAR`, and `NVARCHAR2`. Columns with this datatype can store only Unicode data. Any data saved into such a column must be converted to Unicode explicitly. This conversion must be handled by the database server or client.

TimeStamp datatype

The Oracle9i TimeStamp datatype is an extension of the Date datatype. It stores the year, month, and day of the Date value plus hours, minutes, and seconds:

```
Timestamp[fractional_seconds_precision]
```

The `fractional_seconds_precision` value is optional and provides the number of digits for indicating seconds. The range of valid values for use with InfoMaker is 0-6.

6.4.3 Basic software components for Oracle

You must install the software components in the following figure to access an Oracle database in InfoMaker.

Figure: Components of an Oracle connection

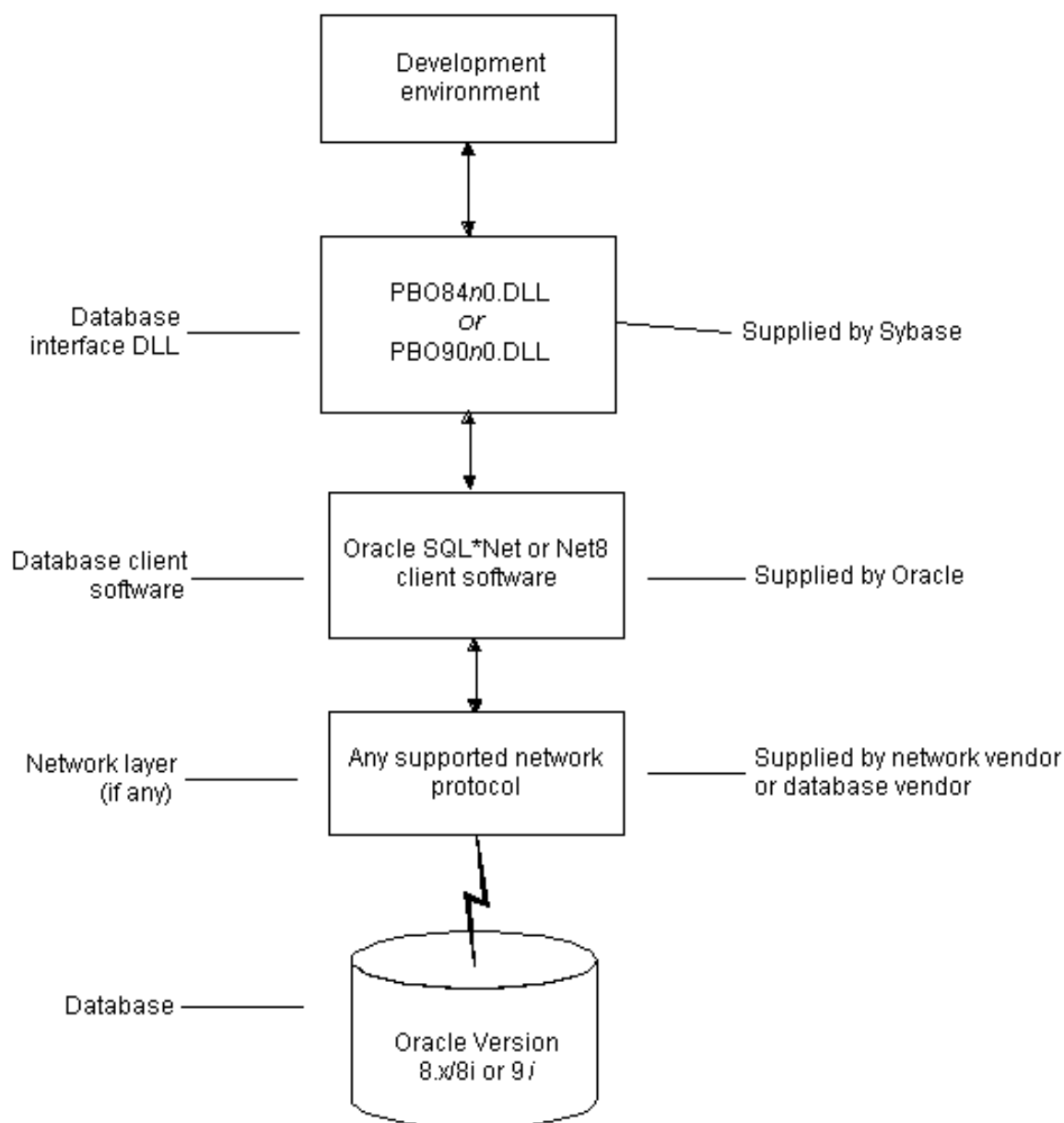

6.4.4 Preparing to use the Oracle database

Before you define the database interface and connect to an Oracle database in InfoMaker, follow these steps to prepare the database for use:

1. Install and configure the required database server, network, and client software.
2. Install the native Oracle database interface for the version of Oracle you want to access.
3. Verify that you can connect to the Oracle server and database outside InfoMaker.

Preparing an Oracle database for use with InfoMaker involves these three basic tasks.

Step 1: Install and configure the database server

You must install and configure the database server, network, and client software for Oracle.

To install and configure the database server, network, and client software:

1. Make sure the Oracle database software is installed on your computer or on the server specified in your database profile.

For example, with the Oracle O84 interface you can access an Oracle 8.0.x or Oracle8i database server.

You must obtain the database server software from Oracle Corporation.

For installation instructions, see your Oracle documentation.

2. Make sure the supported network software (such as TCP/IP) is installed and running on your computer and is properly configured so that you can connect to the Oracle database server at your site.

The Hosts and Services files must be present on your computer and properly configured for your environment.

You must obtain the network software from your network vendor or database vendor.

For installation and configuration instructions, see your network or database administrator.

3. Install the required Oracle client software on each client computer on which InfoMaker is installed.

You must obtain the client software from Oracle Corporation. Make sure the client software version you install supports all of the following:

The operating system running on the client computer

The version of the database that you want to access

The version of InfoMaker that you are running

Required client software versions

To use the Oracle 8.0.x and Oracle8i (O84) interface or the Oracle9i (O90) interface, you must install Oracle Net client software version 8.0.4 or later.

4. Make sure the Oracle SQL*Net or Net client software is properly configured so that you can connect to the Oracle database server at your site.

Installing SQL*Net software places the correct configuration file in the Oracle directory on your computer. For example, if you are using SQL*Net version 2.x, the required configuration file is called TNSNAMES.ORA.

The configuration file provides information that Oracle needs to find and connect to the database server at your site. To modify and view the information in TNSNAMES.ORA, use an Oracle tool designed to edit the configuration file (such as Oracle Network Manager or the SQL*Net Easy Configuration utility).

For information about setting up Oracle configuration files, see your SQL*Net or Net documentation.

5. If required by your operating system, make sure the directory containing the Oracle client software is in your system path.

Step 2: Install the database interface

In the InfoMaker Setup program, select the Typical install or select the Custom install and select the Oracle database interfaces you require.

For a list of the Oracle database interfaces available, see [Supported versions for Oracle](#).

Step 3: Verify the connection

Make sure you can connect to the Oracle database server and log in to the database you want to access from outside InfoMaker.

Some possible ways to verify the connection are by running the following Oracle tools:

- Accessing the database server

Tools such as Oracle TNSPING (or any other ping utility) check whether you can reach the database server from your computer.

- Accessing the database

Tools such as Oracle SQL*Plus check whether you can log in to the Oracle database you want to access and perform database operations. It is a good idea to specify the same connection parameters you plan to use in your InfoMaker database profile to access the database.

6.4.4.1 What to do next

For instructions on defining the Oracle database interface in InfoMaker, see [Defining the Oracle database interface](#).

6.4.5 Defining the Oracle database interface

To define a connection through an Oracle database interface, you must create a database profile by supplying values for at least the basic connection parameters in the Database Profile Setup dialog box for your Oracle interface. You can then select this profile at any time to connect to your database in the development environment.

For information on how to define a database profile, see [Using database profiles](#).

6.4.5.1 Specifying the Oracle server connect descriptor

To connect to an Oracle database server that resides on a network, you must specify the proper connect descriptor in the Server box on the Connection tab of the Database Profile Setup dialog box for your Oracle interface. The connect descriptor specifies the connection parameters that Oracle uses to access the database.

For help determining the proper connect descriptor for your environment, see your Oracle documentation or system administrator.

Specifying a connect descriptor

The syntax of the connect descriptor depends on the Oracle client software you are using.

If you are using Net version 8.x or later, the syntax is:

```
OracleServiceName
```

If you are using SQL*Net version 2.x, the syntax is:

```
@ TNS: OracleServiceName
```

Table 6.9:

Parameter	Description
@	The at (@) sign is required
TNS	The identifier for the Oracle Transparent Network Substrate (TNS) technology
:	The colon (:) is required
OracleServiceName	The service name assigned to your server in the Oracle configuration file for your platform

Net version 8.x example

To use Net version 8.x or later client software to connect to the service named ORA8, type the following connect descriptor in the Server box on the Connection tab of the Database Profile Setup dialog box for Oracle 8.x and later:ORA8.

6.4.6 Using Oracle stored procedures as a data source

This section describes how you can use Oracle stored procedures.

6.4.6.1 What is an Oracle stored procedure?

Oracle defines a stored procedure (or function) as a named PL/SQL program unit that logically groups a set of SQL and other PL/SQL programming language statements together to perform a specific task.

Stored procedures can take parameters and return one or more result sets (also called cursor variables). You create stored procedures in your schema and store them in the data dictionary for use by multiple users.

6.4.6.2 What you can do with Oracle stored procedures

Ways to use Oracle stored procedures

In your InfoMaker application, you can use an Oracle stored procedure as a data source for reports.

Procedures with a single result set

You can use stored procedures that return a single result set in reports, but not when using the RPCFUNC keyword to declare the stored procedure as an external function or subroutine.

6.4.6.3 Using Oracle stored procedures with result sets

Overview of basic steps

The following procedure assumes you are creating the stored procedure in the ISQL view of the Database painter in InfoMaker.

To use an Oracle stored procedure with a result set:

1. Set up the ISQL view of the Database painter to create the stored procedure.
2. Create the stored procedure with a result set as an IN OUT (reference) parameter.
3. Create reports that use the stored procedure as a data source.

Setting up the Database painter

When you create a stored procedure in the ISQL view of the Database painter, you must change the default SQL statement terminator character to one that you do not plan to use in your stored procedure syntax.

The default SQL terminator character for the Database painter is a semicolon (;). If you plan to use a semicolon in your Oracle stored procedure syntax, you must change the painter's terminator character to something other than a semicolon to avoid conflicts. A good choice is the backquote (`) character.

To change the default SQL terminator character in the Database painter:

1. Connect to your Oracle database in InfoMaker as the System user.
For instructions, see [Defining the Oracle database interface](#).
2. Open the Database painter.
3. Select Design>Options from the menu bar.
The Database Preferences property sheet displays. If necessary, click the General tab to display the General property page.
4. Type the character you want (for example, a backquote) in the SQL Terminator Character box.
5. Click Apply or OK.
The SQL Terminator Character setting is applied to the current connection and all future connections (until you change it).

Creating the stored procedure

After setting up the Database painter, you can create an Oracle stored procedure that has a result set as an IN OUT (reference) parameter. InfoMaker retrieves the result set to populate a report.

There are many ways to create stored procedures with result sets. The following procedure describes one possible method that you can use.

For information about when you can use stored procedures with single and multiple result sets, see [What you can do with Oracle stored procedures](#).

To create Oracle stored procedures with result sets:

1. Make sure your Oracle user account has the necessary database access and privileges to access Oracle objects (such as tables and procedures).

Without the appropriate access and privileges, you will be unable to create Oracle stored procedures.

2. Assume the following table `tt` exists in your Oracle database:

Table 6.10:

a	b	c
1	Newman	sysdate
2	Everett	sysdate

3. Create an Oracle package that holds the result set type and stored procedure. The result type must match your table definition.

For example, the following statement creates an Oracle package named `spm` that holds a result set type named `rctl` and a stored procedure named `proc1`. The `tt%ROWTYPE` attribute defines `rctl` to contain all of the columns in table `tt`. The procedure `proc1` takes one parameter, a cursor variable named `rc1` that is an IN OUT parameter of type `rctl`.

```
CREATE OR REPLACE PACKAGE spm
  IS TYPE rctl IS REF CURSOR
  RETURN tt%ROWTYPE;
  PROCEDURE proc1(rc1 IN OUT rctl);END;`
```

4. Create the Oracle stored procedure separately from the package you defined.

The following example shows how to create a stored procedure named `spm_proc1` that returns a single result set.

The IN OUT specification means that InfoMaker passes the cursor variable (`rc1` or `rc2`) by reference to the Oracle procedure and expects the procedure to open the cursor. After the procedure call, InfoMaker fetches the result set from the cursor and then closes the cursor.

`spm_proc1` example for reports

The following statements create `spm_proc1` that returns one result set. You can use this procedure as the data source for a report in InfoMaker.

```
CREATE OR REPLACE PROCEDURE spm_proc1(rc1 IN OUT spm.rctl)
AS
BEGIN
  OPEN rc1 FOR SELECT * FROM tt;END;
```

Error checking

If necessary, check the Oracle system table `public.user_errors` for a list of errors.

Creating the report

After you create the stored procedure, you can define the report that uses the stored procedure as a data source.

You can use Oracle stored procedures that return a single result set in a report.

The following procedure assumes that your Oracle stored procedure returns only a single result set.

To create a report using an Oracle stored procedure with a result set:

1. Select a presentation style on the DataWindow page of the New dialog box and click OK.
2. Select the Stored Procedure icon and click OK.

The Select Stored Procedure wizard page displays, listing the stored procedures available in your database.

3. Select the stored procedure you want to use as a data source, and click Next.
4. Complete the wizard to define the report.

When you preview the report, InfoMaker fetches the result set from the cursor in order to populate the report. If you selected Retrieve on Preview on the Choose Data Source page in the wizard, the result set displays in the Preview view when the DataWindow opens.

For more instructions on defining reports, see the User's Guide.

6.4.6.4 Using a large-object output parameter

You can define a large object (LOB) as an output parameter for an Oracle stored procedure or function to retrieve large-object data. There is no limit on the number of LOB output arguments that might be defined for each stored procedure or function.

6.4.7 Using Oracle user-defined types

What InfoMaker supports

When you use the O84 and O90 database interfaces, InfoMaker supports SQL CREATE TYPE and CREATE TABLE statements for Oracle user-defined types (objects) in the ISQL view of the Database painter. It correctly handles SQL SELECT, INSERT, UPDATE, and DELETE statements for user-defined types in the Database and Report painters.

What you can do

This means that using these database interfaces in InfoMaker, you can:

Table 6.11:

Do this	In
Use Oracle syntax to create user-defined types	Database painter
Use Oracle syntax to create tables with columns that reference user-defined types	Database painter
View columns in Oracle tables that reference user-defined types	Database painter

Do this	In
Manipulate data in Oracle tables that have user-defined types	Database painter Report painter Reports
Export Oracle table syntax containing user-defined types to a log file	Database painter
Invoke methods of objects columns	Report painter (Compute tab in SQL Toolbox)

Example

Here is a simple example that shows how you might create and use Oracle 8 user-defined types in InfoMaker.

For more information about Oracle user-defined types, see your Oracle 8 documentation.

To create and use Oracle 8 and later user-defined types:

1. In the ISQL view of the Database painter, create two Oracle user-defined types: `ball_stats_type` and `player_type`.

Here is the Oracle syntax to create `ball_stats_type`. Notice that the `ball_stats` object of type `ball_stats_type` has a method associated with it called `get_avg`.

```
CREATE OR REPLACE TYPE ball_stats_type AS OBJECT (bat_avg NUMBER(4,3), rbi
NUMBER(3), MEMBER FUNCTION get_avg RETURN NUMBER, PRAGMA RESTRICT_REFERENCES
(get_avg, WNDS, RNPS, WNPS));
CREATE OR REPLACE TYPE BODY ball_stats_type AS MEMBER FUNCTION get_avg RETURN
NUMBER ISBEGINRETURN SELF.bat_avg;
END;
END;
```

Here is the Oracle SQL syntax to create `player_type`. `Player_type` references the user-defined type `ball_stats_type`. InfoMaker supports such nesting graphically in the Database, Report, and Table painters (see step 3).

```
CREATE TYPE player_type AS OBJECT (player_no NUMBER(2), player_name
VARCHAR2(30), ball_stats ball_stats_type);
```

2. In the Database painter, create an Oracle 8 table named `lineup` that references these user-defined types.

Here is the Oracle SQL syntax to create the `lineup` table and insert a row. `Lineup` references the `player_type` user-defined type.

```
CREATE TABLE lineup (position NUMBER(2) NOT NULL, player player_type);
INSERT INTO lineup VALUES (1, player_type (5, 'Manny Ramirez', ball_stats_type
(0.342, 46)));
```

3. Display the `lineup` table in the Database or Report painter.

InfoMaker uses the following structure->member notation to display the table:

```
lineup
=====
```

```

position
player->player_no
player->player_name
player->ball_stats->bat_avg
player->ball_stats->rbi

```

- To access the `get_avg` method of the object `ball_stats` contained in the object column `player`, use the following structure->member notation when defining a computed column for the report. For example, when working in the Report painter, you could use this notation on the Compute tab in the SQL Toolbox:

```

player->ball_stats->get_avg()

```

6.4.8 What to do next

For instructions on connecting to the database, see [Connecting to a database](#).

6.5 Adaptive Server Enterprise

This section describes how to use the Adaptive Server Enterprise database interface in InfoMaker.

Client Library API

The Adaptive Server database interface uses the Open Client CT-Library (CT-Lib) application programming interface (API) to access the database.

When you connect to an Adaptive Server database, InfoMaker makes the required calls to the API. Therefore, you do not need to know anything about CT-Lib to use the database interface.

6.5.1 Supported versions for Adaptive Server

You can access Adaptive Server versions 15.x and 16.x using the Adaptive Server database interface. Use of this interface to access other Open Server programs is not supported.

The Adaptive Server database interface uses a DLL named `PBSYC190.dll` to access the database through the Open Client CT-Lib API.

6.5.2 Supported Adaptive Server datatypes

The Adaptive Server interface supports the SAP datatypes listed in the following table in reports.

Table 6.12: Supported datatypes for Adaptive Server Enterprise

Binary	Numeric
Bit	NVarChar (ASE 12.5 only)
Char (see Column-length limits)	Real
DateTime	SmallDateTime
Decimal	SmallInt
Double precision	SmallMoney

Float	Text
Identity	Timestamp
Image	TinyInt
Int	VarBinary
Money	VarChar
NChar (ASE 12.5 only)	BigTime (ASE 15.5 or later)
BigDateTime (ASE 15.5 or later)	

Accessing Unicode data

InfoMaker can connect, save, and retrieve data in both ANSI/DBCS and Unicode databases. When character data or command text is sent to the database, InfoMaker sends a DBCS string if the UTF8 database parameter is set to 0 (the default). If UTF8 is set to 1, InfoMaker sends a UTF-8 string.

The database server must be configured correctly to accept UTF-8 strings. See the description of the UTF-8 database parameter in the online Help for more information.

A Unicode database is a database whose character set is set to a Unicode format, such as UTF-8, UTF-16, UCS-2, or UCS-4. All data must be in Unicode format, and any data saved to the database must be converted to Unicode data implicitly or explicitly.

A database that uses ANSI (or DBCS) as its character set might use special datatypes to store Unicode data. These datatypes are NCHAR, NVARCHAR, and NVARCHAR2. Columns with this datatype can store only Unicode data. Any data saved into such a column must be converted to Unicode explicitly. This conversion must be handled by the database server or client.

Column-length limits

Adaptive Server 12.0 and earlier have a column-length limit of 255 bytes. Adaptive Server 12.5.x supports wider columns for Char, VarChar, Binary, and VarBinary datatypes, depending on the logical page size and the locking scheme used by the server.

In InfoMaker, you can use these wider columns for Char and VarChar datatypes with Adaptive Server 12.5.x when the following conditions apply:

- The Release database parameter is set to 12.5 or 12.5.1.
- You are accessing the database using Open Client 12.5.x.

The database must be configured to use a larger page size to take full advantage of the widest limits.

For detailed information about wide columns and configuration issues, see the Adaptive Server 12.5.x documentation on the SAP web site. For more information about the Release database parameter, see the online Help.

6.5.3 Basic software components for Adaptive Server

You must install the software components in the following figure to access an Adaptive Server database in InfoMaker.

Figure: Components of an Adaptive Server Enterprise connection

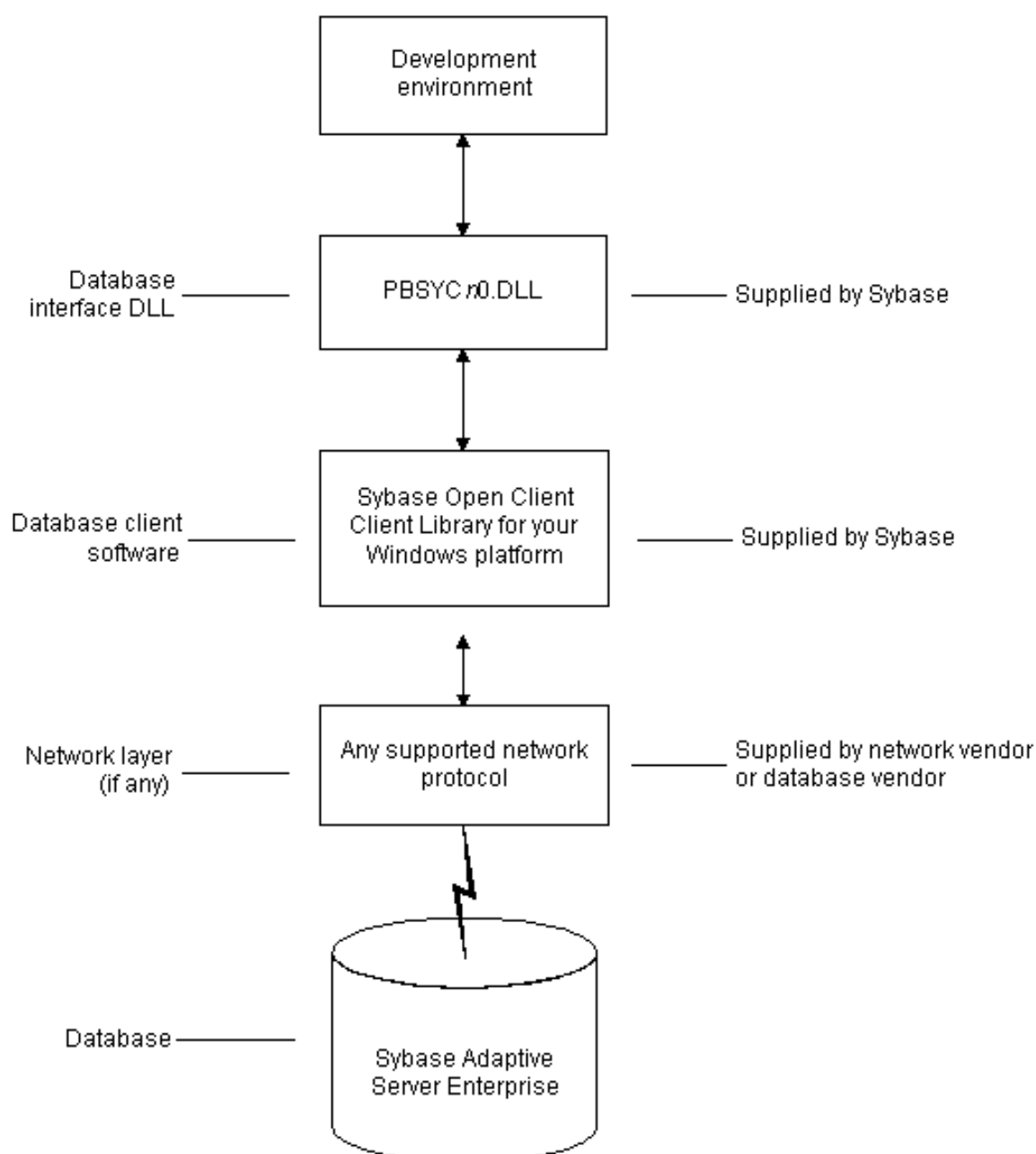

6.5.4 Preparing to use the Adaptive Server database

Before you define the interface and connect to an Adaptive Server database in InfoMaker, follow these steps to prepare the database for use:

1. Install and configure the required database server, network, and client software.
2. Install the Adaptive Server database interface.
3. Verify that you can connect to Adaptive Server outside InfoMaker.
4. Install the required InfoMaker stored procedures in the sybssystemprocs database.

Preparing an Adaptive Server database for use with InfoMaker involves these four basic tasks.

Step 1: Install and configure the database server

You must install and configure the database server, network, and client software for Adaptive Server.

To install and configure the database server, network, and client software:

1. Make sure the Adaptive Server database software is installed on the server specified in your database profile.

You must obtain the database server software from SAP.

For installation instructions, see your Adaptive Server documentation.

2. Make sure the supported network software (for example, TCP/IP) is installed and running on your computer and is properly configured so that you can connect to the database server at your site.

You must install the network communication driver that supports the network protocol and operating system platform you are using. The driver is installed as part of the Net-Library client software.

For installation and configuration instructions, see your network or database administrator.

3. Install the required Open Client CT-Library (CT-Lib) software on each client computer on which InfoMaker is installed.

You must obtain the Open Client software from SAP. Make sure the version of Open Client you install supports all of the following:

The operating system running on the client computer

The version of Adaptive Server that you want to access

The version of InfoMaker that you are running

Required client software versions

To use the SYC Adaptive Server interface, you must install Open Client version 10.0.4 or later.

4. Make sure the Open Client software is properly configured so that you can connect to the database at your site.

Installing the Open Client software places the SQL.INI configuration file in the Adaptive Server directory on your computer.

SQL.INI provides information that Adaptive Server needs to find and connect to the database server at your site. You can enter and modify information in SQL.INI by using the configuration utility that comes with the Open Client software.

For information about setting up the SQL.INI or other required configuration file, see your Adaptive Server documentation.

5. If required by your operating system, make sure the directory containing the Open Client software is in your system path.
6. Make sure only one copy of each of the following files is installed on your client computer:
 - Adaptive Server interface DLL
 - Network communication DLL (for example, NLWNSCK.DLL for Windows Sockets-compliant TCP/IP)
 - Database vendor DLL (for example, LIBCT.DLL)

Step 2: Install the database interface

In the InfoMaker Setup program, select the Typical install, or select the Custom install and select the Adaptive Server Enterprise (SYC) database interface.

Step 3: Verify the connection

Make sure you can connect to the Adaptive Server database server and log in to the database you want to access from outside InfoMaker.

Some possible ways to verify the connection are by running the following tools:

- Accessing the database server
Tools such as the Open Client/Open Server Configuration utility (or any Ping utility) check whether you can reach the database server from your computer.
- Accessing the database
Tools such as ISQL (interactive SQL utility) check whether you can log in to the database and perform database operations. It is a good idea to specify the same connection parameters you plan to use in your InfoMaker database profile to access the database.

Step 4: Install the InfoMaker stored procedures

InfoMaker requires you to install certain stored procedures in the sybssystemprocs database before you connect to an Adaptive Server database for the first time. InfoMaker uses these stored procedures to get information about tables and columns from the DBMS system catalog.

Run the SQL script or scripts required to install the InfoMaker stored procedures in the sybssystemprocs database.

For instructions, see [Installing InfoMaker stored procedures in Adaptive Server databases](#).

6.5.4.1 What to do next

For instructions on defining the Adaptive Server database interface in InfoMaker, see [Defining the Adaptive Server database interface](#).

6.5.5 Defining the Adaptive Server database interface

To define a connection through the Adaptive Server interface, you must create a database profile by supplying values for at least the basic connection parameters in the Database

Profile Setup - Adaptive Server Enterprise dialog box. You can then select this profile anytime to connect to your database in the development environment.

For information on how to define a database profile, see [Using database profiles](#).

6.5.6 Using Open Client security services

The Adaptive Server interface provides several DBParm parameters that support Open Client 11.1.x or later network-based security services in your application. If you are using the required database, security, and InfoMaker software, you can build applications that take advantage of Open Client security services.

6.5.6.1 What are Open Client security services?

Open Client 11.1.x or later security services allow you to use a supported third-party security mechanism (such as CyberSafe Kerberos) to provide login authentication and per-packet security for your application. Login authentication establishes a secure connection, and per-packet security protects the data you transmit across the network.

6.5.6.2 Requirements for using Open Client security services

To use Open Client security services in your application, all of the following must be true:

- Accessing Adaptive Server through Open Client 11.1.1x or later

You are accessing an Adaptive Server database server using Open Client Client-Library (CT-Lib) 11.x or later software

- Have network security mechanism and driver

You have the required SAP-supported network security mechanism and SAP-supplied security driver properly installed and configured for your environment. Depending on your operating system platform, examples of supported security mechanisms include: Distributed Computing Environment (DCE) security servers and clients, CyberSafe Kerberos, and Windows NT LAN Manager Security Services Provider Interface (SSPI).

For information about the third-party security mechanisms and operating system platforms that Apeon has tested with Open Client security services, see the Open Client documentation.

- Can access the secure server outside InfoMaker

You must be able to access a secure Adaptive Server server using Open Client 11.1.x or later software from outside InfoMaker.

To verify the connection, use a tool such as ISQL or SQL Advantage to make sure you can connect to the server and log in to the database with the same connection parameters and security options you plan to use in your InfoMaker application.

- Using database interface

You are using the SYC Adaptive Server interface to access the database.

- Release DBParm parameter set to the appropriate value for your database

You have set the Release DBParm parameter to 11, 11.5, 12, 12.5, or 12.5.1 to specify that your application should use the appropriate version of the Open Client CT-Lib software.

For instructions, see Release in the online Help.

- Security mechanism and driver support requested service

The security mechanism and driver you are using must support the service requested by the DBParm parameter.

6.5.6.3 Security services DBParm parameters

If you have met the requirements described in [Requirements for using Open Client security services](#), you can set the security services DBParm parameters in the Database Profile Setup dialog box for your connection.

There are two types of DBParm parameters that you can set to support Open Client security services: login authentication and per-packet security.

Login authentication DBParms

The following login authentication DBParm parameters correspond to Open Client 11.1.x or later connection properties that allow an application to establish a secure connection.

Sec_Channel_Bind

Sec_Cred_Timeout

Sec_Delegation

Sec_Keytab_File

Sec_Mechanism

Sec_Mutual_Auth

Sec_Network_Auth

Sec_Server_Principal

Sec_Sess_Timeout

For instructions on setting these DBParm parameters, see their descriptions in online Help.

Per-packet security DBParms

The following per-packet security DBParm parameters correspond to Open Client 11.1.x or later connection properties that protect each packet of data transmitted across a network. Using per-packet security services might create extra overhead for communications between the client and server.

Sec_Confidential

Sec_Data_Integrity

Sec_Data_Origin

Sec_Replay_Detection

Sec_Seq_Detection

For instructions on setting these DBParm parameters, see their descriptions in online Help.

6.5.7 Using Open Client directory services

The Adaptive Server interface provides several DBParm parameters that support Open Client 11.1.x or later network-based directory services in your application. If you are using the required database, directory services, and InfoMaker software, you can build applications that take advantage of Open Client directory services.

6.5.7.1 What are Open Client directory services?

Open Client 11.1.x or later directory services allow you to use a supported third-party directory services product (such as the Windows NT Registry) as your directory service provider. Directory services provide centralized control and administration of the network entities (such as users, servers, and printers) in your environment.

6.5.7.2 Requirements for using Open Client directory services

To use Open Client directory services in your application, all of the following must be true:

- You are accessing an Adaptive Server database server using Open Client Client-Library (CT-Lib) 11.x or later software
- You have the required SAP-supported directory service provider software and SAP-supplied directory driver properly installed and configured for your environment. Depending on your operating system platform, examples of supported security mechanisms include: the Windows NT Registry, Distributed Computing Environment Cell Directory Services (DCE/CDS), Banyan StreetTalk Directory Assistance (STDA), and Novell NetWare Directory Services (NDS).

For information about the directory service providers and operating system platforms that Apeon has tested with Open Client directory services, see the Open Client documentation.

- You must be able to access a secure Adaptive Server server using Open Client 11.1.x or later software from outside InfoMaker.

To verify the connection, use a tool such as ISQL or SQL Advantage to make sure you can connect to the server and log in to the database with the same connection parameters and directory service options you plan to use in your InfoMaker application.

- You are using the SYC Adaptive Server interface to access the database.
- You must use the correct syntax as required by your directory service provider when specifying the server name in a database profile. Different providers require different syntax based on their format for specifying directory entry names.

For information and examples for different directory service providers, see [Specifying the server name with Open Client directory services](#).

- You have set the Release DBParm parameter to 11, 11.5, 12, 12.5, or 12.5.1 to specify that your application should use the behavior of the appropriate version of the Open Client CT-Lib software.

For instructions, see Release (Adaptive Server Enterprise) in the online Help.

- The directory service provider and driver you are using must support the service requested by the DBParm parameter.

6.5.7.3 Specifying the server name with Open Client directory services

When you are using Open Client directory services in a InfoMaker application, you must use the syntax required by your directory service provider when specifying the server name in a database profile to access the database.

Different directory service providers require different syntax based on the format they use for specifying directory entry names. Directory entry names can be fully qualified or relative to the default (active) Directory Information Tree base (DIT base) specified in the Open Client/Server configuration utility.

The DIT base is the starting node for directory searches. Specifying a DIT base is analogous to setting a current working directory for UNIX or MS-DOS file systems. (You can specify a nondefault DIT base with the DS_DitBase DBParm parameter. For information, see DS_DitBase in the online Help.)

Windows NT Registry server name example

This example shows typical server name syntax if your directory service provider is the Windows NT Registry.

```
Node name: SALES:software\sybase\server\SYS12NTDIT base: SALES:software\sybase
\serverServer name: SYS12NT
```

To specify the server name in a database profile:

- Type the following in the Server box on the Connection tab in the Database Profile Setup dialog box. Do not start the server name with a backslash (\).

```
SYS12NT
```

DCE/DCS server name example

This example shows typical server name syntax if your directory service provider is Distributed Computing Environment Cell Directory Services (DCE/CDS).

```
Node name: ../../boston.sales/dataservers/sybase/SYS12DIT base: ../../boston.sales/
dataserversServer name: sybase/SYS12
```

To specify the server name in a database profile:

- Type the following in the Server box on the Connection tab in the Database Profile Setup dialog box. Do not start the server name with a slash (/).

```
sybase/SYS12
```

Banyan STDA server name example

This example shows typical server name syntax if your directory service provider is Banyan StreetTalk Directory Assistance (STDA).

```
Node name: SYS12@sales@chicagoDIT base: chicagoServer name: SYS12@sales
```

To specify the server name in a database profile:

- Type the following in the Server box on the Connection tab in the Database Profile Setup dialog box. Do not end the server name with @.

```
SYS12@sales
```

Novell NDS server name example

This example shows typical server name syntax if your directory service provider is Novell NetWare Directory Services (NDS).

```
Node name: CN=SYS12.OU=miami.OU=sales.O=sybaseDIT base:  
OU=miami.OU=sales.O=sybaseServer name: SYS12
```

To specify the server name in a database profile:

- Type the following in the Server box on the Connection tab in the Database Profile Setup dialog box. Do not start the server name with CN=.

```
SYS12
```

6.5.7.4 Directory services DBParm parameters

If you have met the requirements described in [Requirements for using Open Client directory services](#), you can set the directory services DBParm parameters in a database profile for your connection.

The following DBParm parameters correspond to Open Client 11.1.x or later directory services connection parameters:

DS_Alias

DS_Copy

DS_DitBase

DS_Failover

DS_Password (Open Client 12.5 or later)

DS_Principal

DS_Provider

DS_TimeLimit

For instructions on setting these DBParm parameters, see their descriptions in the online Help.

6.5.8 Using PRINT statements in Adaptive Server stored procedures

The SYC Adaptive Server database interface allows you to use PRINT statements in your stored procedures for debugging purposes.

This means, for example, that if you turn on Database Trace when accessing the database through the SYC interface, PRINT messages appear in the trace log but they do not return errors or cancel the rest of the stored procedure.

6.5.9 Creating a DataWindow based on a heterogeneous cross-database join

This functionality is available through the use of Adaptive Server's Component Integration Services. Component Integration Services allows you to connect to multiple remote

heterogeneous database servers and define multiple proxy tables that reference the tables residing on those servers.

For information on how to create proxy tables, see the Adaptive Server documentation.

6.5.10 What to do next

For instructions on connecting to the database, see [Connecting to a database](#).

6.6 Installing InfoMaker stored procedures in Adaptive Server databases

This section describes how to install InfoMaker stored procedures in an Adaptive Server database by running SQL scripts provided for this purpose.

Apeon recommends that you run these scripts outside InfoMaker before connecting to an Adaptive Server database for the first time through the Adaptive Server (SYC DBMS identifier) native database interface. Although the PBSYC development environment will run without the InfoMaker stored procedures created by these scripts, the stored procedures are required for full functionality.

6.6.1 What are the InfoMaker stored procedure scripts?

What you do

In order to work with an Adaptive Server database in InfoMaker, you or your system administrator should install certain stored procedures in the database before you connect to Adaptive Server from InfoMaker for the first time.

You must run the InfoMaker stored procedure scripts only once per database server, and not before each InfoMaker session. If you have already installed the InfoMaker stored procedures in your Adaptive Server database before connecting in InfoMaker on any supported platform, you need not install the stored procedures again before connecting in InfoMaker on a different platform.

InfoMaker stored procedures

A stored procedure is a group of precompiled and preoptimized SQL statements that performs some database operation. Stored procedures reside on the database server where they can be accessed as needed.

InfoMaker uses these stored procedures to get information about tables and columns from the Adaptive Server system catalog. (The InfoMaker stored procedures are different from the stored procedures you might create in your database.)

SQL scripts

InfoMaker provides SQL script files for installing the required stored procedures in sybssystemprocs database:

Table 6.13:

Script	Use for
PBSYC.SQL	Adaptive Server databases

Script	Use for
PBSYC2.SQL	Adaptive Server databases to restrict the Select Tables list

Where to find the scripts

The stored procedure scripts are located in the Server directory on the InfoMaker installation package. The Server directory contains server-side installation components that are not installed with InfoMaker on your computer.

6.6.1.1 PBSYC.SQL script

What it does

The PBSYC.SQL script contains SQL code that overwrites stored procedures that correspond to the same version of InfoMaker in the Adaptive Server sybssystemprocs database and then re-creates them.

The PBSYC.SQL script uses the sybssystemprocs database to hold the InfoMaker stored procedures. This database is created when you install Adaptive Server.

When to run it

Before you connect to an Adaptive Server database in InfoMaker for the first time using the SYC DBMS identifier, you or your database administrator must run the PBSYC.SQL script once per database server into the sybssystemprocs database.

Run PBSYC.SQL if the server at your site will be accessed by anyone using the InfoMaker development environment or by deployment machines.

If you or your database administrator have already run the current version of PBSYC.SQL to install InfoMaker stored procedures in the sybssystemprocs database on your server, you need not rerun the script to install the stored procedures again.

For instructions on running PBSYC.SQL, see [How to run the scripts](#).

Stored procedures it creates

The PBSYC.SQL script creates the following InfoMaker stored procedures in the Adaptive Server sybssystemprocs database. The procedures are listed in the order in which the script creates them.

Table 6.14:

PBSYC.SQL procedure	What it does
sp_pb100column	Lists the columns in a table.
sp_pb100pkcheck	Determines whether a table has a primary key.
sp_pb100fktable	Lists the tables that reference the current table.
sp_pb100procdesc	Retrieves a description of the argument list for a specified stored procedure.
sp_pb100proclist	Lists available stored procedures and extended stored procedures. If the SystemProcs DBParm parameter is set to 1 or Yes (the default), sp_pb100proclist displays both system stored procedures and

PBSYC.SQL s procedure	What it does
	user-defined stored procedures. If SystemProcs is set to 0 or No, sp_pb100proclist displays only user-defined stored procedures.
sp_pb100text	Retrieves the text of a stored procedure from the SYSCOMMENTS table.
sp_pb100table	Retrieves information about all tables in a database, including those for which the current user has no permissions. PBSYC.SQL contains the default version of sp_pb100table. If you want to replace the default version of sp_pb100table with a version that restricts the table list to those tables for which the user has SELECT permission, you can run the PBSYC2.SQL script, described in PBSYC2.SQL script .
sp_pb100index	Retrieves information about all indexes for a specified table.

6.6.1.2 PBSYC2.SQL script

What it does

The PBSYC2.SQL script contains SQL code that drops and re-creates one InfoMaker stored procedure in the Adaptive Server sybserverprocs database: a replacement version of sp_pb100table.

The default version of sp_pb100table is installed by the PBSYC.SQL script. InfoMaker uses the sp_pb100table procedure to build a list of all tables in the database, including those for which the current user has no permissions. This list displays in the Select Tables dialog box in InfoMaker.

For security reasons, you or your database administrator might want to restrict the table list to display only those tables for which a user has permissions. To do this, you can run the PBSYC2.SQL script after you run PBSYC.SQL. PBSYC2.SQL replaces the default version of sp_pb100table with a new version that displays a restricted table list including only tables and views:

- Owned by the current user
- For which the current user has SELECT authority
- For which the current user's group has SELECT authority
- For which SELECT authority was granted to PUBLIC

When to run it

If you are accessing an Adaptive Server database using the SYC DBMS identifier in InfoMaker, you must first run PBSYC.SQL once per database server to install the required InfoMaker stored procedures in the sybserverprocs database.

After you run PBSYC.SQL, you can optionally run PBSYC2.SQL if you want to replace sp_pb100table with a version that restricts the table list to those tables for which the user has SELECT permission.

If you do not want to restrict the table list, there is no need to run PBSYC2.SQL.

For instructions on running PBSYC2.SQL, see [How to run the scripts](#).

Stored procedure it creates

The PBSYC2.SQL script creates the following InfoMaker stored procedure in the Adaptive Server sybsystemprocs database:

Table 6.15:

PBSYC2.SQL procedure	What it does
sp_pb100table	Retrieves information about those tables in the database for which the current user has SELECT permission. This version of sp_pb100table replaces the default version of sp_pb100table installed by the PBSYC.SQL script.

6.6.2 How to run the scripts

You can use the ISQL or SQL Advantage tools to run the stored procedure scripts outside InfoMaker.

6.6.2.1 Using ISQL to run the stored procedure scripts

ISQL is an interactive SQL utility that comes with the Open Client software on the Windows platforms. If you have ISQL installed, use the following procedure to run the InfoMaker stored procedure scripts.

For complete instructions on using ISQL, see your Open Client documentation.

To use ISQL to run the InfoMaker stored procedure scripts:

1. Connect to the sybsystemprocs Adaptive Server database as the system administrator.
2. Open one of the following files containing the InfoMaker stored procedure script you want to run:

PBSYC.SQL

PBSYC2.SQL

3. Issue the appropriate ISQL command to run the SQL script with the user ID, server name, and (optionally) password you specify. Make sure you specify uppercase and lowercase exactly as shown:

```
isql /U sa /S SERVERNAME /i pathname /P { password }
```

Table 6.16:

Parameter	Description
sa	The user ID for the system administrator. Do not change this user ID.
SERVERNAME	The name of the computer running the Adaptive Server database.
pathname	The drive and directory containing the SQL script you want to run.

Parameter	Description
password	(Optional) The password for the sa (system administrator) user ID. The default Adaptive Server installation creates the sa user ID without a password. If you changed the password for sa during the installation, replace password with your new password.

For example, if you are using InfoMaker and are accessing the stored procedure scripts from d:\server\, type either of the following:

```
isql /U sa /S TESTDB /i d:\server\pbsyb.sql /P
isql /U sa /S SALES /i d:\server\pbsyc.sql /P adminpwd
```

6.6.2.2 Using SQL Advantage to run the stored procedure scripts

SQL Advantage is an interactive SQL utility that comes with the Open Client software on the Windows platform. If you have SQL Advantage installed, use the following procedure to run the InfoMaker stored procedure scripts.

For complete instructions on using SQL Advantage, see your Open Client documentation.

To use SQL Advantage to run the InfoMaker stored procedure scripts:

1. Start the SQL Advantage utility.
2. Open a connection to the sybsystemprocs Adaptive Server database as the system administrator.
3. Open one of the following files containing the InfoMaker stored procedure script you want to run:

PBSYC.SQL

PBSYC2.SQL

4. Delete the use sybsystemprocs command and the go command at the beginning of each script.

SQL Advantage requires that you issue the use sybsystemprocs command by itself, with no other SQL commands following it. When you open a connection to the sybsystemprocs database in step 2, you are in effect issuing the use sybsystemprocs command. This command should not be issued again as part of the stored procedure script.

Therefore, to successfully install the stored procedures, you must delete the lines shown in the following table from the beginning of the InfoMaker stored procedure script before executing the script.

Table 6.17:

Before executing this script	Delete these lines
PBSYC.SQL	use sybsystemprocs go

Before executing this script	Delete these lines
PBSYC2.SQL	use sybsemproc go

5. Execute all of the statements in the SQL script.
6. Exit the SQL Advantage session.

6.7 DirectConnect

This section describes how to use the DirectConnect interface in InfoMaker.

6.7.1 Using the DirectConnect interface

The DirectConnect interface uses SAP Sybase's Open Client CT-Library (CT-Lib) API to access a database through SAP Sybase middleware data access products such as the DirectConnect for OS/390 component of MainFrame Connect and Open ServerConnect.

Accessing Unicode data

InfoMaker can connect, save, and retrieve data in both ANSI/DBCS and Unicode databases. When character data or command text is sent to the database, InfoMaker sends a DBCS string if the UTF8 database parameter is set to 0 (the default). If UTF8 is set to 1, InfoMaker sends a UTF-8 string.

The database server must have the UTF-8 character set installed. See the description of the UTF-8 database parameter in the online Help for more information.

A Unicode database is a database whose character set is set to a Unicode format, such as UTF-8, UTF-16, UCS-2, or UCS-4. All data must be in Unicode format, and any data saved to the database must be converted to Unicode data implicitly or explicitly.

A database that uses ANSI (or DBCS) as its character set might use special datatypes to store Unicode data. These datatypes are NCHAR, NVARCHAR, and NVARCHAR2. Columns with this datatype can store only Unicode data. Any data saved into such a column must be converted to Unicode explicitly. This conversion must be handled by the database server or client.

6.7.1.1 Connecting through the DirectConnect middleware product

SAP Sybase DirectConnect is a data access server that provides a standardized middleware interface between your applications and your enterprise data sources. Data access services to a particular database are defined in a DirectConnect server. Since a DirectConnect server can support multiple access services, you can access multiple databases through a single server.

When you use the DirectConnect interface to connect to a particular database, your connection is routed through the access service for that database. An access service consists of a named set of configuration properties and a specific access service library.

To access DB2 data on an IBM mainframe through a DirectConnect server, you can use the DirectConnect interface to connect through either a DirectConnect for MVS access service or a DirectConnect Transaction Router Service (TRS).

TRS provides fast access to a DB2/MVS database by using remote stored procedures. The DirectConnect interface supports both versions of the TRS library: TRSLU62 and TRSTCP.

The DirectConnect server operates in two modes: SQL transformation and passthrough. The DirectConnect interface for DB2/MVS uses passthrough mode, which allows your InfoMaker application to have direct access to the capabilities of the DB2/MVS data source.

6.7.1.2 Connecting through the Open ServerConnect middleware product

SAP Sybase's Open ServerConnect supports mainframe applications that retrieve and update data stored on the mainframe that SAP Sybase client applications can execute. Client applications can connect directly to a DB2/MVS database through an Open ServerConnect application residing on the mainframe, eliminating the need for an intermediate gateway like DirectConnect. (This type of connection is also known as a gateway-less connection.) In addition, an Open ServerConnect application presents mainframe Remote Procedure Calls (RPCs) as database stored procedures to the client application.

To access DB2 data on an IBM mainframe through Open ServerConnect, you can use the DirectConnect interface to connect through Open ServerConnect for IMS and MVS.

6.7.1.3 Selecting the type of connection

To select how InfoMaker accesses the database, use the Choose Gateway drop-down list on the Connection tab of the DirectConnect Database Profile Setup dialog box and select one of the following:

- Access Service
- Gatewayless
- TRS

All the DBParm parameters defined for the DirectConnect interface are applicable to all three connections except the following:

- HostReqOwner applies to Access Service and Gatewayless only
- Request, ShowWarnings, and SystemOwner apply to Access Service only
- UseProcSyntax applies to Gatewayless only

See the online help for the complete list of DBParm parameters applicable to the DirectConnect interface.

6.7.2 Basic software components for the DirectConnect interface

The following figure shows the basic software components required to access a database using the DirectConnect interface and the DirectConnect middleware data access product.

Figure: Components of a DirectConnect connection using DirectConnect middleware

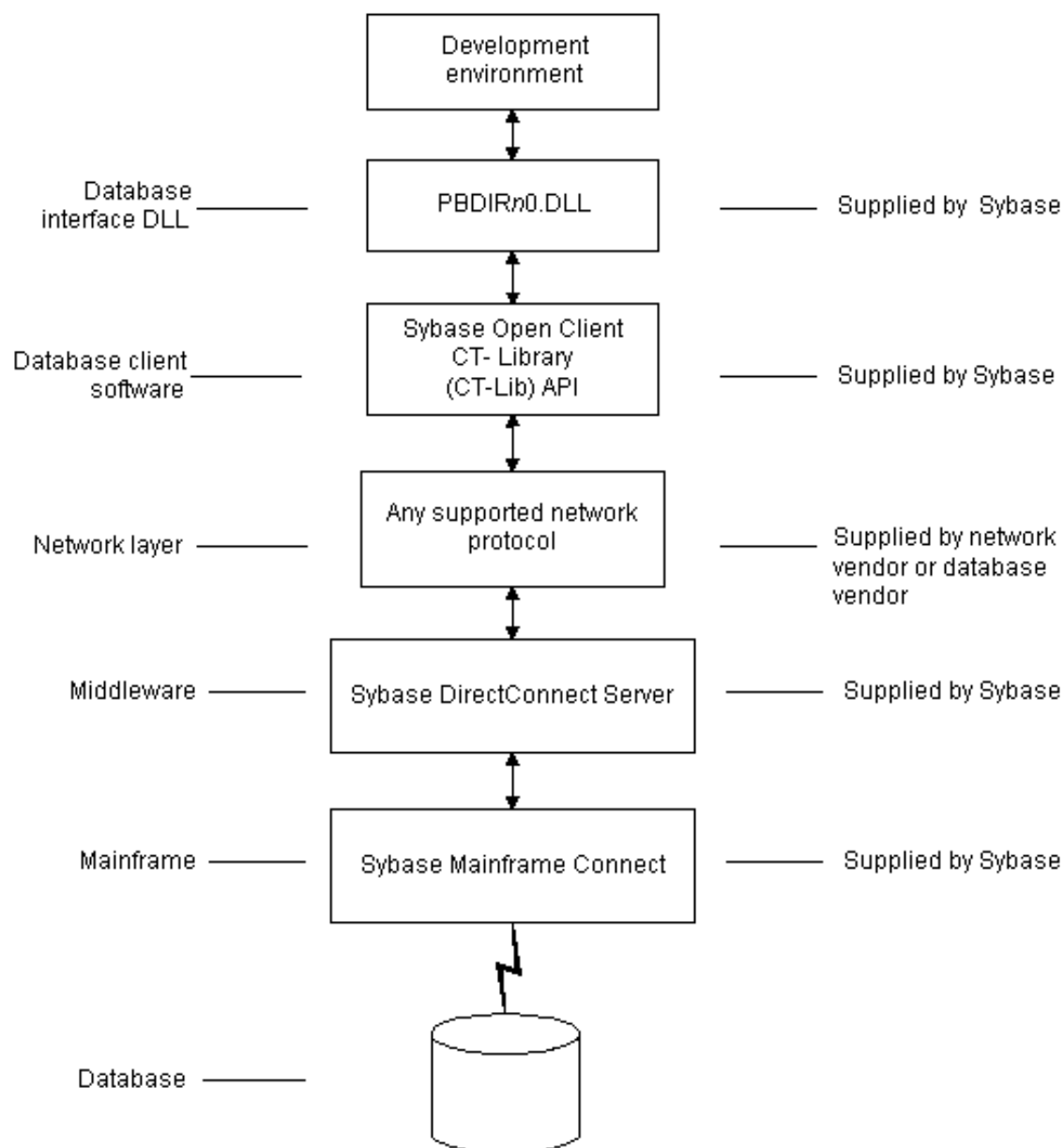

The following figure shows the basic software components required to access a database using the DirectConnect interface and the Open ServerConnect middleware data access product.

Figure: Components of a DirectConnect connection using Open ServerConnect middleware

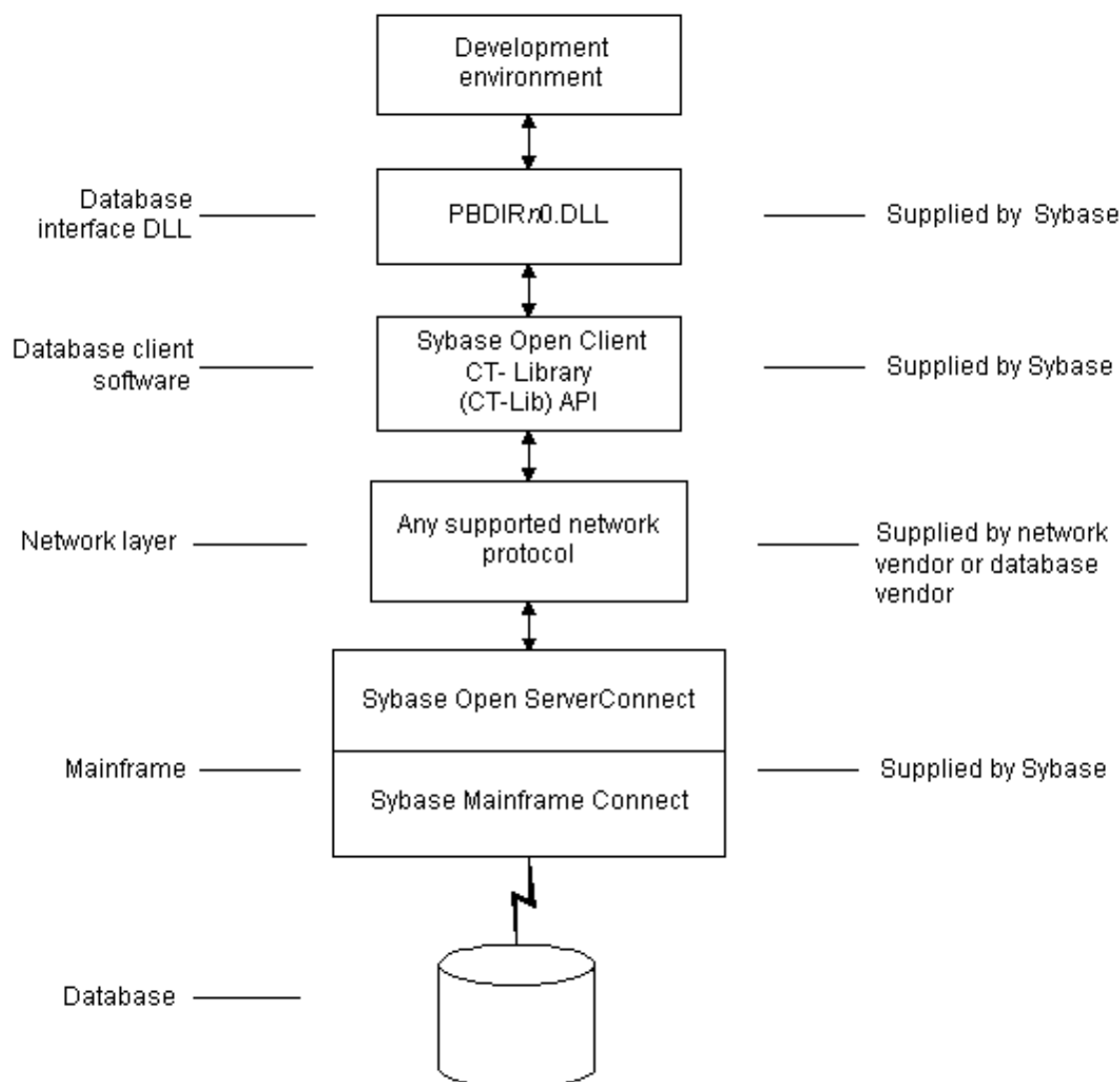

6.7.3 Supported versions for the DirectConnect interface

The DirectConnect interface uses a DLL named PBDIR190.dll to access a database through either DirectConnect or Open ServerConnect.

Required DirectConnect versions

To access a DB2/MVS database through the access service, it is strongly recommended that you use DirectConnect for MVS access service version 11.1.1p4 or later.

To access a DB2/MVS database through TRS, it is strongly recommended that you use DirectConnect TRS version 11.1.1p4 or later.

For information on DirectConnect for MVS and TRS, see your DirectConnect documentation.

Required Open ServerConnect versions

To access a DB2/MVS database through Open ServerConnect, it is strongly recommended that you use Open ServerConnect IMS and MVS version 4.0 or later.

For information on Open ServerConnect for MVS, see your Open ServerConnect documentation.

6.7.4 Supported DirectConnect interface datatypes

The DirectConnect interface supports the InfoMaker datatypes listed in the following table in reports.

Table 6.18: Supported datatypes for DirectConnect

Char (fewer than 255 characters)	Long VarChar
Char for Bit Data	Real
Date	SmallInt
Decimal	Time
Double Precision	Timestamp (DateTime)
Float	VarChar
Integer	VarChar for Bit Data

6.7.5 Preparing to use the database with DirectConnect

Before you define the interface and connect to a database through the DirectConnect interface, follow these steps to prepare the database for use:

1. Install and configure the SAP Sybase middleware data access products, network, and client software.
2. Install the DirectConnect interface.
3. Verify that you can connect to your middleware product and your database outside InfoMaker.
4. Create the extended attribute system tables outside InfoMaker.

Step 1: Install and configure the SAP Sybase middleware product

You must install and configure the SAP Sybase middleware data access product, network, and client software.

To install and configure the SAP Sybase middleware data access product, network, and client software:

1. Make sure the appropriate database software is installed and running on its server.
You must obtain the database server software from your database vendor.
For installation instructions, see your database vendor's documentation.
2. Make sure the appropriate DirectConnect access service software is installed and running on the DirectConnect server specified in your database profile.
or

Make sure the appropriate Open ServerConnect software is installed and running on the mainframe specified in your database profile.

3. Make sure the required network software (such as TCP/IP) is installed and running on your computer and is properly configured so you that can connect to the DirectConnect server or mainframe at your site.

You must install the network communication driver that supports the network protocol and operating system platform you are using.

For installation and configuration instructions, see your network or database administrator.

4. Install the required Open Client CT-Library (CT-Lib) software on each client computer on which InfoMaker is installed.

You must obtain the Open Client software from SAP. Make sure the version of Open Client you install supports both of the following:

The operating system running on the client computer

The version of InfoMaker that you are running

Required Open Client versions

To use the DirectConnect interface, you must install Open Client.

For information about Open Client, see your Open Client documentation.

5. Make sure the Open Client software is properly configured so you can connect to the middleware data access product at your site.

Installing the Open Client software places the SQL.INI configuration file in the SQL Server directory on your computer. SQL.INI provides information that SQL Server uses to find and connect to the middleware product at your site. You can enter and modify information in SQL.INI with the configuration utility or editor that comes with the Open Client software.

For information about editing the SQL.INI file, see [Editing the SQL.INI file](#). For more information about setting up SQL.INI or any other required configuration file, see your SQL Server documentation.

6. If required by your operating system, make sure the directory containing the Open Client software is in your system path.
7. Make sure only one copy of each of the following files is installed on your client computer:
 - DirectConnect interface DLL
 - Network communication DLL (such as NLWNSCK.DLL for Windows Sockets-compliant TCP/IP)
 - Open Client DLLs (such as LIBCT.DLL and LIBCS.DLL)

Step 2: Install the interface

In the InfoMaker Setup program, select the Typical install, or select the Custom install and select the Direct Connect Interface (DIR).

Step 3: Verify the connection

Make sure you can connect to the your middleware product and your database and log in to the database you want to access from outside InfoMaker.

Some possible ways to verify the connection are by running the following tools:

- Accessing the database server

Tools such as the Open Client/Open Server Configuration utility (or any Ping utility) check whether you can reach the database server from your computer.

- Accessing the database

Tools such as ISQL or SQL Advantage (interactive SQL utilities) check whether you can log in to the database and perform database operations. It is a good idea to specify the same connection parameters you plan to use in your InfoMaker database profile to access the database.

Step 4: Create the extended attribute system tables

InfoMaker uses a collection of five system tables to store extended attribute information. When using the DirectConnect interface, you must create the extended attribute system tables outside InfoMaker to control the access rights and location of these tables.

Run the DB2SYSPB.SQL script outside InfoMaker using the SQL tool of your choice.

For instructions, see [Creating the extended attribute system tables in DB2 databases](#).

Editing the SQL.INI file

Make sure the SQL.INI file provides an entry about either the access service being used and the DirectConnect server on which it resides or the Open ServerConnect program being used and the mainframe on which it resides.

For the server object name, you need to provide the exact access service name as it is defined in the access service library configuration file on the DirectConnect server. You must also specify the network communication DLL being used, the TCP/IP address or alias used for the DirectConnect server on which the access service resides, and the port on which the DirectConnect server listens for requests:

```
[access_service_name]
query=network_dll,server_alias,server_port_no
```

InfoMaker users must also specify the access service name in the SQLCA.ServerName property of the Transaction object.

6.7.6 Defining the DirectConnect interface

To define a connection through the DirectConnect interface, you must create a database profile by supplying values for at least the basic connection parameters in the Database Profile Setup - DirectConnect dialog box. You can then select this profile anytime to connect to your database in the development environment.

For information on how to define a database profile, see [Using database profiles](#).

6.8 Creating the extended attribute system tables in DB2 databases

This section describes how InfoMaker creates the extended attribute system tables in your DB2 database to store extended attribute information. It then explains how to use the DB2SYSPB.SQL script to create the extended attribute system tables outside InfoMaker.

You can use the DB2SYSPB.SQL script if you are connecting to the IBM DB2 family of databases through any of the following database interfaces:

- ODBC interface
- SAP Sybase DirectConnect interface

6.8.1 Creating the extended attribute system tables

When you create or modify a table in InfoMaker, the information you provide is stored in five system tables in your database. These system tables contain extended attribute information such as the text to use for labels and column headings, validation rules, display formats, and edit styles. (These system tables are different from the system tables provided by your DB2 database.)

By default, the extended attribute system tables are created automatically the first time a user connects to the database using InfoMaker.

When you use the DirectConnect interface

When you use the DirectConnect interface, the extended attribute system tables are not created automatically. You must run the DB2SYSPB.SQL script to create the system tables as described in [Using the DB2SYSPB.SQL script](#).

To ensure that the extended attribute system tables are created with the proper access rights:

- Make sure the first person to connect to the database with InfoMaker has sufficient authority to create tables and grant permissions to PUBLIC.
This means that the first person to connect to the database should log in as the database owner, database administrator, system user, system administrator, or system owner, as specified by your DBMS.

6.8.2 Using the DB2SYSPB.SQL script

Why do this

If you are a system administrator at a DB2 site, you might prefer to create the extended attribute system tables outside InfoMaker for two reasons:

- The first user to connect to the DB2 database using InfoMaker might not have the proper authority to create tables.
- When InfoMaker creates the extended attribute system tables, it places them in the default tablespace. This might not be appropriate for your needs.

When using the DirectConnect interface

You must create the extended attribute system tables outside InfoMaker if you are using the DirectConnect interface. You need to decide which database and tablespace should store the system tables. You might also want to grant update privileges only to specific developers or groups.

What you do

To create the extended attribute system tables, you run the DB2SYSPB.SQL script outside InfoMaker. This script contains SQL commands that create and initialize the system tables with the table owner and tablespace you specify.

Where to find DB2SYSPB.SQL

The DB2SYSPB.SQL script is in the Server directory on the InfoMaker installation package. This directory contains server-side installation components and is not installed with InfoMaker on your computer.

You can access the DB2SYSPB.SQL script by copying it to your computer.

Use the following procedure from the database server to create the extended attribute system tables in a DB2 database outside InfoMaker. This procedure assumes you are accessing the DB2SYSPB.SQL script in d:\server\.

To create the extended attribute system tables in a DB2 database outside InfoMaker:

1. Log in to the database server or gateway as the system administrator.
2. Use any text editor to modify d:\server\DB2SYSPB.SQL for your environment. You can do any of the following:
 - Change all instances of PBOwner to another name.
Specifying SYSIBM is prohibited
You cannot specify SYSIBM as the table owner. This is prohibited by DB2.
 - Change all instances of database.tablespace to the appropriate value.
 - Add appropriate SQL statement delimiters for the tool you are using to run the script.
 - Remove comments and blank lines if necessary.

PBCatalogOwner

If you changed PBOwner to another name in the DB2SYSPB.SQL script, you must specify the new owner name as the value for the PBCatalogOwner DBParm parameter in your database profile. For instructions, see PBCatalogOwner in the online Help.

3. Save any changes you made to the DB2SYSPB.SQL script.
4. Execute the DB2SYSPB.SQL script from the database server or gateway using the SQL tool of your choice.

Part IV. Working with Database Connections

This part describes how to establish, manage, and troubleshoot database connections.

7 Managing Database Connections

About this chapter

After you install the necessary database software and define the database interface, you can connect to the database from InfoMaker. Once you connect to the database, you can work with the tables and views stored in that database.

This chapter describes how to connect to a database in InfoMaker, maintain database profiles, and share database profiles.

Terminology

In this chapter, the term database refers to both of the following unless otherwise specified:

- A database or DBMS that you access with a standard database interface and appropriate driver
- A database or DBMS that you access with the appropriate native database interface

7.1 About database connections

This section gives an overview of when database connections occur in InfoMaker. It also tells why you should use database profiles to manage your database connections.

7.1.1 When database connections occur

Connections in InfoMaker

In the development environment, the setting of the Automatically Connect to Database system option controls whether InfoMaker connects to the database when you open a painter requiring a connection (the default) or automatically when you start InfoMaker.

The Automatically Connect to Database option has no effect in InfoMaker applications at runtime. Like PowerBuilder, InfoMaker connects to your database when you run an application that accesses the database.

To set the Automatically Connect to Database option in InfoMaker:

1. Select Windows>System Options from the PowerBar.

The System Options dialog box displays.

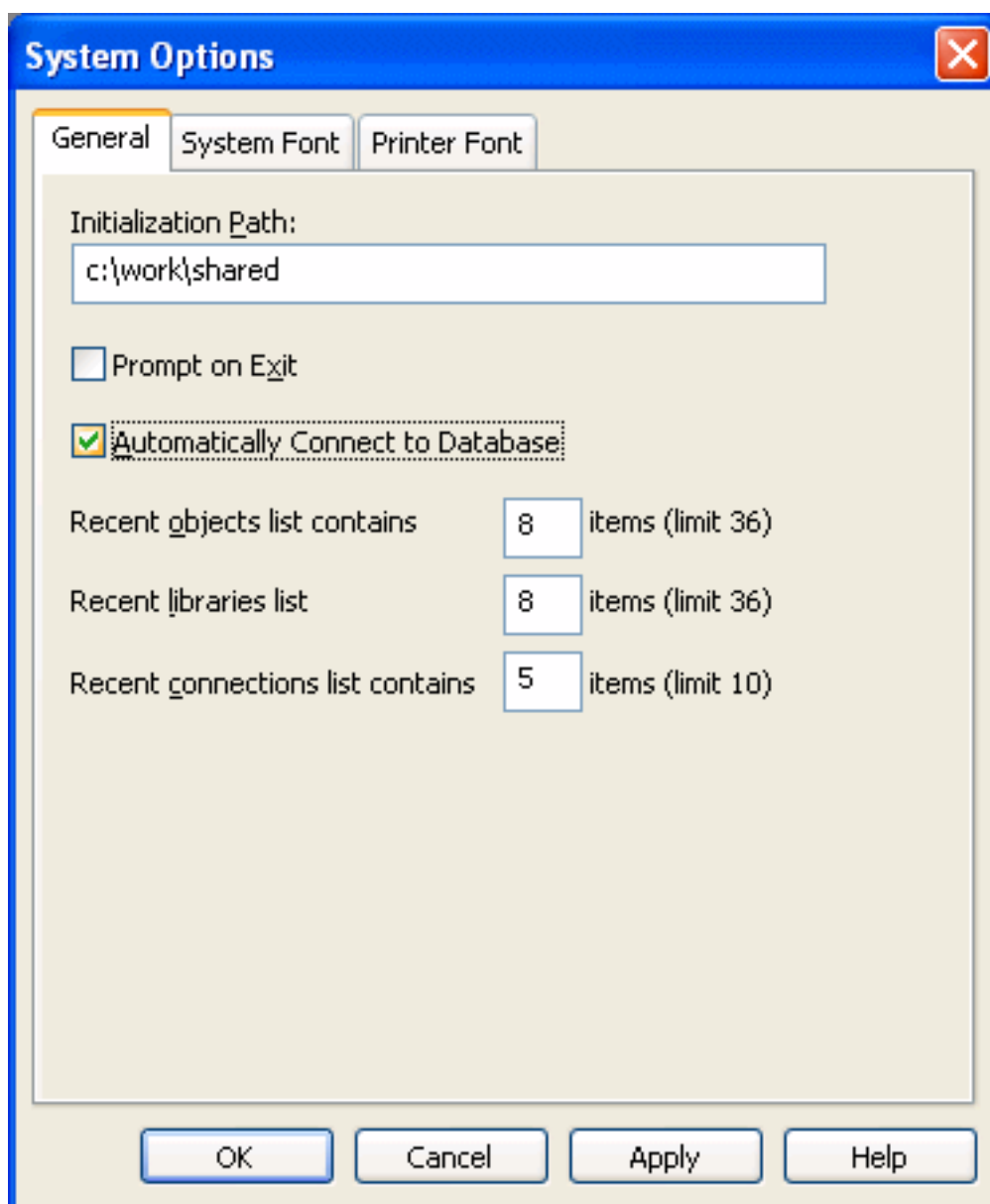

2. On the General tab page, select or clear the Automatically Connect to Database check box as follows:

Select the check box

The next time you start InfoMaker, it automatically connects to the database at startup and stays connected throughout the session until you exit.

Clear the check box

(Default) The next time you start InfoMaker, it connects to the database only when you open one of the following painters requiring a connection: Database, Report, Form, Data Pipeline, or Query. It does not connect to the database automatically at startup.

3. Click OK or Apply.

InfoMaker saves your AutoConnect setting in the registry.

How InfoMaker determines the database to access

InfoMaker connects to the database you used last when you open a painter that accesses the database. InfoMaker determines which database you used last by reading a setting in the registry.

What's in this book

This book describes how to connect to your database when you are working in the InfoMaker development environment.

7.1.2 Using database profiles

What is a database profile?

A database profile is a named set of parameters stored in the registry that defines a connection to a particular database in the InfoMaker development environment.

Why use database profiles?

Creating and using database profiles is the easiest way to manage your database connections in InfoMaker because you can:

- Select a database profile to establish or change database connections. You can easily connect to another database anytime during an InfoMaker session. This is particularly useful if you often switch between different database connections.
- Edit a database profile to modify or supply additional connection parameters.
- Delete a database profile if you no longer need to access that data.
- Import and export profiles.

Because database profiles are created when you define your data and are stored in the registry, they have the following benefits:

- They are always available to you.
- Connection parameters supplied in a database profile are saved until you edit or delete the database profile.

7.2 Connecting to a database

To establish or change a database connection in InfoMaker, use a database profile. You can select the database profile for the database you want to access in the Database Profiles dialog box.

Using the Database painter to select a database profile

The Database painter is an optional InfoMaker painter. If the Database painter is installed, you can select the database profile for the database you want to access from the Database painter's Objects view. However, this method uses more system resources than using the Database Profile dialog box.

7.2.1 Selecting a database profile

You can select a database profile from the Database Profiles dialog box.

To connect to a database using the Database Profiles dialog box:

Database Profile button

If your PowerBar does not include the Database Profile button, use the customize feature to add the button to the PowerBar. Having the Database Profile button on your PowerBar is useful if you frequently switch connections between different databases. For instructions on customizing toolbars, see the User's Guide.

The Database Profiles dialog box displays, listing your installed database interfaces.

Where the interface list comes from

When you run the Setup program, it updates the Vendors list in the registry with the interfaces you install. The Database Profiles dialog box displays the same interfaces that appear in the Vendors list.

1. Click the Database Profile button in the PowerBar.
or
Select Tools>Database Profile from the PowerBar.
2. Click the plus sign (+) to the left of the interface you are using.
or
Double-click the name.
The list expands to display the database profiles defined for your interface.
3. Select the name of the database profile you want to access and click Connect.
or
Display the pop-up menu for a database profile and select Connect.
InfoMaker connects to the specified database and returns you to the painter workspace.

Database painter Objects view

You can select a database profile from the Database painter Objects view.

To connect to a database using the Database painter:

1. Click the Database painter button in the PowerBar.
The Database painter displays. The Objects view lists your installed database interfaces.

Where the interface list comes from

When you run the Setup program, it updates the Vendors list in the registry with the interfaces you install. The Database painter Objects view displays the same interfaces that appear in the Vendors list.

2. Click the plus sign (+) to the left of the interface you are using.
or
Double-click the name.
The list expands to display the database profiles defined for your interface.
3. Select the name of the database profile you want to access and click the Connect button.
or
Display the pop-up menu for a database profile and select Connect.

7.2.2 What happens when you connect

Connection parameters

When you connect to a database by selecting its database profile, InfoMaker writes the profile name and its connection parameters to the registry key HKEY_CURRENT_USER\Software\Sybase\PowerBuilder\18.0\DatabaseProfiles\PowerBuilder.

Each time you connect to a different database, InfoMaker overwrites the "most-recently used" profile name in the registry with the name for the new database connection.

What you get connected to

When you start InfoMaker (with the Automatically Connect to Database system option selected) or open a painter that accesses the database, you are connected to the database you used last. InfoMaker determines which database this is by reading the registry.

7.2.3 Specifying passwords in database profiles

As shown in the completed Database Profile Setup dialog box for Employees, your password does not display when you specify it in the Database Profile Setup dialog box.

However, when InfoMaker stores the values for this profile in the registry, the actual password does display, albeit in encrypted form, in the DatabasePassword or LogPassword field.

Suppressing display in the profile registry entry

To suppress password display in the profile registry entry, do the following when you create a database profile.

To suppress password display in the profile registry entry:

1. Select the Prompt For Database Information check box on the Connection tab in the Database Profile Setup dialog box.
This tells InfoMaker to prompt for any missing information when you select this profile to connect to the database.
2. Leave the Password box blank. Instead, specify the password in the dialog box that displays to prompt you for additional information when you connect to the database.

What happens

When you specify the password in response to a prompt instead of in the Database Profile Setup dialog box, the password does not display in the registry entry for this profile.

For example, if you do not supply a password in the Database Profile Setup - Adaptive Server Enterprise dialog box when creating a database profile, the Client Library Login dialog box displays to prompt you for the missing information.

7.3 Maintaining database profiles

You can easily edit or delete an existing database profile in InfoMaker.

You can edit a database profile to change one or more of its connection parameters. You can delete a database profile when you no longer need to access its data. You can also change a profile using either the Database Profile dialog box or the Database painter.

What happens

When you edit or delete a database profile, InfoMaker either updates the database profile entry in the registry or removes it.

Deleting a profile for an ODBC data source

If you delete a database profile that connects to an ODBC data source, InfoMaker does not delete the corresponding data source definition from the ODBC initialization file. This lets you re-create the database profile later if necessary without having to redefine the data source.

7.4 Sharing database profiles

When you work in InfoMaker, you can share database profiles among users.

Sharing database profiles between SAP tools

Since the database profiles used by PowerBuilder, InfoMaker, and DataWindow Designer are stored in a common registry location, database profiles you create in any of these tools are automatically available for use by the others, if the tools are running on the same computer.

This section describes what you need to know to set up, use, and maintain shared database profiles in InfoMaker.

7.4.1 About shared database profiles

What you can do

You can share database profiles in the InfoMaker development environment by specifying the location of a file containing the profiles you want to share. You specify this location in the Database Preferences property sheet in the Database painter.

Where to store a shared profile file

To share database profiles among all InfoMaker users at your site, store a profile file on a network file server accessible to all users.

What happens

When you share database profiles, InfoMaker displays shared database profiles from the file you specify as well as those from your registry.

Shared database profiles are read-only. You can select a shared profile to connect to a database -- but you cannot edit, save, or delete profiles that are shared. (You can, however, make changes to a shared profile and save it on your computer, as described in [Making local changes to shared database profiles.](#))

How to do it

To set up shared database profiles in InfoMaker, you specify the location of the file containing shared profiles in the Database painter's Database Preferences property sheet.

For instructions, see [Setting up shared database profiles.](#)

7.4.2 Setting up shared database profiles

What you do

You set up shared database profiles in the Database Preferences property sheet.

To set up shared database profiles:

1. In the Database painter, select Design>Options from the menu bar.
The Database Preferences property sheet displays. If necessary, click the General tab to display the General property page.
2. In the Shared Database Profiles box, specify the location of the file containing the database profiles you want to share. Do this in either of the following ways:
 - Type the location (path name) in the Shared Database Profiles box.
 - Click the Browse button to navigate to the file location and display it in the Shared Database Profiles box.

In the following example, c:\work\share.ini is the location of the file containing the database profiles to be shared:

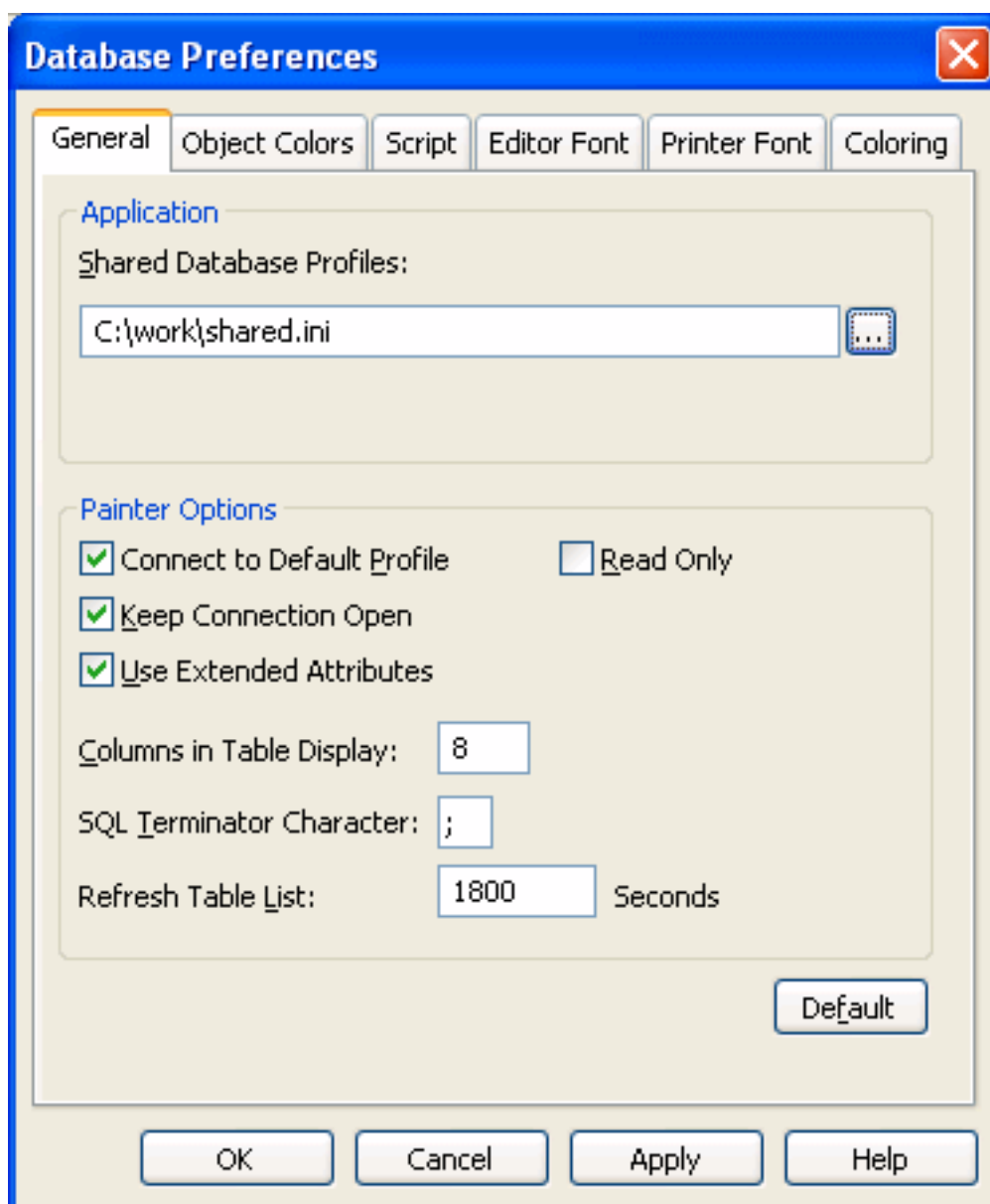

3. Do one of the following:

- Click Apply to apply the Shared Database Profiles setting to the current connection and all future connections without closing the Database Preferences property sheet.
- Click OK to apply the Shared Database Profiles setting to the current connection and all future connections and close the Database Preferences property sheet.

InfoMaker saves your Shared Database Profiles setting in the registry.

7.4.3 Using shared database profiles to connect

You select a shared database profile to connect to a database the same way you select a profile stored in your registry. You can select the shared profile in the Database Profiles dialog box or from the File>Connect menu.

Database Profiles dialog box

You can select and connect to a shared database profile in the Database Profiles dialog box.

To select a shared database profile in the Database Profiles dialog box:

1. Click the Database Profile button in the PowerBar.

or

Select Tools>Database Profile from the PowerBar.

The Database Profiles dialog box displays, listing both shared and local profiles. Shared profiles are denoted by a network icon and the word (Shared).

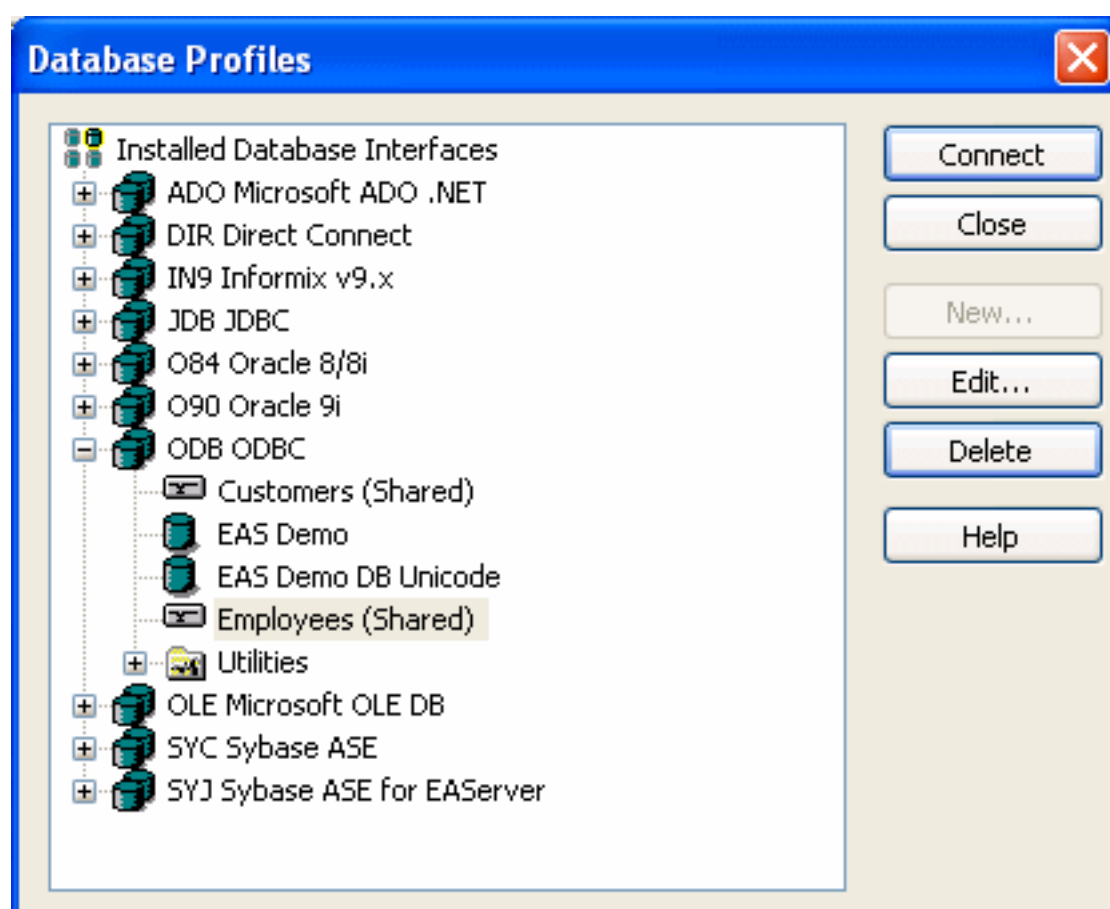

2. Select the name of the shared profile you want to access and click Connect.

InfoMaker connects to the selected database and returns you to the painter workspace.

7.4.4 Making local changes to shared database profiles

Because shared database profiles can be accessed by multiple users running InfoMaker, you should not make changes to these profiles. However, if you want to modify and save a copy of a shared database profile for your own use, you can edit the profile and save the modified copy in your computer's registry.

To save changes to a shared database profile in your registry:

1. In the Database Profiles dialog box, select the shared profile you want to edit and click the Edit button.
2. In the Database Profile Setup dialog box that displays, edit the profile values as needed and click OK.

A message box displays, asking if you want to save a copy of the modified profile to your computer.

3. Click Yes.

InfoMaker saves the modified profile in your computer's registry.

7.4.5 Maintaining shared database profiles

If you maintain the database profiles for InfoMaker at your site, you might need to update shared database profiles from time to time and make these changes available to your users.

Because shared database profiles can be accessed by multiple users running InfoMaker, it is not a good idea to make changes to the profiles over a network. Instead, you should make any changes locally and then provide the updated profiles to your users.

To maintain shared database profiles at your site:

1. Make and save required changes to the shared profiles on your own computer. These changes are saved in your registry.

For instructions, see [Making local changes to shared database profiles](#).

2. Export the updated profile entries from your registry to the existing file containing shared profiles.

For instructions, see [Importing and exporting database profiles](#).

3. If they have not already done so, have each user specify the location of the new profiles file in the Database Preferences property sheet so that they can access the updated shared profiles on their computer.

For instructions, see [Setting up shared database profiles](#).

7.5 Importing and exporting database profiles

Why do this

Each database interface provides an Import Profile(s) and an Export Profile(s) option. You can use the Import option to import a previously defined profile for use with an installed database interface. Conversely, you can use the Export option to export a defined profile for use by another user.

The ability to import and export profiles provides a way to move profiles easily between developers. It also means you no longer have to maintain a shared file to maintain profiles. It

is ideal for mobile development when you cannot rely on connecting to a network to share a file.

What you do

This section describes how to import and export a profile.

To import a profile:

1. Highlight a database interface and select Import Profile(s) from the pop-up menu. (In the Database painter, select Import Profile(s) from the File or pop-up menu.)
2. From the Select Profile File dialog box, select the file whose profiles you want to import and click Save.
3. Select the profile(s) you want to import from the Import Profile(s) dialog box and click OK.

The profiles are copied into your registry. If a profile with the same name already exists, you are asked if you want to overwrite it.

To export a profile:

1. Highlight a database interface and select Export Profile(s) from the pop-up menu. (In the Database painter, select Export Profile(s) from the File or pop-up menu.)
2. Select the profile(s) you want to export from the Export Profile(s) dialog box and click OK.

The Export Profile(s) dialog box lists all profiles defined in your registry regardless of the database interface for which they were defined. By default, the profiles defined for the selected database interface are marked for export.

3. From the Select Profile File dialog box, select a directory and a file in which to save the exported profile(s) and click Save.

The exported profiles can be saved to a new or existing file. If saved to an existing file, the profile(s) are added to the existing profiles. If a profile with the same name already exists, you are asked if you want to overwrite it.

7.6 About the InfoMaker extended attribute system tables

InfoMaker uses a collection of five system tables (formerly known as the Powersoft repository) to store extended attribute information (such as display formats, validation rules, and font information) about tables and columns in your database. You can also define extended attributes when you create or modify a table in InfoMaker.

This section tells you how to:

- Make sure the InfoMaker extended attribute system tables are created with the proper access rights when you log in to your database for the first time

- Display and open an InfoMaker extended attribute system table
- Understand the kind of information stored in the InfoMaker extended attribute system tables
- Control extended attribute system table access

7.6.1 Logging on to your database for the first time

By default, InfoMaker creates the extended attribute system tables the first time you connect to a database.

To ensure that InfoMaker creates the extended attribute system tables with the proper access rights to make them available to all users, the first person to connect to the database with InfoMaker must log in with the proper authority.

To ensure proper creation of the InfoMaker extended attribute system tables:

- Make sure the first person to connect to the database with InfoMaker has sufficient authority to create tables and grant permissions to PUBLIC.

This means that the first person to connect to the database should log in as the database owner, database administrator, system user, system administrator, or system owner, as specified by your DBMS.

Creating the extended attribute system tables when using the DirectConnect interface

When you are using the DirectConnect interface, the InfoMaker extended attribute system tables are not created automatically the first time you connect to a database. You must run the DB2SYSPB.SQL script to create the system tables, as described in [Using the DB2SYSPB.SQL script](#).

7.6.2 Displaying the InfoMaker extended attribute system tables

InfoMaker updates the extended attribute system tables automatically whenever you change the information for a table or column. The InfoMaker extended attribute system tables are different from the system tables provided by your DBMS.

You can display and open InfoMaker extended attribute system tables in the Database painter just like other tables.

To display the InfoMaker extended attribute system tables:

1. In the Database painter, highlight Tables in the list of database objects for the active connection and select Show System Tables from the pop-up menu.

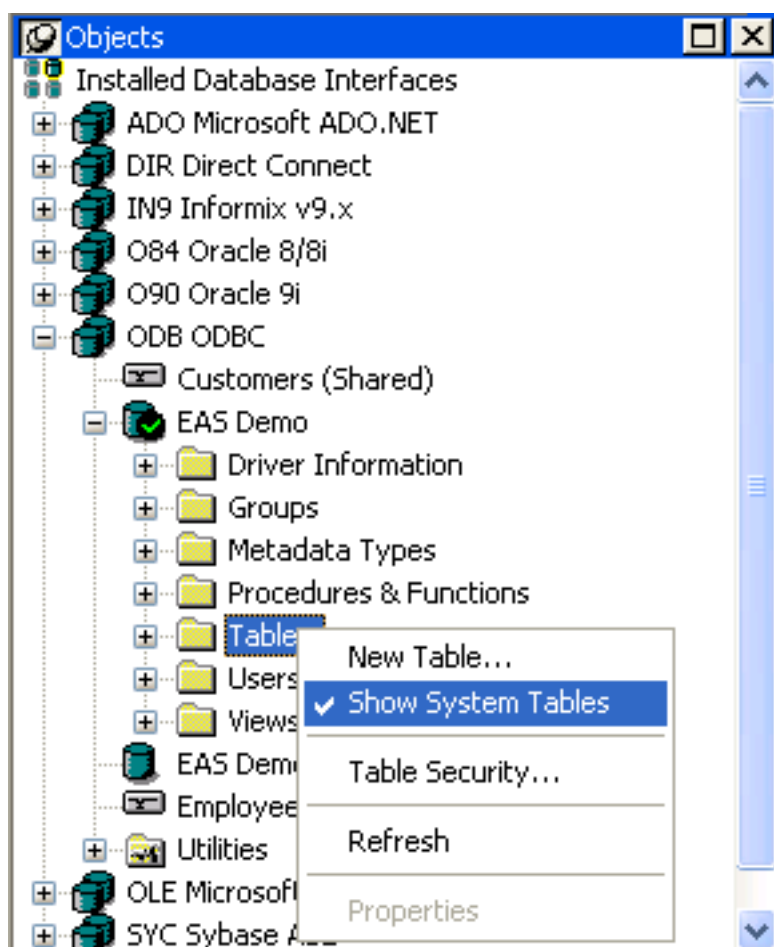

2. The InfoMaker extended attribute system tables and DBMS system tables display in the tables list, as follows:

- InfoMaker system tables

The five system tables are: pbcacol, pbcatedt, pbcatfmt, pbcattbl, and pbcavld.

- DBMS system tables

The system tables supplied by the DBMS usually have a DBMS-specific prefix (such as sys or dbo).

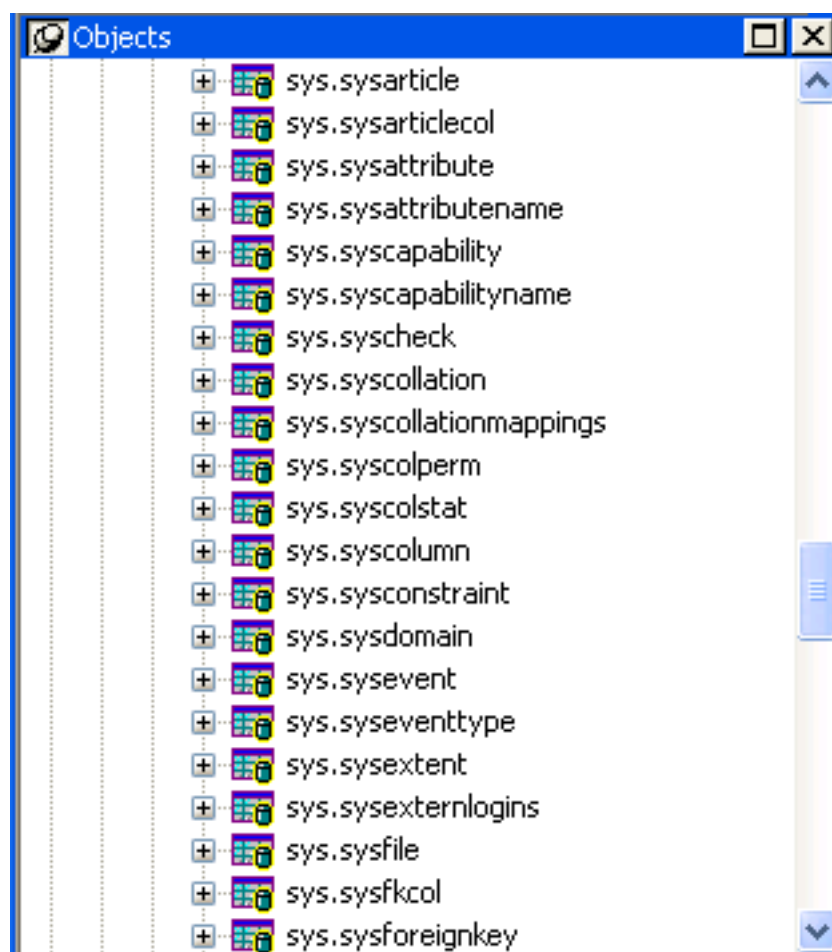

3. Display the contents of a InfoMaker system table in the Object Layout, Object Details, and/or Columns views.

For instructions, see the User's Guide.

Do not edit the extended attribute system tables

Do not change the values in the InfoMaker extended attribute system tables.

7.6.3 Contents of the extended attribute system tables

InfoMaker stores five types of extended attribute information in the system tables as described in the following table.

Table 7.1: Extended attribute system tables

System table	Information about	Attributes
pbcatcol	Columns	Names, comments, headers, labels, case, initial value, and justification
pbcatedt	Edit styles	Edit style names and definitions
pbcatfmt	Display formats	Display format names and definitions
pbcattbl	Tables	Name, owner, default fonts (for data, headings and labels), and comments

System table	Information about	Attributes
pbcatvld	Validation rules	Validation rule names and definitions

For more about the InfoMaker system tables, see the Appendix in the User's Guide.

Prefixes in system table names

For some databases, InfoMaker precedes the name of the system table with a default DBMS-specific prefix. For example, the names of InfoMaker system tables have the prefix DBO in a SQL Server database (such as DBO.pbcatcol), or SYSTEM in an ORACLE database (such as SYSTEM.pbcatfmt).

The preceding table gives the base name of each system table without the DBMS-specific prefix.

7.6.4 Controlling system table access

To control access to the InfoMaker system tables at your site, you can specify that InfoMaker not create or update the system tables or that the system tables be accessible only to certain users or groups.

You can control system table access by doing any of the following:

- **Setting Use Extended Attributes**
Set the Use Extended Attributes database preference in the Database Preferences property sheet in the Database painter.
- **Setting Read Only**
Set the Read Only database preference in the Database Preferences property sheet in the Database painter.
- **Granting permissions on the system tables**
Grant explicit permissions on the system tables to users or groups at your site.

7.6.4.1 Setting Use Extended Attributes or Read Only to control access

To control system table access by setting Use Extended Attributes or Read Only:

1. Select Design>Options from the menu bar.
The Database Preferences dialog box displays. If necessary, click the General tab to display the General property page.

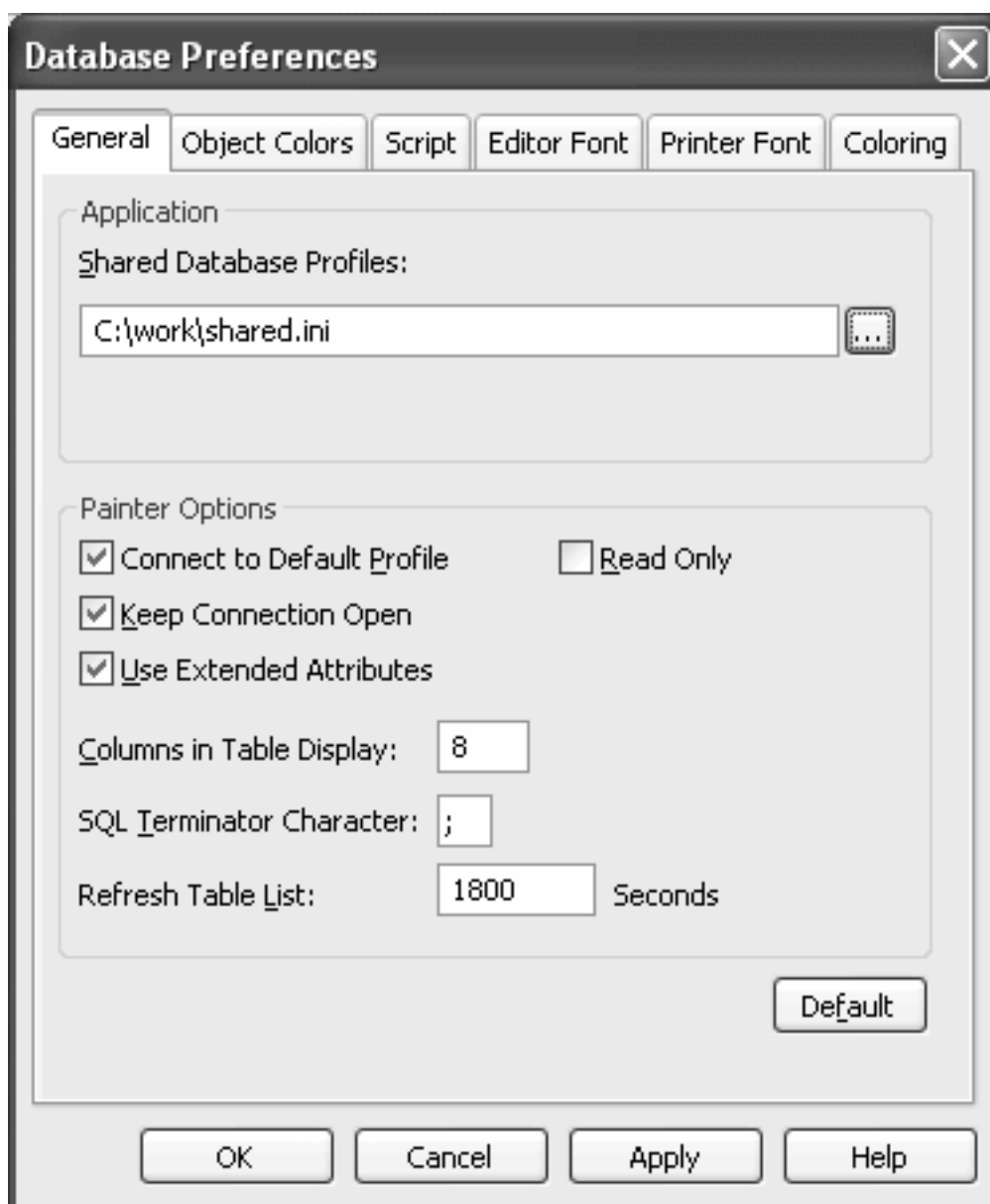

- Set values for Use Extended Attributes or Read Only as follows:

Table 7.2:

Preference	What you do	Effect
Use Extended Attributes	Clear the check box	Does not create the InfoMaker system tables if they do not exist. Instead, the painter uses the appropriate default values for extended attributes (such as headers, labels, and text color). If the InfoMaker system tables already exist, InfoMaker does not use them when you create a new report or form.

Preference	What you do	Effect
Read Only	Select the check box	If the InfoMaker system tables already exist, InfoMaker uses them when you create a new report or form, but does not update them. You cannot modify (update) information in the system tables or any other database tables in the DataWindow painter or Form painter when the Read Only check box is selected.

3. Do one of the following:

- Click Apply to apply the preference settings to the current connection and all future connections without closing the Database Preferences property sheet.
- Click OK to apply the preference settings to the current connection and all future connections and close the Database Preferences property sheet.

InfoMaker saves your preference settings in the registry.

7.6.4.2 Granting permissions on system tables to control access

If your DBMS supports SQL GRANT and REVOKE statements, you can control access to the InfoMaker system tables. The default authorization for each repository table is:

```
GRANT SELECT, UPDATE, INSERT, DELETE ON table TO PUBLIC
```

After the system tables are created, you can (for example) control access to them by granting SELECT authority to end users and SELECT, UPDATE, INSERT, and DELETE authority to developers. This technique offers security and flexibility that is enforced by the DBMS itself.

8 Setting Additional Connection Parameters

About this chapter

To fine-tune your database connection and take advantage of DBMS-specific features that your interface supports, you can set additional connection parameters at any time. These additional connection parameters include:

- Database parameters
- Database preferences

These connection parameters are described in the Database Connectivity section in the online Help.

This chapter describes how to set database parameters and database preferences in InfoMaker.

8.1 Basic steps for setting connection parameters

This section gives basic steps for setting database parameters and database preferences in InfoMaker.

To set database parameters:

1. Learn how to set database parameters in the development environment.
See [Setting database parameters](#).
2. Determine the database parameters you can set for your database interface.
For a table listing each supported database interface and the database parameters you can use with that interface, see "Database parameters and supported database interfaces" in the online Help.
3. Read the description of the database parameter you want to set in the online Help.
4. Set the database parameter for your database connection.

To set database preferences:

1. Learn how to set database preferences in the development environment.
See [Setting database preferences](#).
2. Determine the database preferences you can set for your DBMS.
For a table listing each supported database interface and the database preferences you can use with that interface, see "database parameters and supported database interfaces" in the online Help.
3. Read the description of the database preference you want to set in the online Help.
4. Set the database preference for your database connection.

8.2 About the Database Profile Setup dialog box

The interface-specific Database Profile Setup dialog box makes it easy to set additional connection parameters in the development environment. You can:

- Supply values for connection options supported by your database interface

Each database interface has its own Database Profile Setup dialog box that includes settings only for those connection parameters supported by the interface. Similar parameters are grouped on the same tab page. The Database Profile Setup dialog box for all interfaces includes the Connection tab. Depending on the requirements and features of your interface, one or more other tab pages might also display.

- Easily set additional connection parameters in the development environment

You can specify additional connection parameters (database parameters and transaction object properties) with easy-to-use check boxes, drop-down lists, and text boxes.

InfoMaker generates the proper syntax automatically when it saves your database profile in the system registry.

8.3 Setting database parameters

In InfoMaker, you can set database parameters by editing the Database Profile Setup dialog box for your connection.

8.3.1 Setting database parameters in the development environment

Editing database profiles

To set database parameters for a database connection in the InfoMaker development environment, you must edit the database profile for that connection.

Character limit for strings

Strings containing database parameters that you specify in the Database Profile Setup dialog box for your connection can be up to 999 characters in length.

What you do

You set database parameters in the Database Profile Setup dialog box for your connection.

8.4 Setting database preferences

How to set

The way you set connection-related database preferences in InfoMaker varies, as summarized in the following table.

Table 8.1: Database preferences and where they can be set

Database preference	Set in development environment by editing
AutoCommit	Database Profile Setup dialog box for your connection
Lock	Database Profile Setup dialog box for your connection

Database preference	Set in development environment by editing
Shared Database Profiles	Database Preferences property sheet
Connect DB at Startup	Database Preferences property sheet
Connect to Default Profile	Database Preferences property sheet
Read Only	Database Preferences property sheet
Keep Connection Open	Database Preferences property sheet
Use Extended Attributes	Database Preferences property sheet
SQL Terminator Character	Database Preferences property sheet

The following sections give the steps for setting database preferences in the development environment.

For more information

For information about using a specific database preference, see its description in the online Help.

8.4.1 Setting database preferences in the development environment

There are two ways to set database preferences in the InfoMaker development environment on all supported development platforms, depending on the preference you want to set:

- Set AutoCommit and Lock (Isolation Level) in the Database Profile Setup dialog box for your connection

ADO.NET

For ADO.NET, Isolation is a database parameter.

- Set all other database preferences in the Database Preferences property sheet in the Database painter

8.4.1.1 Setting AutoCommit and Lock in the database profile

The AutoCommit and Lock (Isolation Level) preferences are properties of the default Transaction object, SQLCA. For AutoCommit and Lock to take effect in the InfoMaker development environment, you must specify them before you connect to a database. Changes to these preferences after the connection occurs have no effect on the current connection.

To set AutoCommit and Lock before InfoMaker connects to your database, you specify their values in the Database Profile Setup dialog box for your connection.

To set AutoCommit and Lock (Isolation Level) in a database profile:

1. Display the Database Profiles dialog box.
2. Click the plus sign (+) to the left of the interface you are using.
or
Double-click the interface name.

The list expands to display the database profiles defined for your interface.

3. Select the name of the profile you want and click Edit.

The Database Profile Setup dialog box for the selected profile displays.

4. On the Connection tab page, supply values for one or both of the following:

- Isolation Level

If your database supports the use of locking and isolation levels, select the isolation level you want to use for this connection from the Isolation Level drop-down list. (The Isolation Level drop-down list contains valid lock values for your interface.)

- AutoCommit Mode

The setting of AutoCommit controls whether InfoMaker issues SQL statements outside (True) or inside (False) the scope of a transaction. If your database supports it, select the AutoCommit Mode check box to set AutoCommit to True or clear the AutoCommit Mode check box (the default) to set AutoCommit to False.

For example, in addition to values for basic connection parameters (Server, Login ID, Password, and Database), the Connection tab page for the following SAP Adaptive Server Enterprise profile named Sales shows nondefault settings for Isolation Level and AutoCommit Mode.

5. Click OK to close the Database Profile Setup dialog box.

InfoMaker saves your settings in the database profile entry in the registry.

8.4.1.2 Setting preferences in the Database Preferences property sheet

To set the following connection-related database preferences, complete the Database Preferences property sheet in the InfoMaker Database painter:

- Shared Database Profiles
- Connect to Default Profile
- Read Only
- Keep Connection Open
- Use Extended Attributes
- SQL Terminator Character

Other database preferences

The Database Preferences property sheet also lets you set other database preferences that affect the behavior of the Database painter itself. For information about the other preferences you can set in the Database Preferences property sheet, see the User's Guide.

To set connection-related preferences in the Database Preferences property sheet:

1. Open the Database painter.
2. Select Design>Options from the menu bar.

The Database Preferences dialog box displays. If necessary, click the General tab to display the General property page.

3. Specify values for one or more of the connection-related database preferences in the following table.

Table 8.2: Connection-related database preferences

Preference	Description	For details, see
Shared Database Profiles	Specifies the pathname of the file containing the database profiles you want to share. You can type the pathname or click Browse to display it.	Sharing database profiles
Connect to Default Profile at Startup	<p>Specifies when InfoMaker connects to the database. Select or clear the check box as follows:</p> <ul style="list-style-type: none"> • Select the check box The next time you start InfoMaker, it automatically connects to the database at startup and stays connected throughout the session until you exit. • Clear the check box (Default) The next time you start InfoMaker, it connects to the database only when you open a painter requiring a connection. 	Connect DB at Startup in the online Help
Connect to Default Profile	Controls whether the Database painter establishes a connection to a database using a default profile when the painter is invoked. If not selected, the Database painter opens without establishing a connection to a database.	Connect to Default Profile in online Help
Read Only	<p>Specifies whether InfoMaker should update the extended attribute system tables and any other tables in your database. Select or clear the Read Only check box as follows:</p> <ul style="list-style-type: none"> • Select the check box Does not update the extended attribute system tables or any other tables in your database. You cannot modify (update) information in the extended attribute system tables or any other database tables from the Report and Form painters when the Read Only check box is selected. 	Read Only in the online Help

Preference	Description	For details, see
	<ul style="list-style-type: none"> • Clear the check box <p>(Default) Updates the extended attribute system tables and any other tables in your database.</p>	
Keep Connection Open	<p>When you connect to a database in PowerBuilder without using a database profile, specifies when PowerBuilder closes the connection. Select or clear the Keep Connection Open check box as follows:</p> <ul style="list-style-type: none"> • Select the check box <p>(Default) Stays connected to the database throughout your session and closes the connection when you exit</p> <ul style="list-style-type: none"> • Clear the check box <p>Opens the connection only when a painter requests it and closes the connection when you close a painter or finish compiling a script</p> <p>PowerBuilder only</p> <p>Keep Connection Open has no effect in InfoMaker.</p>	Keep Connection Open in the online Help
Use Extended Attributes	<p>Specifies whether InfoMaker should create and use the extended attribute system tables. Select or clear the Use Extended Attributes check box as follows:</p> <ul style="list-style-type: none"> • Select the check box <p>(Default) Creates and uses the extended attribute system tables</p> <ul style="list-style-type: none"> • Clear the check box <p>Does not create the extended attribute system tables</p>	Use Extended Attributes in the online Help
Columns in Table Display	Specify the number of table columns to be displayed when InfoMaker displays a table graphically. The default is eight.	
SQL Terminator Character	<p>Specifies the SQL statement terminator character used in the ISQL view in the Database painter in InfoMaker.</p> <p>The default terminator character is a semicolon (;). If you are creating stored procedures and triggers in the ISQL view of the database painter, change the terminator character to one that you do not expect to</p>	SQL Terminator Character in the online Help

Preference	Description	For details, see
	use in the stored procedure or trigger syntax for your DBMS. A good choice is the backquote (`) character.	
Refresh Table List	Specify how frequently you want the table list to be refreshed from the database. The default is 30 minutes.	

4. Do one of the following:

- Click **Apply** to apply the preference settings to the current connection without closing the Database Preferences property sheet.
- Click **OK** to apply the preference settings to the current connection and close the Database Preferences property sheet.

InfoMaker saves your preference settings in the database section of IM.INI.

9 Troubleshooting Your Connection

About this chapter

This chapter describes how to troubleshoot your database connection in InfoMaker by using the following tools:

- Database Trace
- ODBC Driver Manager Trace
- JDBC Driver Manager Trace

9.1 Overview of troubleshooting tools

When you use InfoMaker, there are several tools available to trace your database connection in order to troubleshoot problems:

Table 9.1: Database trace tools

Use this tool	To trace a connection to
Database Trace	Any database that InfoMaker accesses through one of the database interfaces
ODBC Driver Manager Trace	An ODBC data source only
JDBC Driver Manager Trace	A JDBC database only

9.2 Using the Database Trace tool

The section describes how to use the Database Trace tool.

9.2.1 About the Database Trace tool

The Database Trace tool records the internal commands that InfoMaker executes while accessing a database. You can trace a database connection in the development environment.

InfoMaker writes the output of Database Trace to a log file named PBTRACE.LOG (by default) or to a nondefault log file that you specify. When you enable database tracing for the first time, InfoMaker creates the log file on your computer. Tracing continues until you disconnect from the database.

Using the Database Trace tool with one connection

You can use the Database Trace tool for only one DBMS at a time and for one database connection at a time.

For example, if your application connects to both an ODBC data source and an Adaptive Server Enterprise database, you can trace either the ODBC connection or the Adaptive Server Enterprise connection, but not both connections at the same time.

9.2.1.1 How you can use the Database Trace tool

You can use information from the Database Trace tool to help you understand what InfoMaker is doing internally when you work with your database. Examining the information in the log file can help you:

- Understand how InfoMaker interacts with your database
- Identify and resolve problems with your database connection
- Provide useful information to Technical Support if you call them for help with your database connection

If you are familiar with InfoMaker and your DBMS, you can use the information in the log to help troubleshoot connection problems on your own.

If you are less experienced or need help, run the Database Trace tool before you call Technical Support. You can then report or send the results of the trace to the Technical Support representative who takes your call.

9.2.1.2 Location of the Database Trace log

PBTRACE.LOG

By default, InfoMaker writes output of the Database Trace tool to a file named PBTRACE.LOG in your Windows directory.

Nondefault log file

If you prefer, you can specify a nondefault name and location for the log file when you use Database Trace. For instructions, see [Specifying a nondefault Database Trace log](#).

9.2.1.3 Contents of the Database Trace log

The Database Trace tool records the following information in the log file when you trace a database connection:

- Parameters used to connect to the database
- Time to perform each database operation (in milliseconds)
- The internal commands executed to retrieve and display table and column information from your database. Examples include:
 - Preparing and executing SQL statements such as SELECT, INSERT, UPDATE, and DELETE
 - Getting column descriptions
 - Fetching table rows
 - Binding user-supplied values to columns (if your database supports bind variables)
 - Committing and rolling back database changes
 - Disconnecting from the database
 - Shutting down the database interface

9.2.1.4 Format of the Database Trace log

The specific content of the Database Trace log file depends on the database you are accessing and the operations you are performing. However, the log uses the following basic format to display output:

```
COMMAND: (time)
        {additional_information}
```

Table 9.2:

Parameter	Description
COMMAND	The internal command that InfoMaker executes to perform the database operation.
time	The number of milliseconds it takes InfoMaker to perform the database operation. The precision used depends on your operating system's timing mechanism.
additional_info	(Optional) Additional information about the command. The information provided depends on the database operation.

Example

The following portion of the log file shows the commands InfoMaker executes to fetch two rows from a database table:

```
FETCH NEXT: (77 MilliSeconds)
    dept_id=    dept_name=Business Services
FETCH NEXT: (4 MilliSeconds)
    dept_id=    dept_name=Corporate Management
```

For a more complete example of Database Trace output, see [Sample Database Trace output](#).

9.2.2 Starting the Database Trace tool

By default, the Database Trace tool is turned off in InfoMaker. You can start it to trace your database connection.

To start the Database Trace tool:

1. Open the Database Profile Setup dialog box for the connection you want to trace.
2. On the Connection tab, select the Generate Trace check box and click OK or Apply. (The Generate Trace check box is located on the System tab in the OLE DB Database Profile Setup dialog box.)

The Database Profiles dialog box displays with the name of the edited profile highlighted.

For example, here is the relevant portion of a database profile entry for Adaptive Server 12.5 Test. The setting that starts Database Trace is DBMS:

```
[Default]      [value not set]
AutoCommit     "FALSE"
Database       "qadata"
DatabasePassword "00"
DBMS           "TRACE SYC Adaptive Server Enterprise"
DbParm         "Release='12.5' "
```

```
Lock          " "  
LogId         "qalotin"  
LogPassword   "0017171717171717"  
Prompt       "FALSE"  
ServerName    "Host125"  
UserID        " "
```

3. Click Connect in the Database Profiles dialog box to connect to the database.

A message box displays stating that database tracing is enabled and indicating where InfoMaker will write the output. (By default, InfoMaker writes Database Trace output to a log file named PBTRACE.LOG.)

For instructions on specifying your own name and location for the Database Trace log file, see [Specifying a nondefault Database Trace log](#).

4. Click OK.

InfoMaker connects to the database and starts tracing the connection.

9.2.3 Stopping the Database Trace tool

Once you start tracing a particular database connection, InfoMaker continues sending trace output to the log until you do one of the following:

- Reconnect to the same database with tracing stopped
- Connect to another database for which you have not enabled tracing

To stop the Database Trace tool:

1. In the Database Profile Setup dialog box for the database you are tracing, clear the Generate Trace check box on the Connection tab.
2. Click OK in the Database Profile Setup dialog box.

The Database Profiles dialog box displays with the name of the edited profile highlighted.

3. Right-click on the connected database and select Re-connect from the dropdown menu in the Database Profiles dialog box.

InfoMaker connects to the database and stops tracing the connection.

9.2.4 Specifying a nondefault Database Trace log

In the InfoMaker development environment, you can specify a nondefault name and location for the log file when you use Database Trace.

What you can do

By specifying a nondefault Database Trace log to use in the development environment, you can:

- Control where InfoMaker writes the output of the Database Trace tool
- Give the log file a name and location that best meets the development needs at your site

By default, InfoMaker writes Database Trace output to a log file named PBTRACE.LOG located in your Windows directory. You can override this default in the development environment by editing your InfoMaker initialization file.

How to do it

To specify a nondefault Database Trace log file:

1. Open the InfoMaker initialization file for editing.
You can use the File Editor (in InfoMaker) or any text editor (outside InfoMaker).
2. Create an entry named DBTraceFile in the [Database] section of the initialization file, using the following syntax to specify a nondefault log file:

```
DBTraceFile=log_file_pathname
```

For example:

```
[Database]
...
DBTraceFile=c:\temp\mydbtrce.log
```

3. Save your changes to the initialization file.
The next time you use the Database Trace tool to trace a connection in the development environment, InfoMaker writes the output to the log file you specified instead of to the default PBTRACE.LOG file.

For instructions on starting Database Trace, see [Starting the Database Trace tool](#).

9.2.5 Using the Database Trace log

InfoMaker writes the output of the Database Trace tool to a file named PBTRACE.LOG (by default) or to a nondefault log file that you specify. To use the trace log, you can do the following anytime:

- View the Database Trace log with any text editor
- Annotate the Database Trace log with your own comments
- Delete the Database Trace log or clear its contents when it becomes too large

For information about where to find PBTRACE.LOG, see [Location of the Database Trace log](#).

For instructions about specifying your own Database Trace log to use in the development environment, see [Specifying a nondefault Database Trace log](#).

9.2.5.1 Viewing the Database Trace log

You can display the contents of the log file anytime during an InfoMaker session.

To view the contents of the log file:

1. Open the log file in one of the following ways:
2. Use the File Editor in InfoMaker. (For instructions, see the User's Guide.)

3. Use any text editor outside InfoMaker.

Leaving the log file open

If you leave the log file open as you work in InfoMaker, the Database Trace tool does not update the log.

9.2.5.2 Annotating the Database Trace log

When you use the Database Trace log as a troubleshooting tool, it might be helpful to add your own comments or notes to the file. For example, you can specify the date and time of a particular connection, the versions of database server and client software you used, or any other useful information.

To annotate the log file:

1. Open the PBTRACE.LOG file in one of the following ways:
 - Use the File Editor in InfoMaker. (For instructions, see the User's Guide.)
 - Use any text editor outside InfoMaker.
2. Edit the log file with your comments.
3. Save your changes to the log file.

9.2.5.3 Deleting or clearing the Database Trace log

Each time you connect to a database with tracing enabled, InfoMaker appends the trace output of your connection to the existing log. As a result, the log file can become very large over time, especially if you frequently enable tracing when connected to a database.

To keep the size of the log file manageable:

1. Do either of the following periodically:
2. Open the log file, clear its contents, and save the empty file.
3. Provided that you use the default PBTRACE.LOG or the same nondefault file the next time you connect to a database with tracing enabled, InfoMaker will write to this empty file.
4. Delete the log file.
5. InfoMaker will automatically create a new log file the next time you connect to a database with tracing enabled.

9.2.6 Sample Database Trace output

This section gives an example of Database Trace output that you might see in the log file and briefly explains each portion of the output.

The example traces a connection to an ODBC database named Sample. The output was generated while running an InfoMaker application that displays information about

employees in each department. The SELECT statement shown retrieves information from the Employee table to display the names of employees in department 100.

The precision (for example, milliseconds) used when Database Trace records internal commands depends on your operating system's timing mechanism. Therefore, the timing precision in your Database Trace log might vary from this example.

Connect to database

```
DIALOG CONNECT TO TRACE SYCAdaptive Server Enterprise:
USERID=
SERVER=HOST12
DATA=QATEST
DPPARM=Release='12'
```

Prepare SELECT statement

```
PREPARE:
SELECT employee.emp_id, employee.emp_lname,
employee.emp_fname, employee.dept_id FROM employee
WHERE ( employee.dept_id = 100 )
ORDER BY employee.emp_lname ASC (94 MilliSeconds)
```

Get column descriptions

```
DESCRIBE: (0 MilliSeconds)
name=emp_id, len=4, type=????, pbt5, dbt3, ct0, dec0
name=emp_lname, len=21, type=CHAR, pbt1, dbt1, ct0, dec0
name=emp_fname, len=21, type=CHAR, pbt1, dbt1, ct0, dec0
name=dept_id, len=4, type=????, pbt5, dbt3, ct0, dec0
```

Bind memory buffers to columns

```
BIND SELECT OUTPUT BUFFER (DataWindow):
(890 MilliSeconds)
name=emp_id, len=4, type=FLOAT, pbt3, dbt3, ct0, dec0
name=emp_lname, len=21, type=CHAR, pbt1, dbt1, ct0, dec0
name=emp_fname, len=21, type=CHAR, pbt1, dbt1, ct0, dec0
name=dept_id, len=4, type=FLOAT, pbt3, dbt3, ct0, dec0
```

Execute SELECT statement

```
EXECUTE: (0 MilliSeconds)
```

Fetch rows from result set

```
FETCH NEXT: (156 MilliSeconds)
emp_id= emp_lname=Jones emp_fname=Alan
dept_id=
FETCH NEXT: (0 MilliSeconds)
emp_id= emp_lname=Cicccone emp_fname=Peter
dept_id=
FETCH NEXT: (0 MilliSeconds)
emp_id= emp_lname=Houston emp_fname=Mary
dept_id=
FETCH NEXT: (0 MilliSeconds)
emp_id= emp_lname=Smith emp_fname=Susan
dept_id=
FETCH NEXT: (0 MilliSeconds)
emp_id= emp_lname=Stein emp_fname=David
dept_id=
FETCH NEXT: (0 MilliSeconds)
emp_id= emp_lname=Watson emp_fname=Linda
dept_id=
FETCH NEXT: (0 MilliSeconds)
```

```
Error 1 (rc 100)
```

Commit database changes

```
COMMIT: (55 MilliSeconds )
```

Disconnect from database

```
DISCONNECT: (0 MilliSeconds)
```

Shut down database interface

```
SHUTDOWN DATABASE INTERFACE: (203 MilliSeconds)
```

9.3 Using the ODBC Driver Manager Trace

This section describes how to use the ODBC Driver Manager Trace tool.

9.3.1 About ODBC Driver Manager Trace

You can use the ODBC Driver Manager Trace tool to trace a connection to any ODBC data source that you access in InfoMaker through the ODBC interface.

Unlike the Database Trace tool, the ODBC Driver Manager Trace tool cannot trace connections through one of the native database interfaces.

What this tool does

ODBC Driver Manager Trace records information about ODBC API calls (such as `SQLDriverConnect`, `SQLGetInfo`, and `SQLFetch`) made by InfoMaker while connected to an ODBC data source. It writes this information to a default log file named `SQL.LOG` or to a log file that you specify.

What both tools do

The information from ODBC Driver Manager Trace, like Database Trace, can help you:

- Understand what InfoMaker is doing internally while connected to an ODBC data source
- Identify and resolve problems with your ODBC connection
- Provide useful information to Technical Support if you call them for help with your database connection

When to use this tool

Use ODBC Driver Manager Trace instead of the Database Trace tool if you want more detailed information about the ODBC API calls made by InfoMaker.

Performance considerations

Turning on ODBC Driver Manager Trace can slow your performance while working in InfoMaker. Therefore, use ODBC Driver Manager Trace for debugging purposes only and keep it turned off when you are not debugging.

SQL.LOG file

InfoMaker writes ODBC Driver Manager Trace output to a default log file named `SQL.LOG` or to a log file that you specify. The default location of `SQL.LOG` is in your root directory.

9.3.2 Starting ODBC Driver Manager Trace

To start ODBC Driver Manager Trace in order to trace your ODBC connection, you must edit your database profile.

9.3.2.1 Starting ODBC Driver Manager Trace

To start ODBC Driver Manager Trace, edit the database profile for the connection you want to trace, as described in the following procedure.

To start ODBC Driver Manager Trace:

1. Open the Database Profile Setup-ODBC dialog box for the ODBC connection you want to trace.
2. On the Options tab, select the Trace ODBC API Calls check box.
3. (Optional) To specify a log file where you want InfoMaker to write the output of ODBC Driver Manager Trace, type the path name in the Trace File box.

or

(Optional) Click Browse to display the pathname of an existing log file in the Trace File box.

By default, if the Trace ODBC API Calls check box is selected and no trace file is specified, InfoMaker sends ODBC Driver Manager Trace output to the default SQL.LOG file.

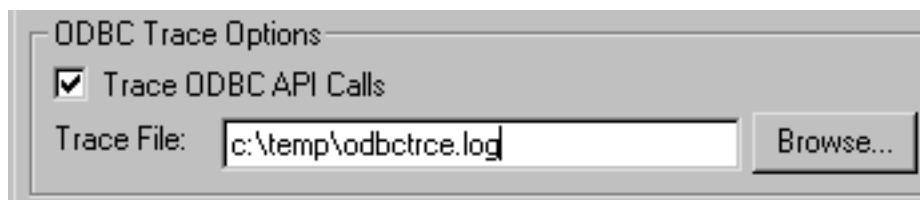

4. Click OK or Apply.

or

Right-click on the connected database and select Re-connect from the dropdown menu in the Database Profiles dialog box.

The Database Profiles dialog box displays with the name of the edited profile highlighted.

InfoMaker saves your settings in the database profile entry in the registry in the HKEY_CURRENT_USER\Software\Sybase\PowerBuilder\18.0\DatabaseProfiles key.

For example, here is the relevant portion of a database profile entry for an ODBC data source named Employee. The settings that start ODBC Driver Manager Trace (corresponding to the ConnectOption DBParm parameter) are emphasized.

```
DBMS      "ODBC"
...
DbParm    "ConnectionString='DSN=Employee;UID=dba;
PWD=00c61737',ConnectOption='SQL_OPT_TRACE,SQL_OPT_TRACE_ON;SQL_OPT_TRACEFILE,C:
\Temp\odbctrce.log'"
```

5. Click Connect in the Database Profiles dialog box to connect to the database.

or

Right-click on the connected database and select Re-connect from the dropdown menu in the Database Profiles dialog box.

InfoMaker connects to the database, starts tracing the ODBC connection, and writes output to the log file you specified.

9.3.3 Stopping ODBC Driver Manager Trace

Once you start tracing an ODBC connection with ODBC Driver Manager Trace, InfoMaker continues sending trace output to the log file until you stop tracing. After you stop tracing as described in the following sections, you must reconnect to have the changes take effect.

9.3.3.1 Stopping ODBC Driver Manager Trace

To stop ODBC Driver Manager Trace:

1. Open the Database Profile Setup - ODBC dialog box for the connection you are tracing.

For instructions, see [Starting ODBC Driver Manager Trace](#).

2. On the Options tab, clear the Trace ODBC API Calls check box.

If you supplied the pathname of a log file in the Trace File box, you can leave it specified in case you want to restart tracing later.

3. Click OK in the Database Profile Setup - ODBC dialog box.

The Database Profiles dialog box displays, with the name of the edited profile highlighted.

4. Click Connect in the Database Profiles dialog box.

or

Right-click on the connected database and select Re-connect from the dropdown menu in the Database Profiles dialog box.

InfoMaker connects to the database and stops tracing the connection.

9.3.4 Viewing the ODBC Driver Manager Trace log

You can display the contents of the ODBC Driver Manager Trace log file anytime during an InfoMaker session.

Location of SQL.LOG

For information about where to find the default SQL.LOG file, see [About ODBC Driver Manager Trace](#).

To view the contents of the log file:

1. Open SQL.LOG or the log file you specified in one of the following ways:

2. Use the File Editor in InfoMaker. (For instructions, see the User's Guide.)
3. Use any text editor outside InfoMaker.

Leaving the log file open

If you leave the log file open as you work in InfoMaker, ODBC Driver Manager Trace does not update it.

9.3.5 Sample ODBC Driver Manager Trace output

This section shows a partial example of output from ODBC Driver Manager Trace to give you an idea of the information it provides. The example is part of the trace on an ODBC connection to the PB Demo DB.

For more about a particular ODBC API call, see your ODBC documentation.

```

PB100 179:192  EXIT  SQLSetConnectOption  with return code 0 (SQL_SUCCESS)
          HDC 0x036e1300      UWORD      104 <SQL_OPT_TRACE>
          UDWORD 1

PB100 179:192  ENTER SQLSetConnectOption
          HDC 0x036e1300      UWORD 105 <SQL_OPT_TRACEFILE>
          UDWORD 160694373PB100 179:192  EXIT  SQLSetConnectOption  with return code 0
(SQL_SUCCESS)
          HDC 0x036e1300      UWORD 105 <SQL_OPT_TRACEFILE>
          UDWORD 160694373PB100 179:192  ENTER SQLDriverConnectW
          HDC 0x036e1300      HWND 0x004607fa  WCHAR * 0x1f4be068 [ -3] "*****\ 0"
          SWORD -3
          WCHAR * 0x1f4be068
          SWORD 8
          SWORD * 0x00000000  UWORD 1 <SQL_DRIVER_COMPLETE>
PB100 179:192  EXIT  SQLDriverConnectW  with return code 0 (SQL_SUCCESS)
          HDC 0x036e1300      HWND 0x004607fa  WCHAR * 0x1f4be068 [ -3] "*****\ 0"
          SWORD -3
          WCHAR * 0x1f4be068
          SWORD 8
          SWORD * 0x00000000  UWORD 1 <SQL_DRIVER_COMPLETE>
PB100 179:192  ENTER SQLGetInfoW
          HDC 0x036e1300      UWORD 6 <SQL_DRIVER_NAME>
          PTR 0x036e2098
          SWORD 6
          SWORD * 0x0012cd30PB100 179:192  EXIT  SQLGetInfoW  with return code 1
(SQL_SUCCESS_WITH_INFO)
          HDC 0x036e1300      UWORD 6 <SQL_DRIVER_NAME>
          PTR 0x036e2098 [ 6] "DB\ 0"
          SWORD 6
          SWORD * 0x0012cd30 (22)
          DIAG [01004] [Sybase][ODBC Driver]Data truncated (0)
PB100 179:192  ENTER SQLGetInfoW
          HDC 0x036e1300      UWORD 10 <SQL_ODBC_VER>
          PTR 0x036e39f8
          SWORD 100
          SWORD * 0x0012cd38PB100 179:192  EXIT  SQLGetInfoW  with return code 0
(SQL_SUCCESS)
          HDC 0x036e1300      UWORD 10 <SQL_ODBC_VER>
          PTR 0x036e39f8 [ 20] "03.51.0000"
          SWORD 100
          SWORD * 0x0012cd38 (20)
PB100 179:192  ENTER SQLGetInfoW
          HDC 0x036e1300      UWORD 2 <SQL_DATA_SOURCE_NAME>
          PTR 0x036e3c88

```

```

SWORD 512
SWORD * 0x0012cc32PB100 179:192  EXIT  SQLGetInfoW  with return code 0
(SQL_SUCCESS)
HDBC 0x036e1300      UWORD 2 <SQL_DATA_SOURCE_NAME>
PTR 0x036e3c88 [    28] "PB Demo DB V4"
SWORD 512
SWORD * 0x0012cc32 (28)
PB100 179:192  ENTER  SQLGetInfoW
HDBC 0x036e1300      UWORD 16 <SQL_DATABASE_NAME>
PTR 0x036e3c88
SWORD 512
SWORD * 0x0012cc32PB100 179:192  EXIT  SQLGetInfoW  with return code 0
(SQL_SUCCESS)
HDBC 0x036e1300      UWORD 16 <SQL_DATABASE_NAME>
PTR 0x036e3c88 [    16] "easdemo4"
SWORD 512
SWORD * 0x0012cc32 (16)
PB100 179:192  ENTER  SQLGetInfoW
HDBC 0x036e1300      UWORD 25 <SQL_DATA_SOURCE_READ_ONLY>
PTR 0x036e3c88
SWORD 512
SWORD * 0x0012cc32PB100 179:192  EXIT  SQLGetInfoW  with return code 0
(SQL_SUCCESS)
HDBC 0x036e1300      UWORD 25 <SQL_DATA_SOURCE_READ_ONLY>
PTR 0x036e3c88 [    2] "N"
SWORD 512
SWORD * 0x0012cc32 (2)
PB100 179:192  ENTER  SQLGetInfoW
HDBC 0x036e1300      UWORD 13 <SQL_SERVER_NAME>
PTR 0x036e3c88
SWORD 512
SWORD * 0x0012cc32PB100 179:192  EXIT  SQLGetInfoW  with return code 0
(SQL_SUCCESS)
HDBC 0x036e1300      UWORD 13 <SQL_SERVER_NAME>
PTR 0x036e3c88 [    16] "easdemo4"
SWORD 512
SWORD * 0x0012cc32 (16)
PB100 179:192  ENTER  SQLGetInfoW
HDBC 0x036e1300      UWORD 17 <SQL_DBMS_NAME>
PTR 0x036e3c88
SWORD 512
SWORD * 0x0012cab6PB100 179:192  EXIT  SQLGetInfoW  with return code 0
(SQL_SUCCESS)
HDBC 0x036e1300      UWORD 17 <SQL_DBMS_NAME>
PTR 0x036e3c88 [   48] "SQL Anywhere"
SWORD 512
SWORD * 0x0012cab6 (48)
PB100 179:192  ENTER  SQLGetInfoW
HDBC 0x036e1300      UWORD 6 <SQL_DRIVER_NAME>
PTR 0x036e1a10
SWORD 550
SWORD * 0x0012cbbcPB100 179:192  EXIT  SQLGetInfoW  with return code 0
(SQL_SUCCESS)
HDBC 0x036e1300      UWORD 6 <SQL_DRIVER_NAME>
PTR 0x036e1a10 [   22] "DBODBC7.DLL"
SWORD 550
SWORD * 0x0012cbbc (22)
PB100 179:192  ENTER  SQLAllocStmt
HDBC 0x036e1300      HSTMT * 0x0012d0b4
PB100 179:192  EXIT  SQLAllocStmt  with return code 0 (SQL_SUCCESS)
HDBC 0x036e1300      HSTMT * 0x0012d0b4 ( 0x036e1c48)
PB100 179:192  ENTER  SQLGetTypeInfo
HSTMT 0x036e1c48      SWORD 0 <SQL_ALL_TYPES>

```

9.4 Using the JDBC Driver Manager Trace

This section describes how to use the JDBC Driver Manager Trace tool.

9.4.1 About JDBC Driver Manager Trace

You can use the JDBC Driver Manager Trace tool to trace a connection to any database that you access in InfoMaker through the JDBC interface.

Unlike the Database Trace tool, the JDBC Driver Manager Trace tool cannot trace connections through one of the native database interfaces.

What this tool does

JDBC Driver Manager Trace logs errors and informational messages originating from the Driver object currently loaded (such as SAP Sybase's jConnect JDBC driver) when InfoMaker connects to a database through the JDBC interface. It writes this information to a default log file named JDBC.LOG or to a log file that you specify. The amount of trace output varies depending on the JDBC driver being used.

What both tools do

The information from JDBC Driver Manager Trace, like Database Trace, can help you:

- Understand what InfoMaker is doing internally while connected to a database through the JDBC interface
- Identify and resolve problems with your JDBC connection
- Provide useful information to Technical Support if you call them for help with your database connection

When to use this tool

Use JDBC Driver Manager Trace instead of the Database Trace tool if you want more detailed information about the JDBC driver.

Performance considerations

Turning on JDBC Driver Manager Trace can slow your performance while working in InfoMaker. Therefore, use JDBC Driver Manager Trace for debugging purposes only and keep it turned off when you are not debugging.

JDBC.LOG file

InfoMaker writes JDBC Driver Manager Trace output to a default log file named JDBC.LOG or to a log file that you specify. The default location of JDBC.LOG is a temp directory.

9.4.2 Starting JDBC Driver Manager Trace

To start JDBC Driver Manager Trace in order to trace your JDBC connection, you must edit your database profile.

9.4.2.1 Starting JDBC Driver Manager Trace

To start JDBC Driver Manager Trace, edit the database profile for the connection you want to trace, as described in the following procedure.

To start JDBC Driver Manager Trace:

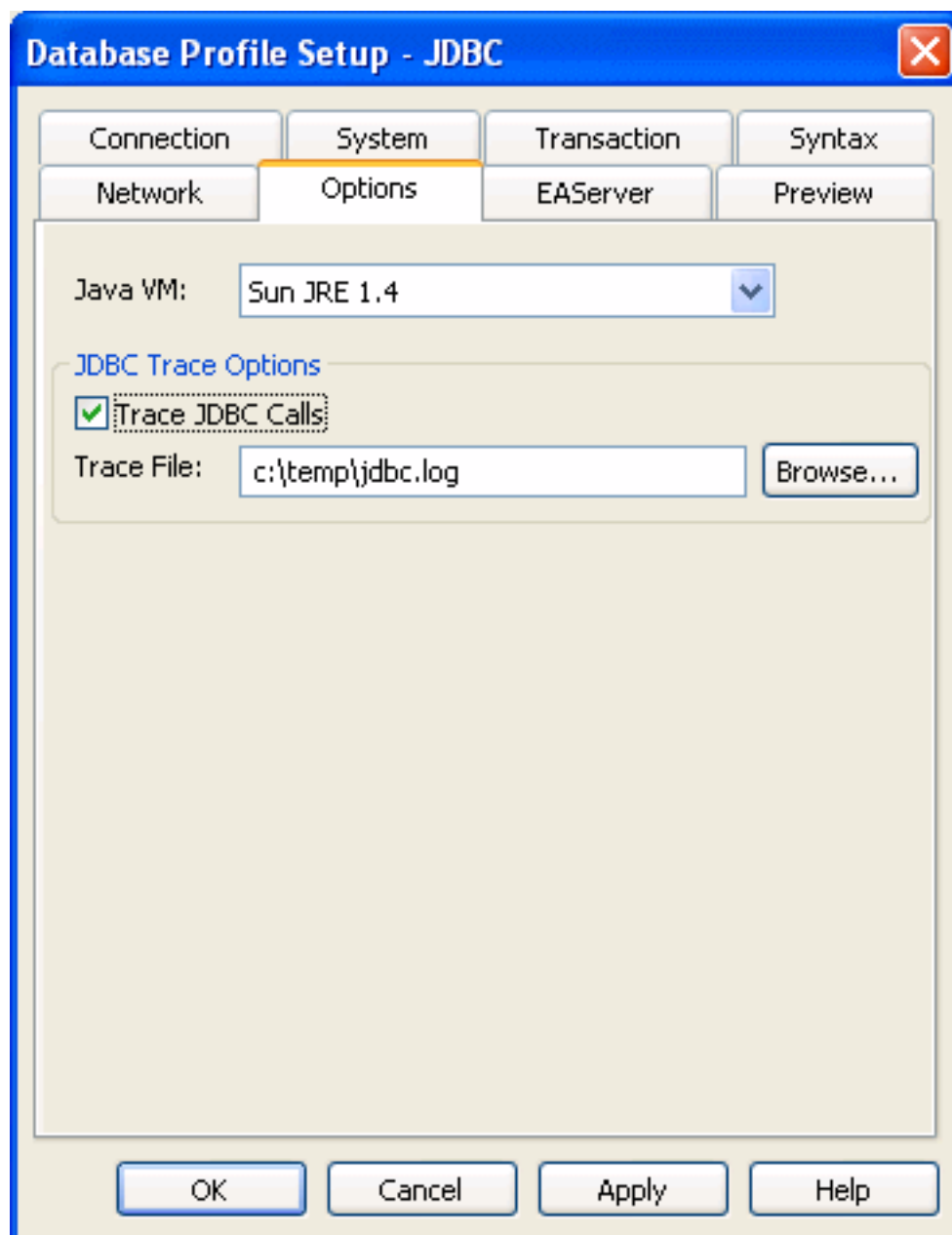

Preview tab not in InfoMaker

The Preview tab is not available in the Database Profile Setup dialog box in InfoMaker.

1. Open the Database Profile Setup - JDBC dialog box for the JDB connection you want to trace.
2. On the Options tab, select the Trace JDBC Calls check box.

- (Optional) To specify a log file where you want InfoMaker to write the output of JDBC Driver Manager Trace, type the pathname in the Trace File box.

or

(Optional) Click Browse to display the pathname of an existing log file in the Trace File box.

By default, if the Trace JDBC Calls check box is selected and no alternative trace file is specified, InfoMaker sends JDBC Driver Manager Trace output to the default JDBC.LOG file.

- Click OK or Apply.

The Database Profiles dialog box displays with the name of the edited profile highlighted.

InfoMaker saves your settings in the database profile entry in the registry.

For example, here are the DBMS and DBParm string values of a database profile entry for a database named Employee. The settings that start JDBC Driver Manager Trace (corresponding to the TraceFile DBParm parameter) are emphasized.

```
DBMS      "TRACE JDBC"
DbParm    "Driver='com.sybase.jdbc.SybDriver',
          URL='jdbc:sybase:Tds:199.93.178.151:
          5007/tsdata',JavaVM='Sun1.3',TraceFile=
          'c:\temp\jdbc.log'"
```

- Click Connect in the Database Profiles dialog box to connect to the database.

or

Right-click on the connected database and select Re-connect from the dropdown menu in the Database Profiles dialog box.

InfoMaker connects to the database, starts tracing the JDBC connection, and writes output to the log file you specified.

9.4.3 Stopping JDBC Driver Manager Trace

Once you start tracing a JDBC connection with JDBC Driver Manager Trace, InfoMaker continues sending trace output to the log file until you stop tracing.

9.4.3.1 Stopping JDBC Driver Manager Trace

To stop JDBC Driver Manager Trace:

- Open the Database Profile Setup - JDBC dialog box for the connection you are tracing.
For instructions, see [Starting JDBC Driver Manager Trace](#).
- On the Options tab, clear the Trace JDBC Calls check box.
If you supplied the pathname of a log file in the Trace File box, you can leave it specified in case you want to restart tracing later.
- Click OK in the Database Profile Setup - JDBC dialog box.

The Database Profiles dialog box displays, with the name of the edited profile highlighted.

4. Click Connect in the Database Profiles dialog box.

or

Right click on the connected database and select Re-connect from the dropdown menu in the Database Profiles dialog box.

InfoMaker connects to the database and stops tracing the connection.

9.4.4 Viewing the JDBC Driver Manager Trace log

You can display the contents of the JDBC Driver Manager Trace log file anytime during an InfoMaker session.

Location of JDBC.LOG

For information about where to find the default JDBC.LOG file, see [About JDBC Driver Manager Trace](#).

To view the contents of the log file:

1. Open JDBC.LOG or the log file you specified in one of the following ways:
2. Use the File Editor in InfoMaker. (For instructions, see the User's Guide.)
3. Use any text editor outside InfoMaker.

Leaving the log file open

If you leave the log file open as you work in InfoMaker, JDBC Driver Manager Trace does not update the log.

Part V. Appendix

The Appendix describes how to modify the PBODB190 initialization file.

Appendix A. Adding Functions to the PBODB190 Initialization File

About this appendix

In general, you do not need to modify the PBODB190 initialization file. In certain situations, however, you might need to add functions to the PBODB190 initialization file for connections to your back-end DBMS through the ODBC interface in InfoMaker.

This appendix describes how to add functions to the PBODB190 initialization file if necessary.

A.1 About the PBODB190 initialization file

What is the PBODB190 initialization file?

When you access data through the ODBC interface, InfoMaker uses the PBODB190 initialization file (PBODB190.INI) to maintain access to extended functionality in the back-end DBMS for which ODBC does not provide an API call. Examples of extended functionality are SQL syntax or function calls specific to a particular DBMS.

See also: [Where is PBODB190.INI?](#)

Editing PBODB190.INI

In most cases, you do not need to modify PBODB190.INI. Changes to this file can adversely affect InfoMaker. Change PBODB190.INI only if you are asked to do so by a Technical Support representative.

However, you can edit PBODB190.INI if you need to add functions for your back-end DBMS.

If you modify PBODB190.INI, first make a copy of the existing file. Then keep a record of all changes you make. If you call Technical Support after modifying PBODB190.INI, tell the representative that you changed the file and describe the changes you made.

A.1.1 Adding functions to PBODB190.INI

PBODB190.INI lists the functions for certain DBMSs that have ODBC drivers. If you need to add a function to PBODB190.INI for use with your back-end DBMS, you can do either of the following:

- Existing sections

Add the function to the Functions section for your back-end database if this section exists in PBODB190.INI.

- New sections

Create new sections for your back-end DBMS in PBODB190.INI and add the function to the newly created Functions section.

A.1.1.1 Adding functions to an existing section in the file

If sections for your back-end DBMS already exist in PBODB190.INI, use the following procedure to add new functions.

To add functions to an existing section in PBODB190.INI:

1. Open PBODB190.INI in one of the following ways:
 - Use the File Editor in InfoMaker. (For instructions, see the User's Guide.)
 - Use any text editor outside InfoMaker.
2. Locate the entry for your back-end DBMS in the DBMS Driver/DBMS Settings section of PBODB190.INI.

For example, here is the PBODB190.INI entry for SQL Anywhere:

```

;*****
;DBMS Driver/DBMS Settings see comments at end
;of file
;*****
...
[SQL Anywhere]
PBSyntax='WATCOM50_SYNTAX'
PBDateTime='STANDARD_DATETIME'
PBFunctions='SQL Anywhere_FUNCTIONS'
PBDefaultValues='autoincrement,current date,
                current time,current timestamp,timestamp,
                null,user'
PBDefaultCreate='YES'
PBDefaultAlter='YES'
PBDefaultExpressions='YES'
DelimitIdentifier='YES'
PBDateTimeInvalidInSearch='NO'
PBTimeInvalidInSearch='YES'
PBQualifierIsOwner='NO'
PBSpecialDataTypes='WATCOM_SPECIALDATATYPES'
IdentifierQuoteChar=''
PBSystemOwner='sys,dbo'
PBUseProcOwner='YES'
SQLSrvrTSName='YES'
SQLSrvrTSQuote='YES'
SQLSrvrTSDelimit='YES'
ForeignKeyDeleteRule='Disallow if Dependent Rows
                      Exist (RESTRICT),Delete any Dependent Rows
                      (CASCADE),Set Dependent Columns to NULL
                      (SET NULL)'
TableListType='GLOBAL TEMPORARY'

```

3. Find the name of the section in PBODB190.INI that contains function information for your back-end DBMS.

To find this section, look for a line similar to the following in the DBMS Driver/DBMS Settings entry:

```
PBFunctions='section_name'
```

For example, the following line in the DBMS Driver/DBMS Settings entry for SQL Anywhere indicates that the name of the Functions section is ASA_FUNCTIONS:

```
PBFunctions='ASA_FUNCTIONS'
```

4. Find the Functions section for your back-end DBMS in PBODB190.INI.

For example, here is the Functions section for SQL Anywhere:

```

;*****
;Functions
;*****
[ASA_FUNCTIONS]
AggrFuncs=avg(x),avg(distinct x),count(x),
          count(distinct x),count(*),list(x),
          list(distinct x),max(x),max(distinct x),
          min(x),min(distinct x),sum(x),sum(distinct x)
Functions=abs(x),acos(x),asin(x),atan(x),
          atan2(x,y),ceiling(x),cos(x),cot(x),degrees(x),
          exp(x),floor(x),log(x),log10(x),
          mod(dividend,divisor),pi(*),power(x,y),
          radians(x),rand(),rand(x),
          remainder(dividend,divisor),round(x,y),
          sign(x),sin(x),sqrt(x),tan(x),
          "truncate"(x,y),ascii(x),byte_length(x),
          byte_substr(x,y,z),char(x),char_length(x),
          charindex(x,y),difference(x,y),insertstr(x,y,z),
          lcase(x),left(x,y),length(x),locate(x,y,z),
          lower(x),ltrim(x),patindex('x',y),repeat(x,y),
          replicate(x,y),right(x,y),rtrim(x),
          similar(x,y),soundex(x),space(x),str(x,y,z),
          string(x,...),stuff(w,x,y,z),substr(x,y,z),
          trim(x),ucase(x),upper(x),date(x),
          dateformat(x,y),datename(x,y),day(x),
          dayname(x),days(x),dow(x),hour(x),hours(x),
          minute(x),minutes(x),minutes(x,y),month(x),
          monthname(x),months(x),months(x,y),now(*),
          quarter(x),second(x),seconds(x),seconds(x,y),
          today(*),weeks(x),weeks(x,y),year(x),years(x),
          years(x,y),ymd(x,y,z),dateadd(x,y,z),
          datediff(x,y,z),datename(x,y),datepart(x,y),
          getdate(),cast(x as y),convert(x,y,z),
          hextoint(x),inttohex(x),
          connection_property(x,...),datalength(x),
          db_id(x),db_name(x),db_property(x),
          next_connection(x),next_database(x),
          property(x),property_name(x),
          property_number(x),property_description(x),
          argn(x,y,...),coalesce(x,...),
          estimate(x,y,z),estimate_source(x,y,z),
          experience_estimate(x,y,z),ifnull(x,y,z),
          index_estimate(x,y,z),isnull(x,...),
          number(*),plan(x),traceback(*)

```

5. To add a new function, type a comma followed by the function name at the end of the appropriate function list, as follows:

- Aggregate functions

Add aggregate functions to the end of the AggrFuncs list.

- All other functions

Add all other functions to the end of the Functions list.

Case sensitivity

If the back-end DBMS you are using is case sensitive, be sure to use the required case when you add the function name. The following example shows a new function for SQL Anywhere added at the end of the Functions list:

```

;*****
;Functions
;*****
[ASA_FUNCTIONS]
AggrFuncs=avg(x),avg(distinct x),count(x),
           count(distinct x),count(*),list(x),
           list(distinct x),max(x),max(distinct x),
           min(x),min(distinct x),sum(x),sum(distinct x)
Functions=abs(x),acos(x),asin(x),atan(x),
           atan2(x,y),ceiling(x),cos(x),cot(x),degrees(x),
           exp(x),floor(x),log(x),log10(x),
           mod(dividend,divisor),pi(*),power(x,y),
           radians(x),rand(),rand(x),
           ...
           number(*),plan(x),traceback(*),newfunction()

```

-
6. Save your changes to PBODB190.INI.

A.1.1.2 Adding functions to a new section in the file

If entries for your back-end DBMS do not exist in PBODB190.INI, use the following procedure to create the required sections and add the appropriate functions.

Before you start

For more about the settings to supply for your back-end DBMS in PBODB190.INI, read the comments at the end of the file.

To add functions to a new section in PBODB190.INI:

1. Open PBODB190.INI in one of the following ways:
 - Use the File Editor in InfoMaker. (For instructions, see the User's Guide.)
 - Use any text editor outside InfoMaker.
 2. Edit the DBMS Driver/DBMS Settings section of the PBODB190 initialization file to add an entry for your back-end DBMS.
-

Finding the name

The name required to identify the entry for your back-end DBMS in the DBMS Driver/DBMS Settings section is in PBODB190.INI.

Make sure that you:

- Follow the instructions in the comments at the end of PBODB190.INI.

- Use the same syntax as existing entries in the DBMS Driver/DBMS Settings section of PBODB190.INI.
- Include a section name for PBFunctions.

For example, here is the relevant portion of an entry for a DB2/2 database:

```
;*****
;DBMS Driver/DBMS Settings
;*****
[DB2/2]
...
PBFunctions='DB22_FUNCTIONS'
...
```

3. Edit the Functions section of PBODB190.INI to add an entry for your back-end DBMS.

Make sure that you:

- Follow the instructions in the comments at the end of PBODB190.INI.
- Use the same syntax as existing entries in the Functions section of PBODB190.INI.
- Give the Functions section the name that you specified for PBFunctions in the DBMS Driver/DBMS Settings entry.

For example:

```
;*****
;Functions
;*****
[DB22_FUNCTIONS]
AggrFuncs=avg(),count(),list(),max(),min(),sum()
Functions=curdate(),curtime(),hour(), ...
```

4. Type a comma followed by the function name at the end of the appropriate function list, as follows:

- Aggregate functions
Add aggregate functions to the end of the AggrFuncs list.
- All other functions
Add all other functions to the end of the Functions list.

Case sensitivity

If the back-end DBMS you are using is case sensitive, be sure to use the required case when you add the function name. The following example shows (in bold) a new DB2/2 function named **substr()** added at the end of the Functions list:

```
;*****
;Functions
;*****
```



```
[DB22_FUNCTIONS]
```

```
AggrFuncs=avg(),count(),list(),max(),min(),sum()
```

```
Functions=curdate(),curtime(),hour(), substr()
```

5. Save your changes to PBODB190.INI.

Index

A

- Adaptive Server
 - software components, [83](#)
 - supported data types, [82](#)
 - supported versions, [82](#)
- Adaptive Server database
 - prepare to use, [84](#)
- Adaptive Server database interface
 - define, [86](#)
- Adaptive Server stored procedures
 - use Print statement, [91](#)
- ADO.NET
 - about, [44](#)
- ADO.NET connection
 - components, [45](#)
- ADO.NET interface
 - define, [48](#)
 - prepare to use, [47](#)

C

- connection parameters
 - set, [124](#)

D

- database connections
 - about, [107](#)
- database interface connection
 - component, [51](#)
- database parameters
 - set, [125](#)
- database preferences
 - set, [125](#)
- Database Profile Setup dialog box, [125](#)
- database profiles
 - about, [5](#)
 - create, [8](#)
 - import and export, [116](#)
 - maintain, [112](#)
 - select, [110](#)
 - share, [112](#)
 - specify passwords, [111](#)
 - use, [4](#), [109](#)
- Database profiles registry entry, [21](#)
- Database Trace log
 - specify, [134](#)
 - use, [135](#)

- Database Trace output
 - sample, [136](#)
- Database Trace tool
 - about, [131](#)
 - start, [133](#)
 - stop, [134](#)
- DB2SYSPB.SQL script, [104](#)
- demo database
 - access, [4](#)
- DirectConnect database
 - prepare to use, [101](#)
- DirectConnect interface
 - define, [103](#)
 - software components, [98](#)
 - supported data types, [101](#)
 - supported versions, [100](#)
 - use, [97](#)

E

- extended attribute system tables
 - about, [117](#)
 - contents, [120](#)
 - control access, [121](#)
 - create, [104](#)
 - display, [118](#)

I

- InfoMaker stored procedure scripts, [92](#)
- Informix
 - DateTime data type, [54](#)
 - Interval data type, [55](#)
 - software components, [55](#)
 - supported data types, [54](#)
 - supported versions, [53](#)
 - Time data type, [55](#)
- Informix database
 - prepare to use, [56](#)
- Informix database interface
 - define, [57](#)

J

- JDBC
 - supported data types, [34](#)
 - supported versions, [34](#)
- JDBC connection
 - components, [32](#)
- JDBC Driver Manager Trace
 - about, [143](#)
 - start, [143](#)

- stop, [145](#)
 - JDBC Driver Manager Trace log
 - view, [146](#)
 - JDBC interface
 - about, [31](#)
 - define, [35](#)
 - prepare to use, [34](#)
 - JDBC registry entries, [33](#)
- N**
- native database interface
 - use, [52](#)
 - native database interfaces
 - about, [51](#)
- O**
- ODBC connection
 - components, [12](#)
 - ODBC data sources
 - define, [19](#)
 - multiple data sources, [22](#)
 - prepare, [18](#)
 - ODBC Driver Manager Trace
 - about, [138](#)
 - start, [139](#)
 - stop, [140](#)
 - ODBC Driver Manager Trace log
 - view, [140](#)
 - ODBC Driver Manager Trace output
 - sample, [141](#)
 - ODBC drivers
 - conformance levels, [16](#)
 - obtain, [18](#)
 - types, [14](#)
 - ODBC interface
 - define, [23](#)
 - use, [11](#)
 - ODBC registry entries, [20](#)
 - ODBC translator
 - select, [23](#)
 - ODBCINST registry entries, [20](#)
 - OLE DB
 - supported versions, [40](#)
 - OLE DB connection
 - components, [39](#)
 - OLE DB data providers, [46](#)
 - obtain, [40](#)
 - OLE DB interface
 - about, [37](#)
 - define, [42](#)
 - prepare to use, [41](#)
 - Open Client directory services
 - use, [89](#)
 - Open Client security services
 - use, [87](#)
 - Oracle
 - software components, [73](#)
 - supported data types, [72](#)
 - supported versions, [72](#)
 - Oracle database
 - prepare to use, [74](#)
 - Oracle database interface
 - define, [76](#)
 - Oracle stored procedures
 - use as data source, [77](#)
 - Oracle user-defined types
 - use, [80](#)
- P**
- PBODB190 initialization file, [19](#)
 - about, [148](#)
 - add functions, [148](#)
 - PostgreSQL, [29](#)
- S**
- shared database profiles
 - about, [112](#)
 - maintain, [116](#)
 - make local changes, [115](#)
 - set up, [113](#)
 - use to connect, [114](#)
 - SQL Anywhere
 - software components, [24](#)
 - supported versions, [24](#)
 - Transact-SQL special timestamp columns, [28](#)
 - SQL Anywhere data source
 - define, [26](#)
 - prepare to use, [25](#)
 - SQL Server
 - 2008 features, [65](#)
 - software components, [59](#)
 - supported data types, [59](#)
 - supported versions, [58](#)
 - use SNC interface, [71](#)
 - SQL Server database
 - prepare to use, [60](#)
 - SQL Server database interface

define, [62](#)